



GYRO FRAME 2 WARMDIM

220-240V 50/60Hz 300mA LED 2x9W IP44*

EN: MEASUREMENT

NO: MÅL
 SE: MÅTT
 FI: MITAT

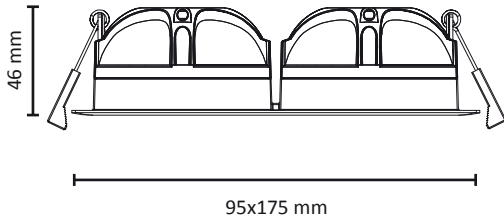

Cut out: Ø82-84

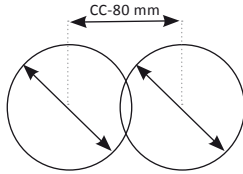

EN: Installation must be performed by a qualified electrician.

OBS! NO: Må installeres av autorisert el-installerør.
 SE: Måste installeras av en behörig elinstallatör.
 FI: Vain valtuutettu sähköasentaja saa asentaa.

EN: CABLE CONNECTION

NO: LEDNINGSTILKOBING
 SE: KABELANSLUTNING
 FI: JOHTOLIITÄNTÄ

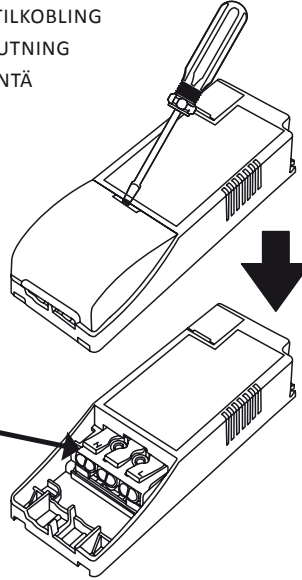

Max. 16A
 Max. 2,5mm²

EN: Included dimmable LED driver.
 NO: Inkludert dimbar LED driver.
 SE: Inklusive dimbar LED drivdon.
 FI: Sisältää himmennettävän LED-liitäntälaitteen.

EN: CORRESPONDING PRODUCT.

NO: TILHØRENDE PRODUKT.
 SE: TILLHÖRANDE PRODUKT.
 FI: AIHEESEEN LIITTYVÄ TUOTE.

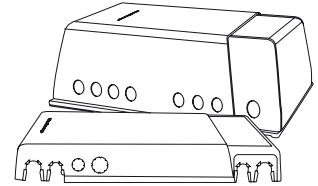

NO EL.NR:	SE E.NR:	FI S.NRO:	DOWNLIGHT BOX:
32 249 20	74 657 18	N/A	DL BOX HIGH
32 249 21	74 657 19	N/A	DL BOX LOW
BRAND:			LUZENSE

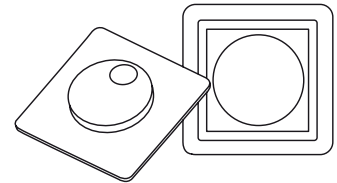

NO EL.NR:	SE E.NR:	FI S.NRO:	DOWNLIGHT BOX:
14 059 01	13 602 79	26 151 00	KDT-500E 1 POLE
14 059 02	13 602 80	N/A	KDT-500E 2 POLE
14 059 03	13 602 40	26 151 01	UNIVERSAL KDT-500IE
14 059 08	13 602 81	26 151 02	DUO 2X100W
14 059 61	13 602 82	26 151 04	IMPULS/PUSH 200W
14 059 70	13 602 83	26 151 05	WIDIM A WALL 250W
14 059 80	13 602 85	26 151 06	WIDIM C WIFI-SWITCH
BRAND:			LUZENSE



EN: White/black may be used indoors and outdoors.
 NO: Hvit/sort kan benyttes innendørs og utendørs.
 SE: Vit/Svart kan användas inomhus och utomhus.
 FI: Valkoinen/musta sisä- ja ulkokäyttöön.

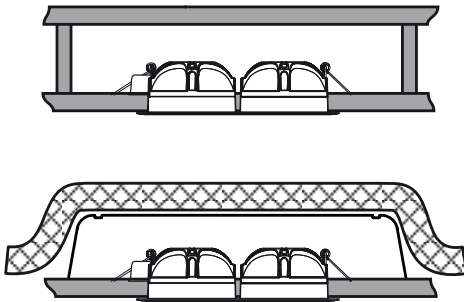

EN: May be covered by insulation sheet.
 NO: Kan overdekkes av isolasjonsmatter.
 SE: Kan övertäckas av isolationsmattor.
 FI: Voi peittää eristysmatolla.

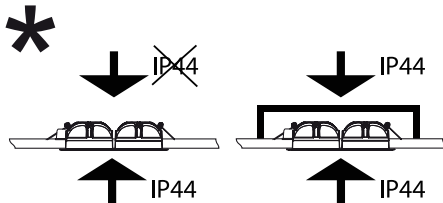

EN: IP44 from the luminaire underside.
 NO: IP44 fra armaturens underside.
 SE: IP44 från armaturens underside.
 FI: IP44 valaisimen alapuolelta.

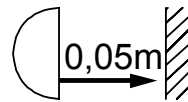

EN: Minimum distance to flammable material in the beam direction.
 NO: Minimumsavstand til brennbart materiale i armaturens stråleretning.
 SE: Minsta avstånd mellan brännbart material och lampans ljusrättning.
 FI: Vähimmäismitta lampusta palaavaan materiaaliin.