



TF 240/50 -jatkoskotelon asentaminen



TF 240/50

**Vetolankojen
kiinnityslevyt**

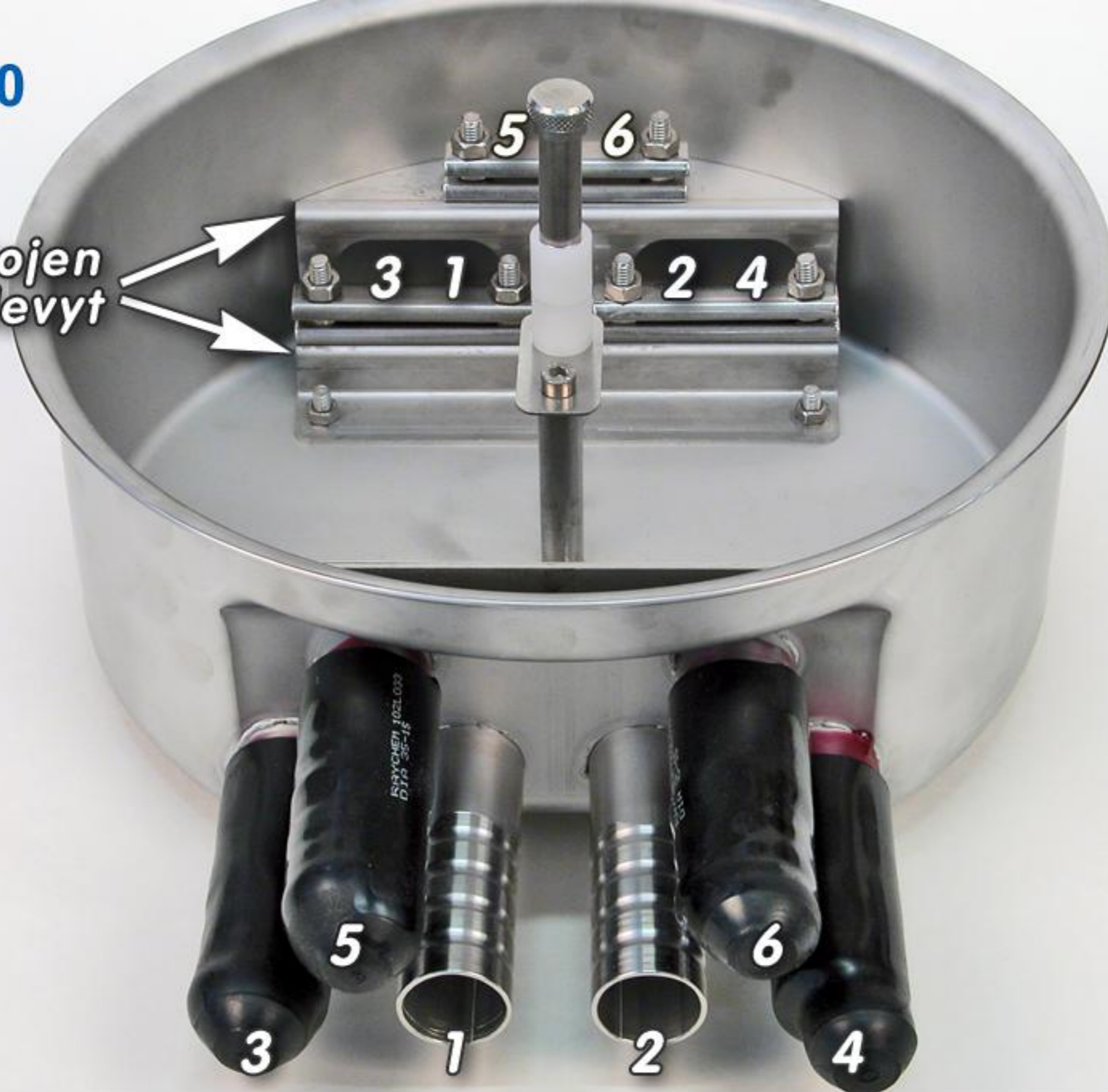



Smirgeli-
kangas

Kufisteletkuja 2 kpl

Multikasetti -jatkoslevyjä 2 kpl

Suojaputkia
(330 mm) 12 kpl

Kuitujatkosholkkeja
(45 mm) 50 kpl

Jakokappaleita 6 kpl

Puhdistusliina
1 kpl

Kuivausaine-
pakkaus 1 kpl

"Oetiker" -kiristimiä

Nippusiteitä 25 kpl

Alumiinisia
liekinsuojia 2 kpl

Maadoituskenkä ja mutteri 1 kpl

Kierteensuojia 4 kpl

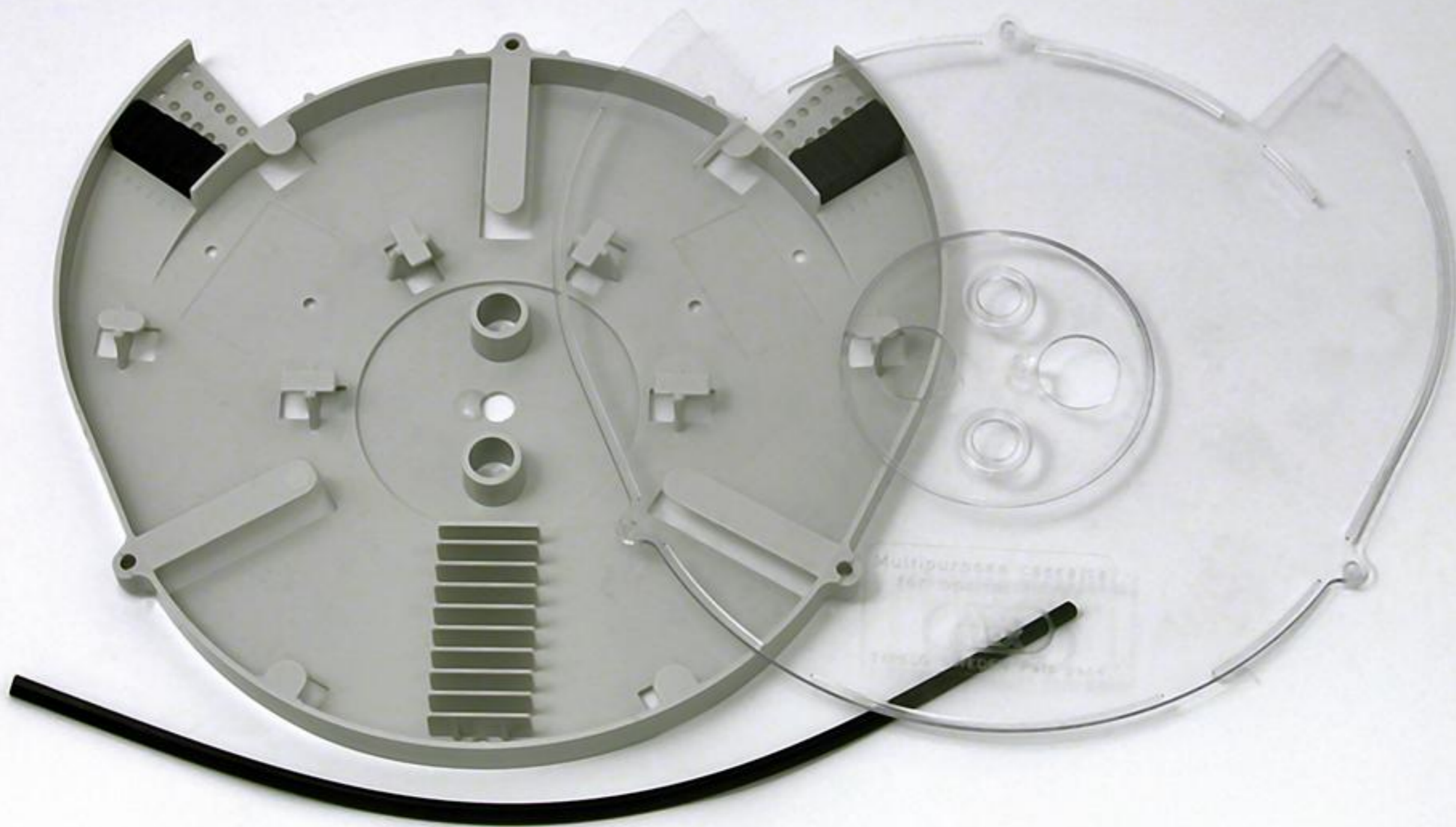

Kuitujen jatkossuojahylsyt kiinnitetään pitimeen kumimuotonauhan pätkällä.

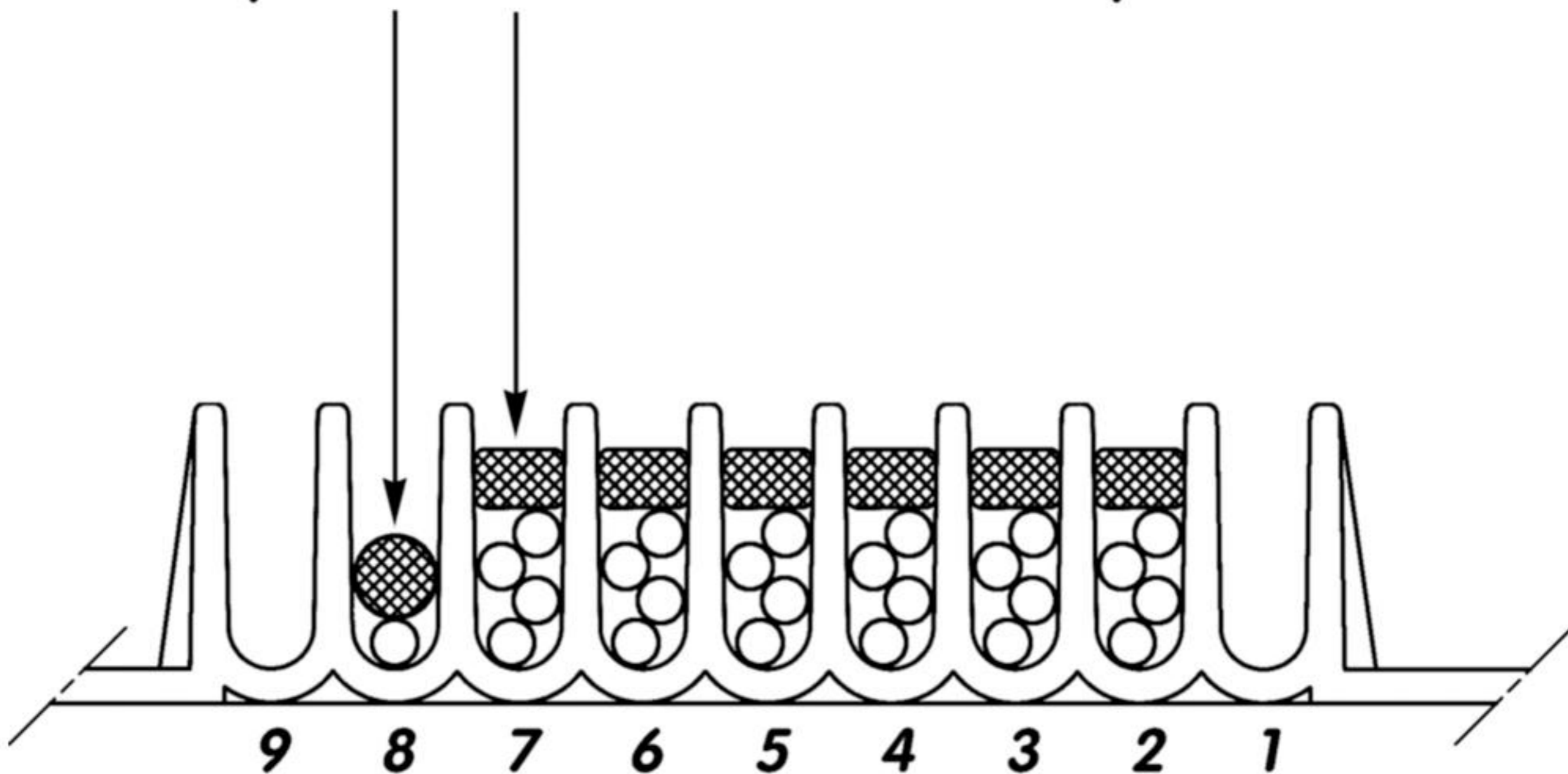

Kasetinpidin

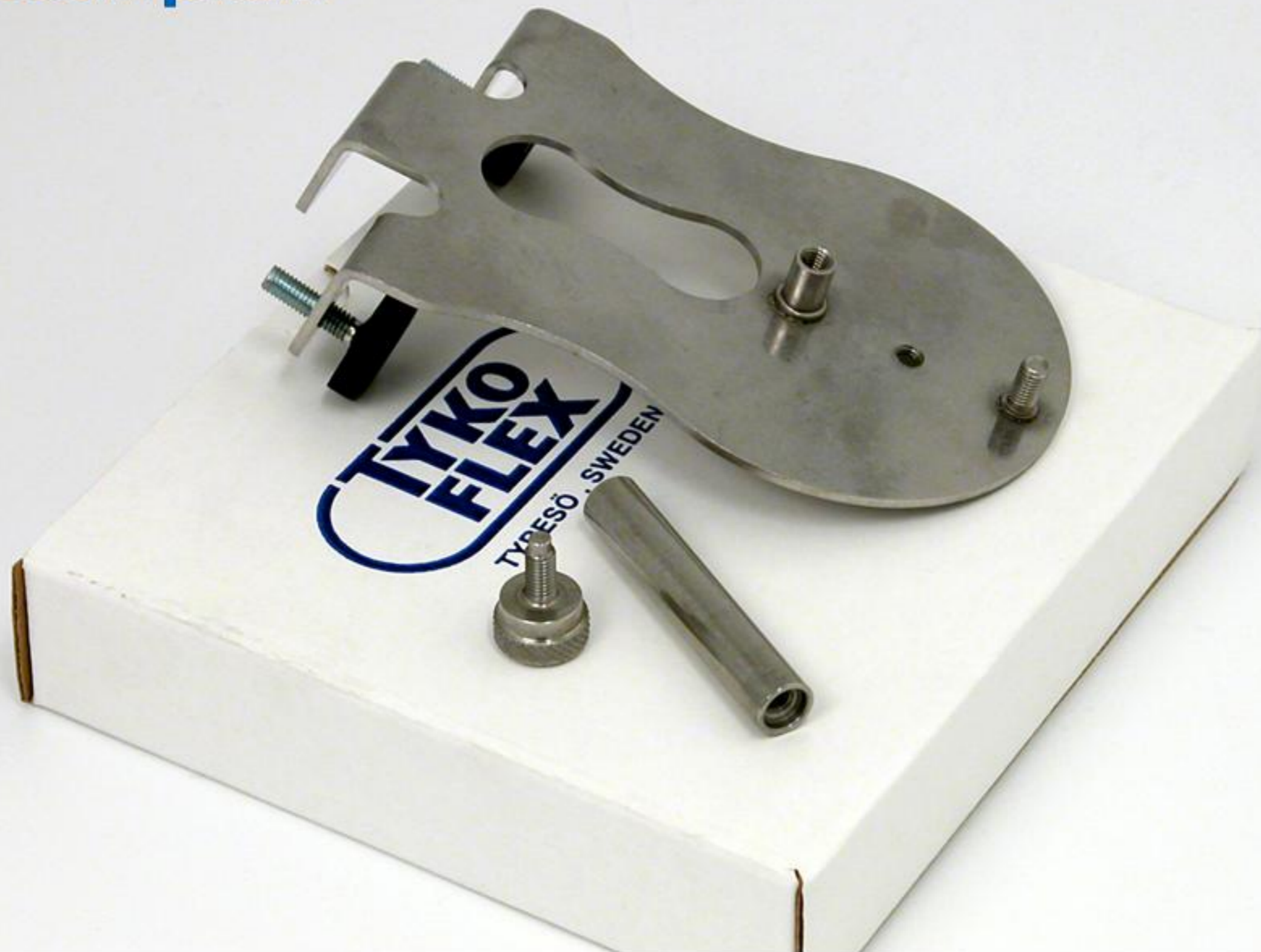

Kasetti-pitimen käyttö



*Kasetti
työasennossa*

*Kasetti
selailuasennossa*

Jatkoskotelotyökalut

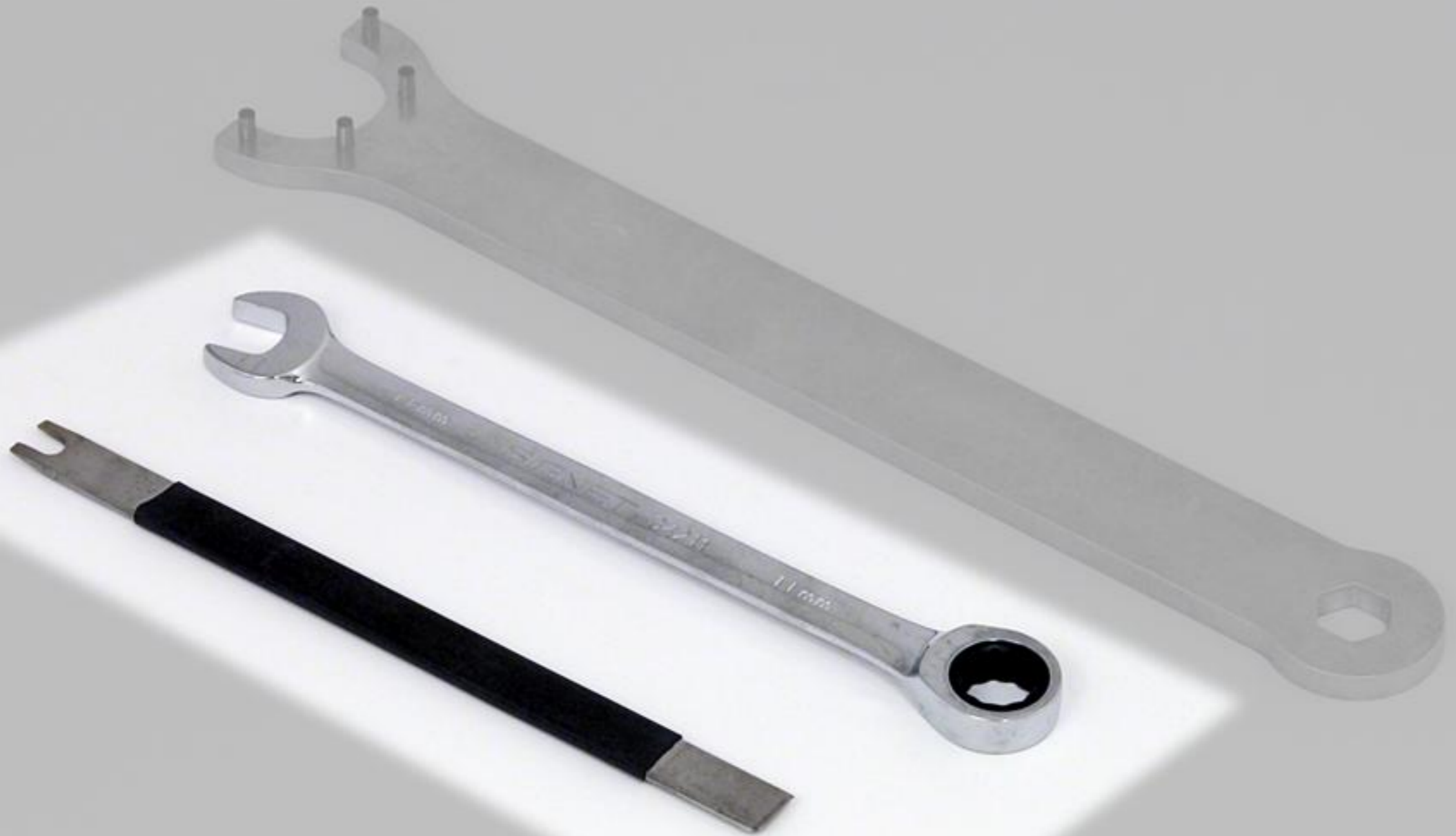



Suosittelavat Spiral-Space -kaapelin kuorintamitat

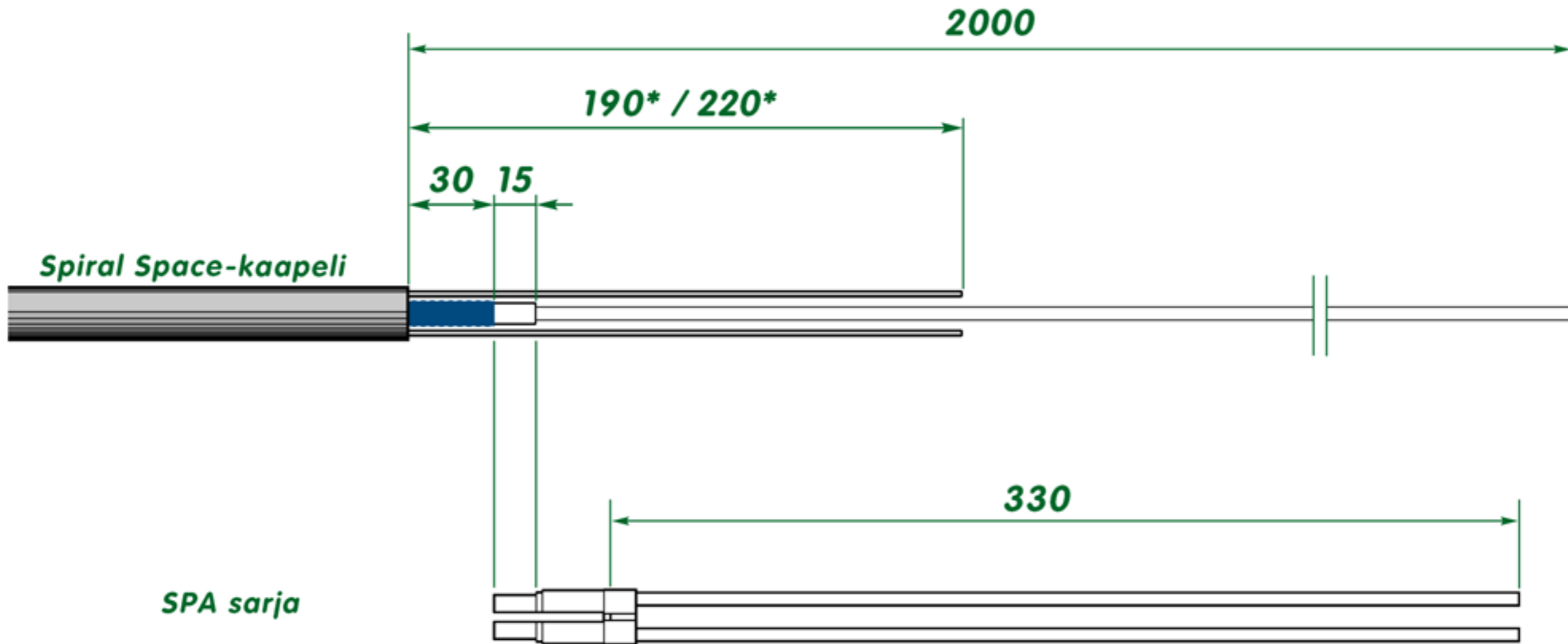

**) Alarivin läpiviennit = 190 mm
Ylärivin läpiviennit = 220 mm*

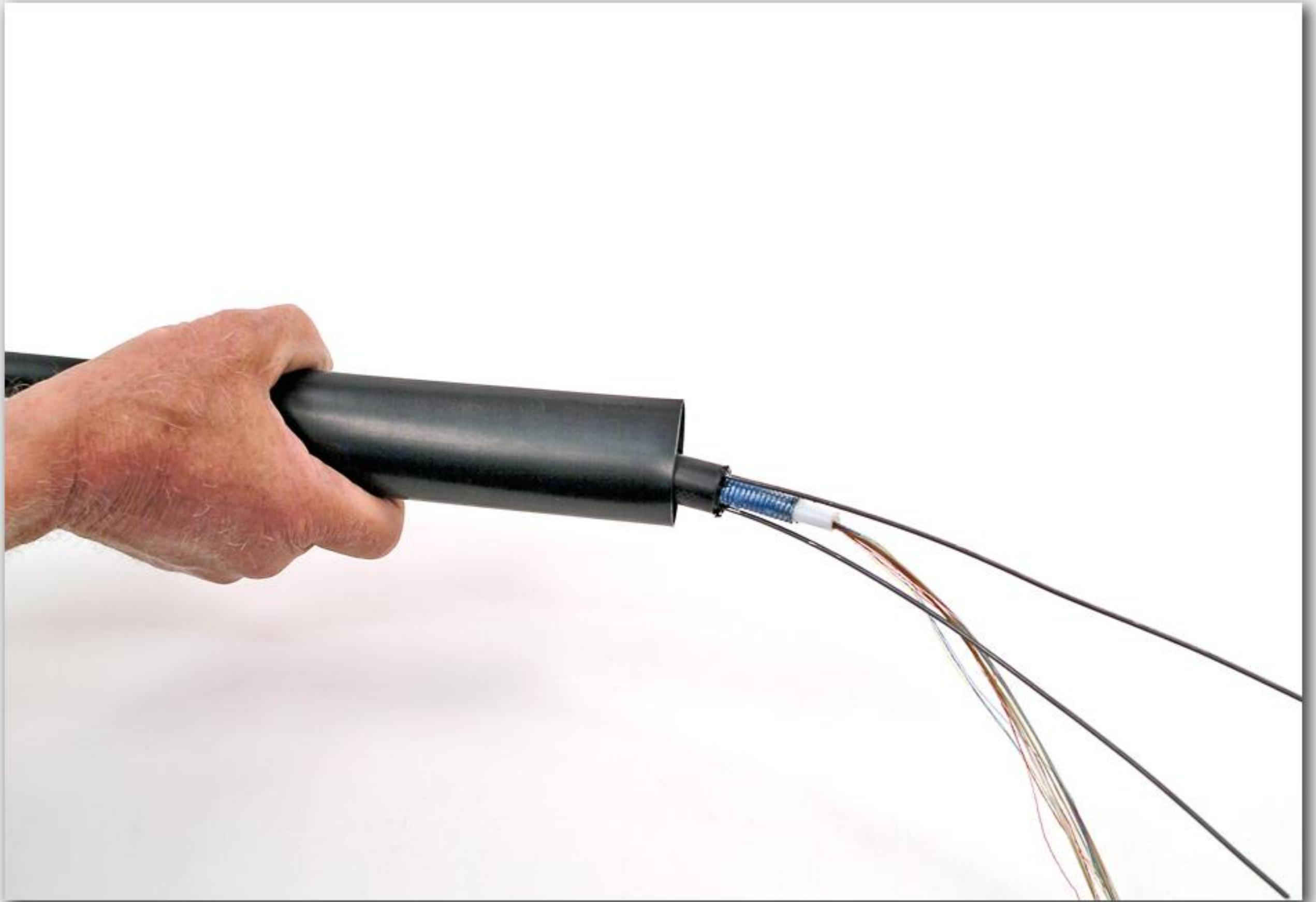

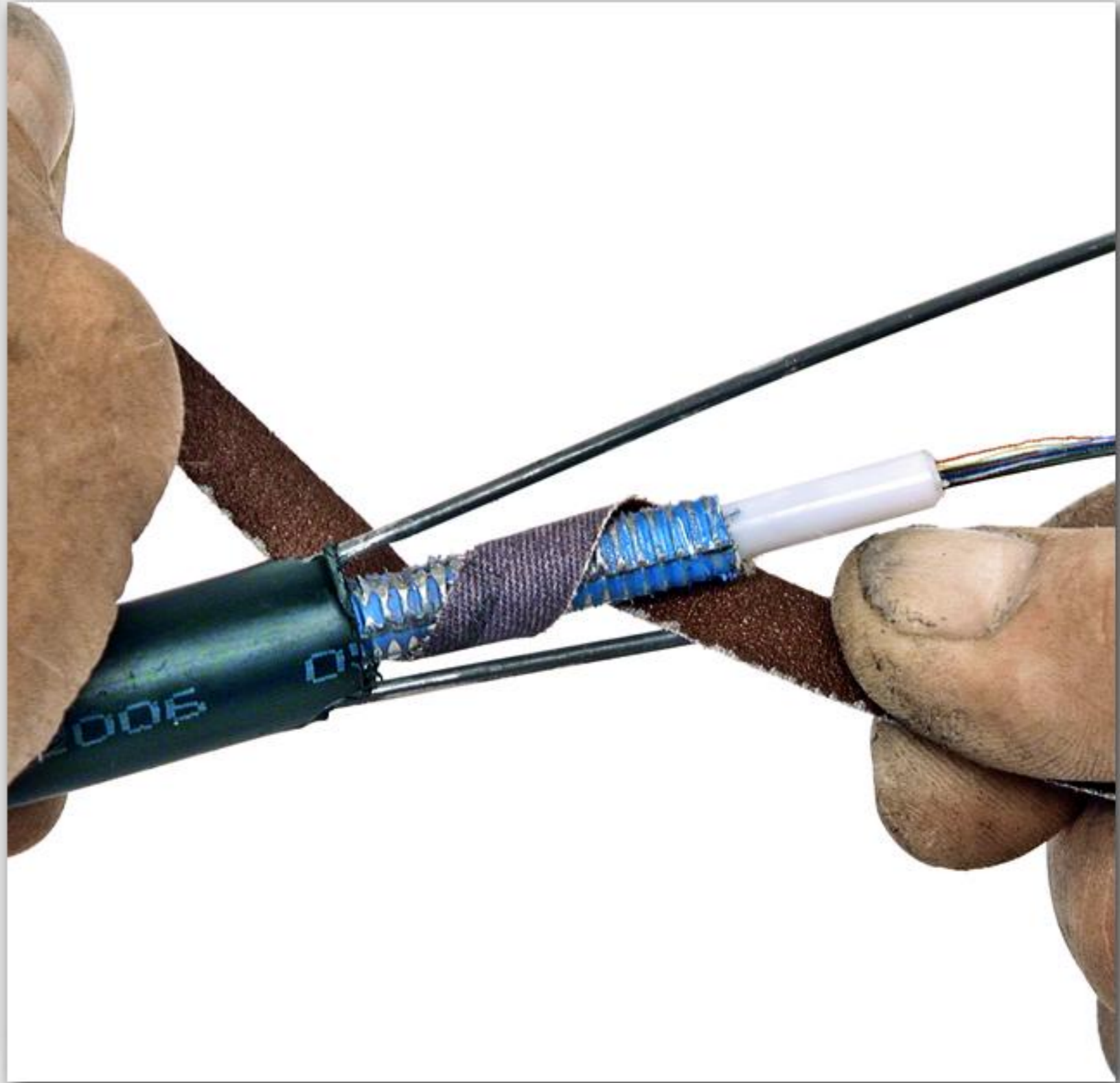



"9 OET"
6, 12 ja 24 -kuidun kaapelille

"11 OET"
48 ja 96 -kuidun kaapelille



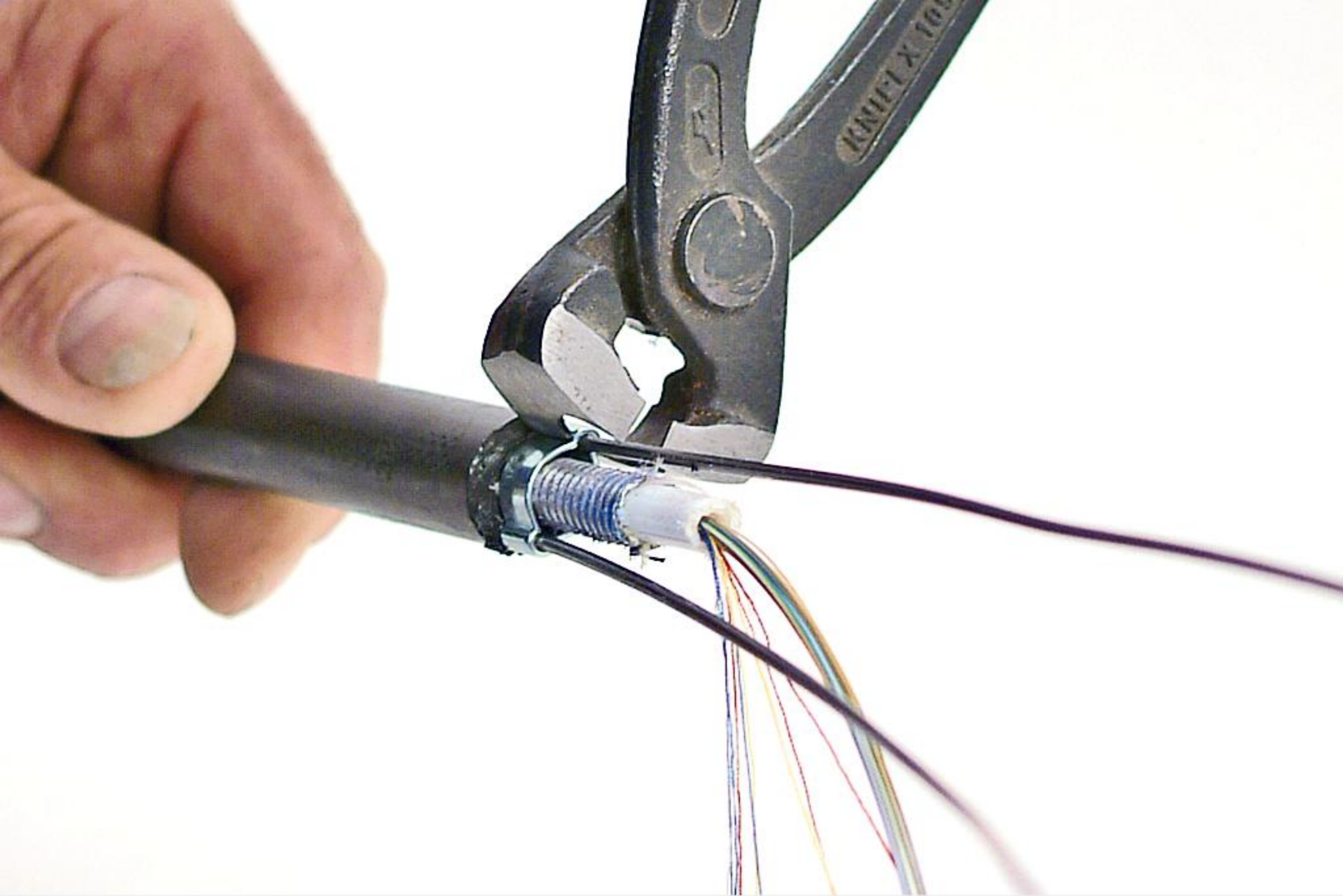

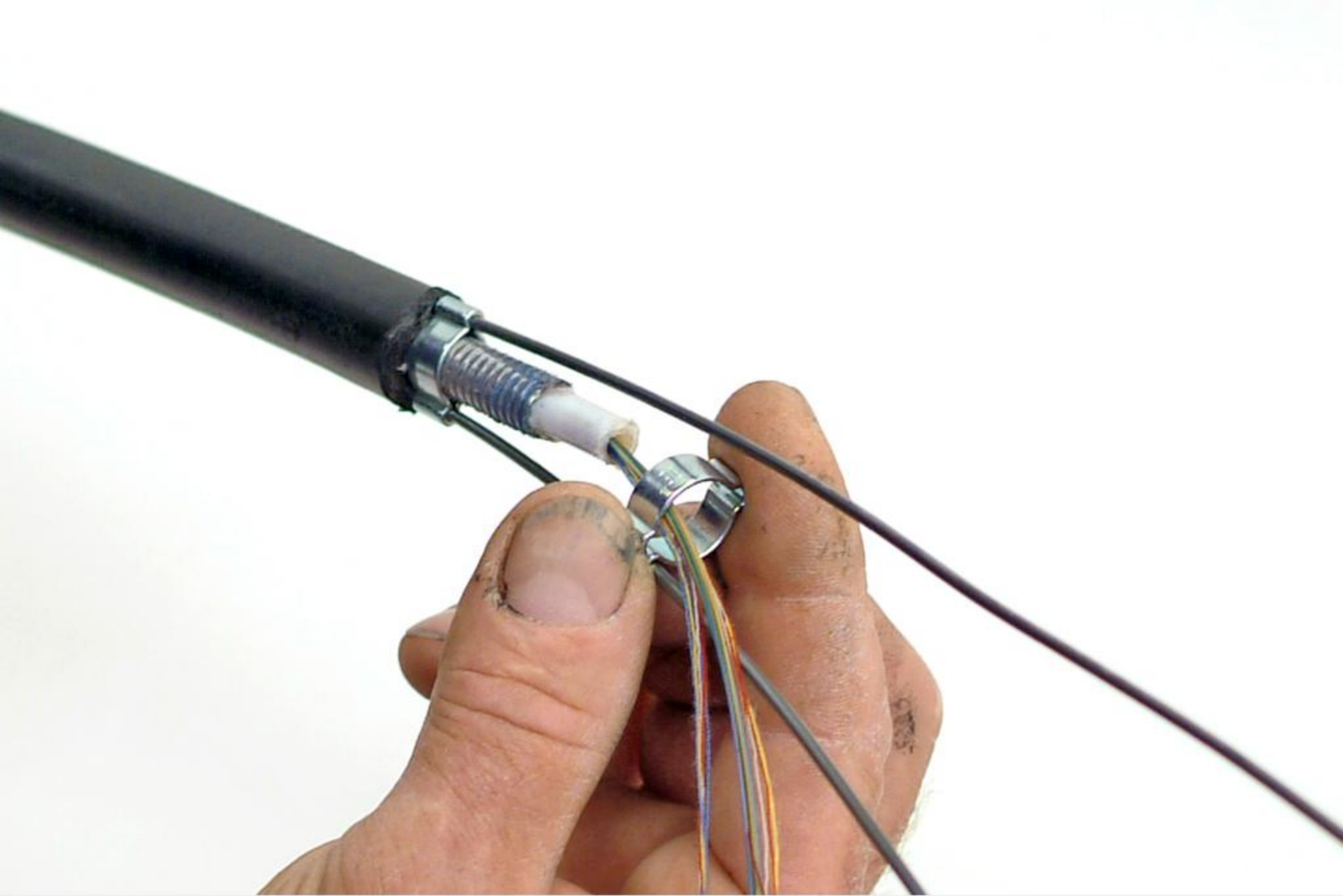

"11 OET" 6, 12 ja 24 -kuidun kaapelille
"13 OET" 48 ja 96 -kuidun kaapelille

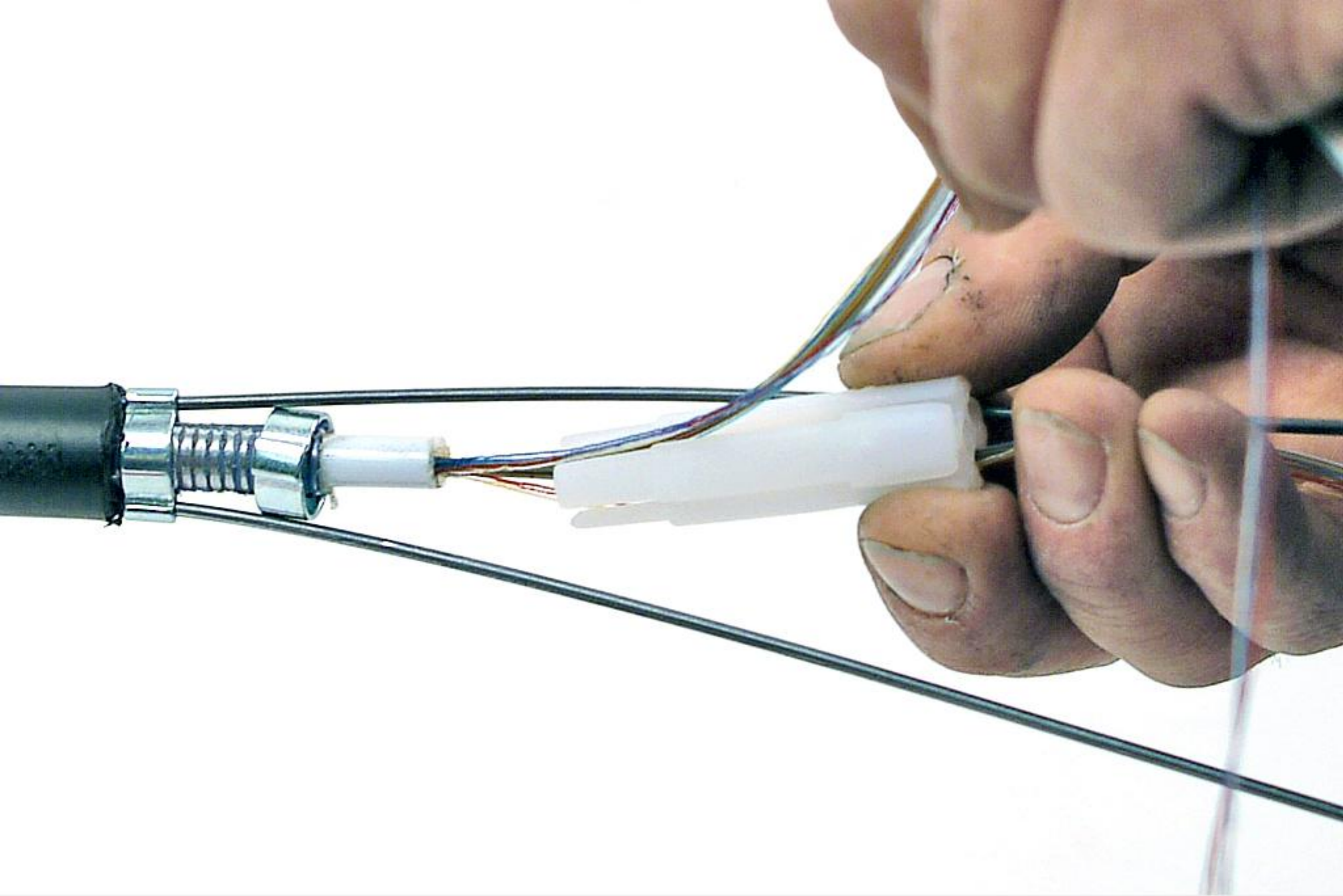

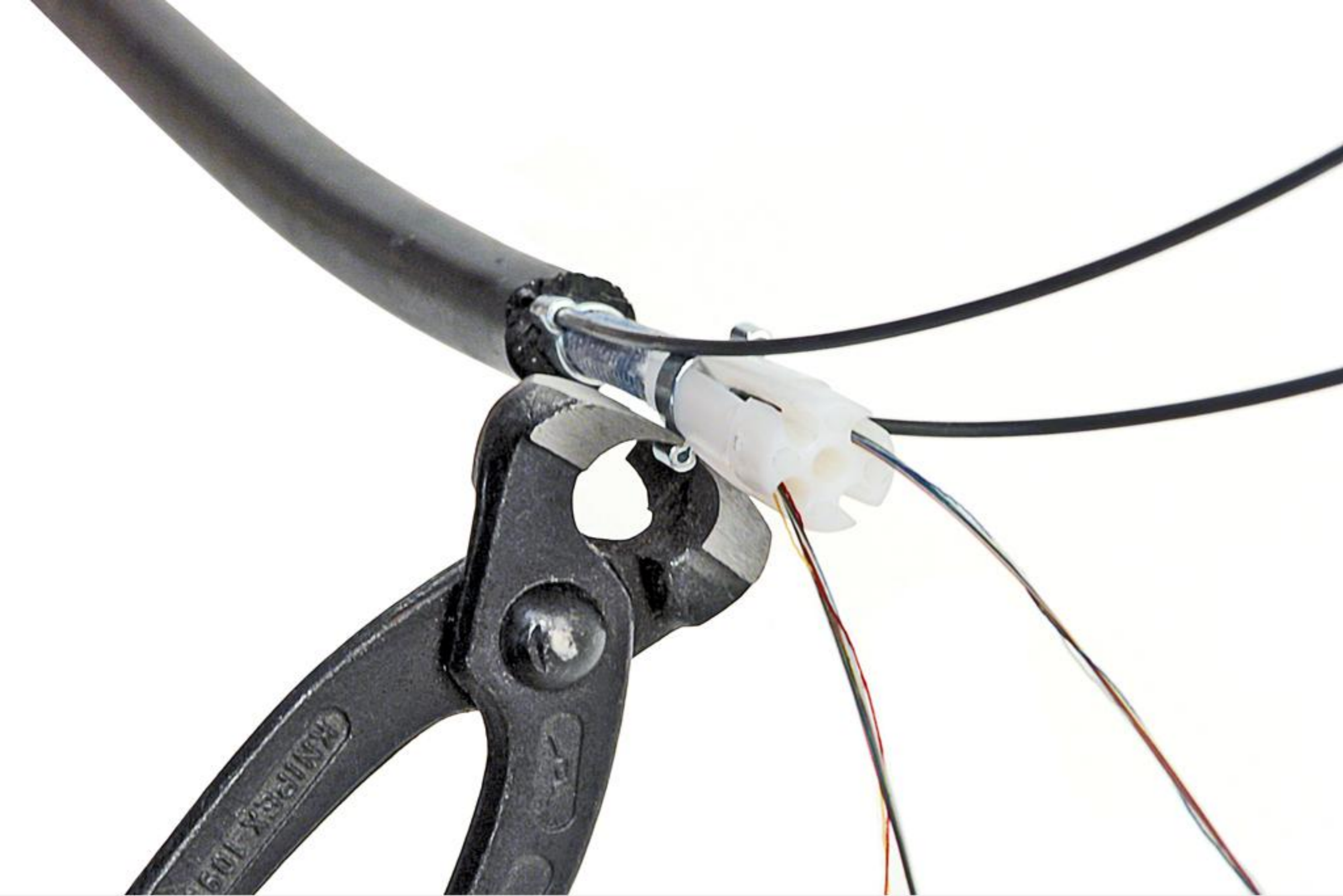

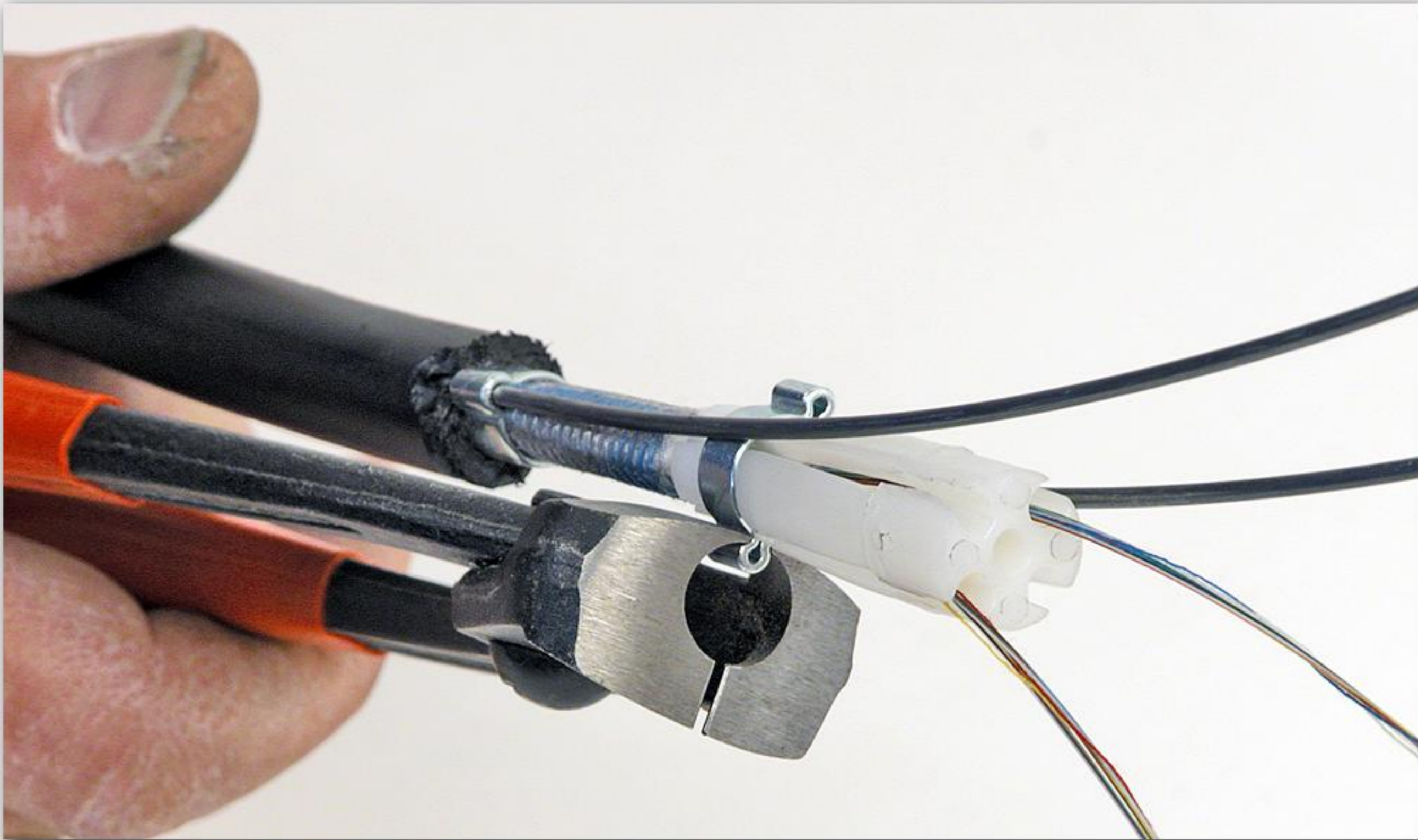

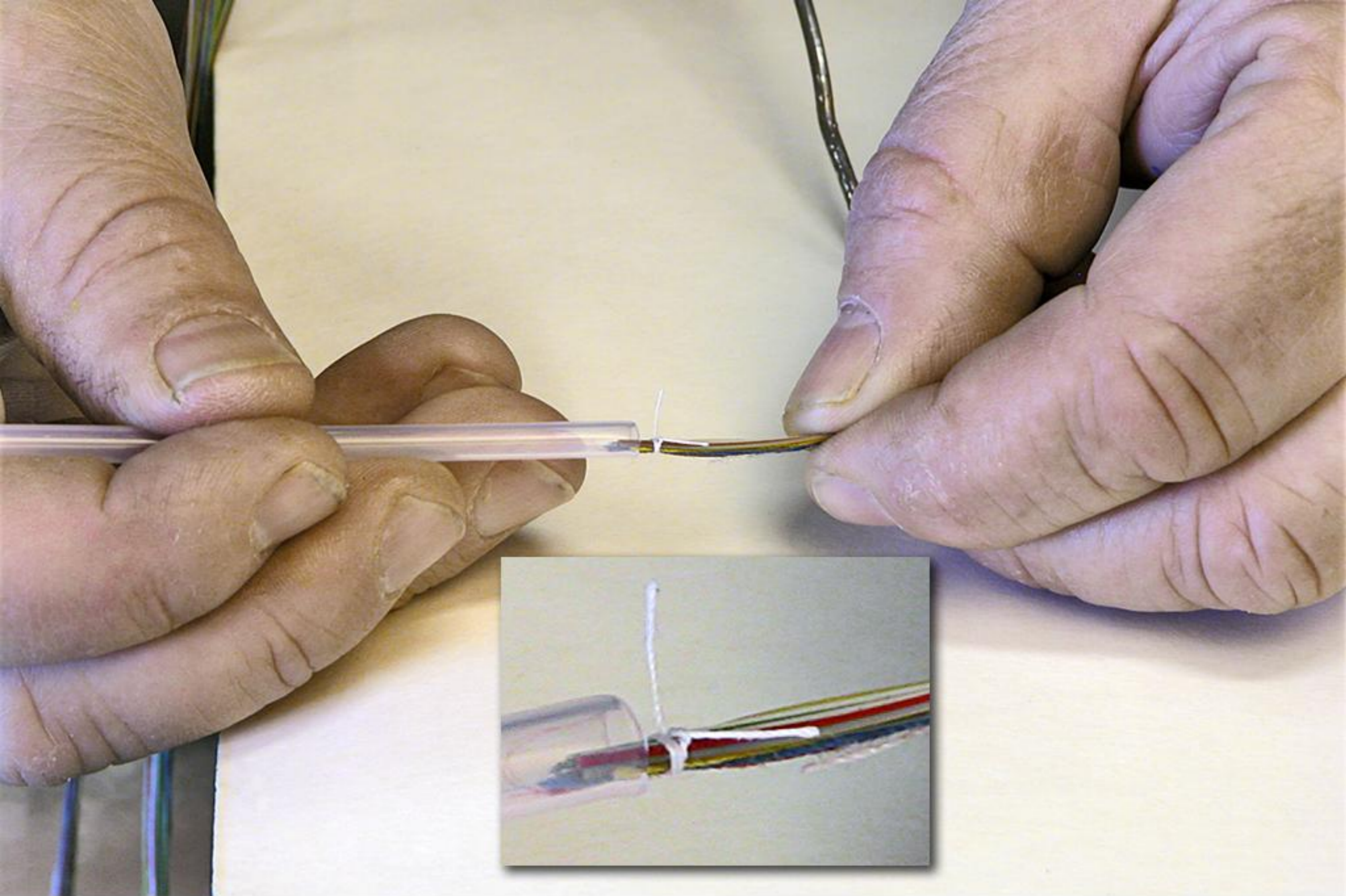

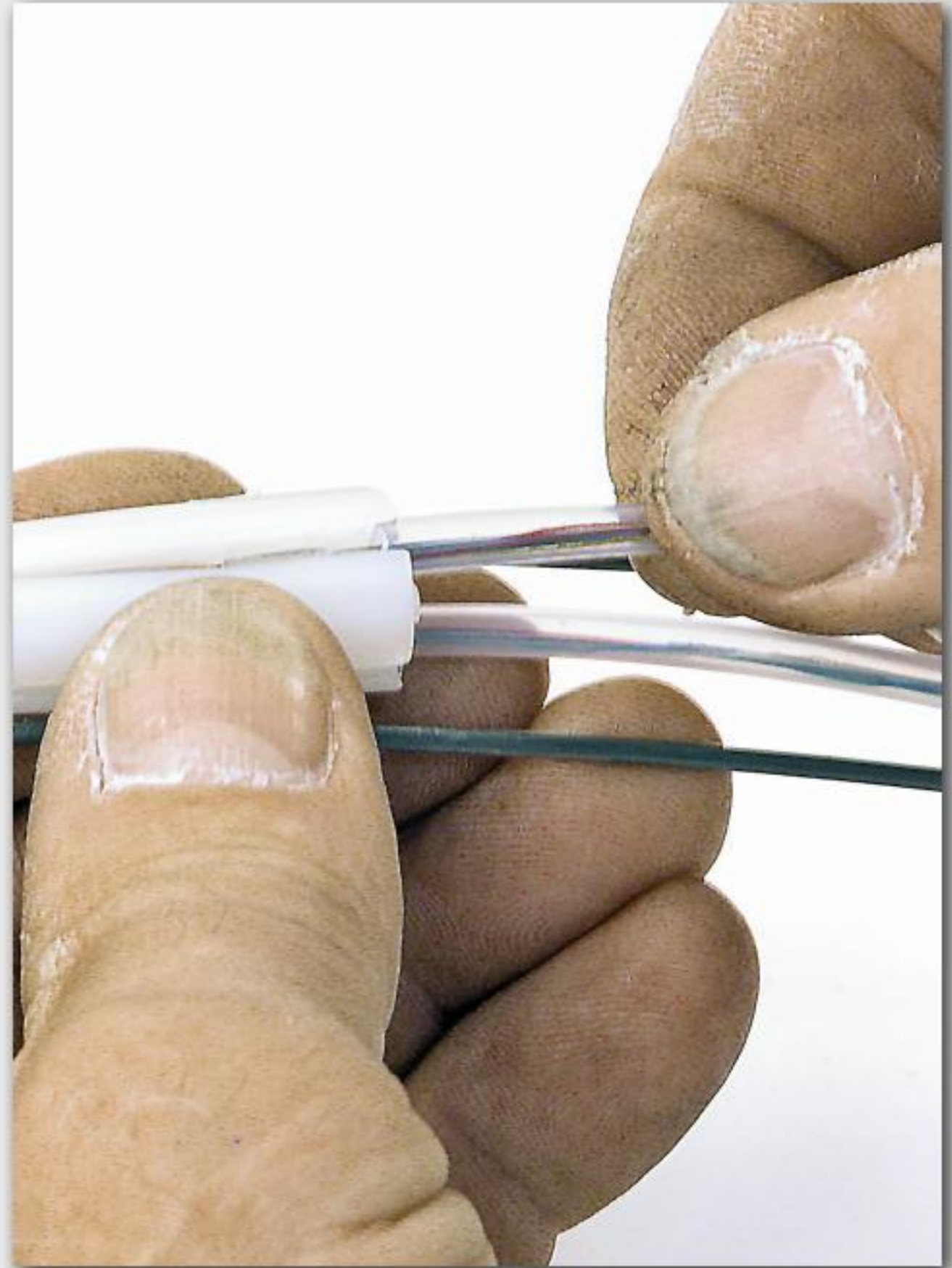

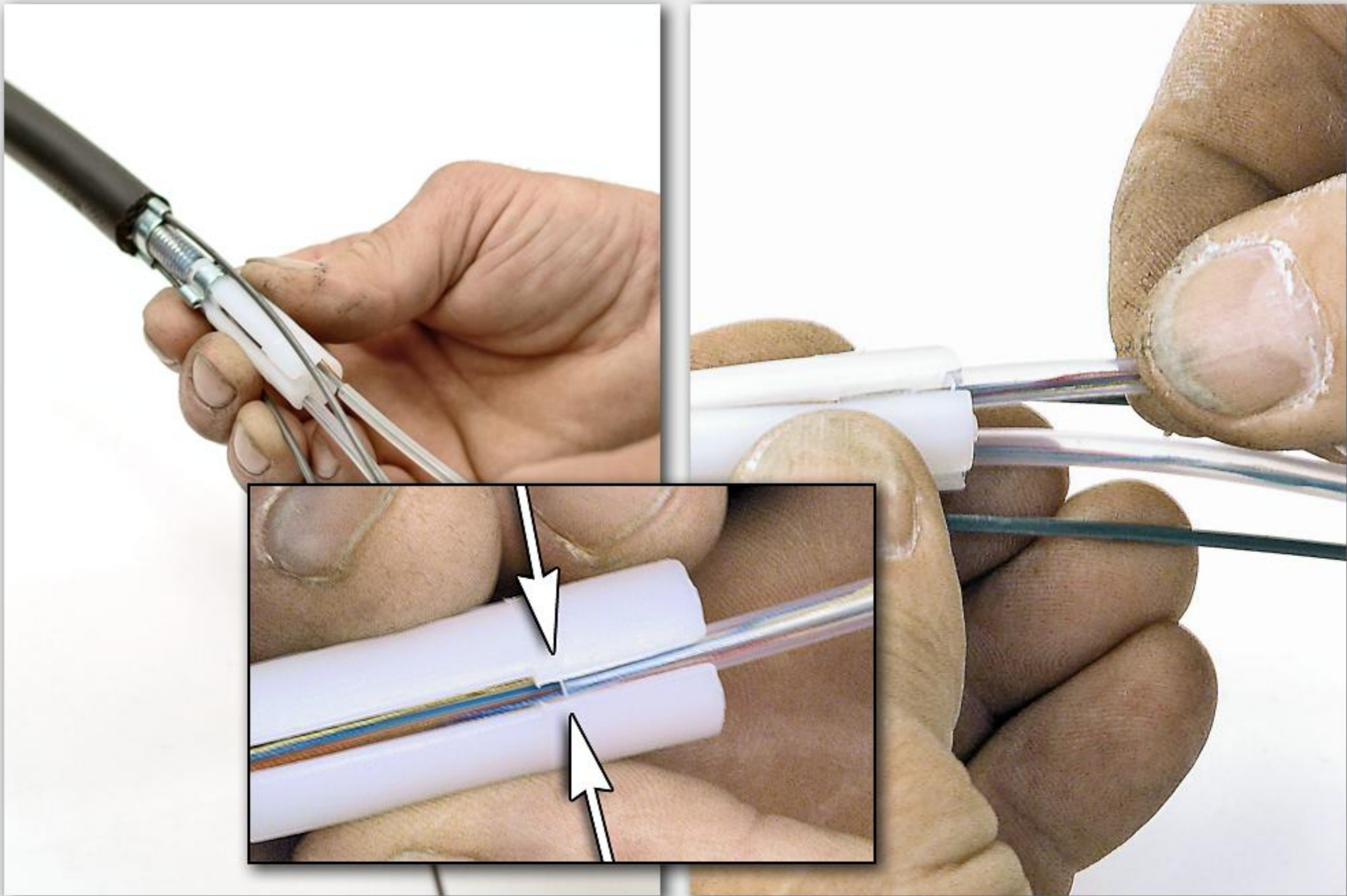



Ylärivin kaapelit = 181 mm
Alarivin kaapelit = 209 mm





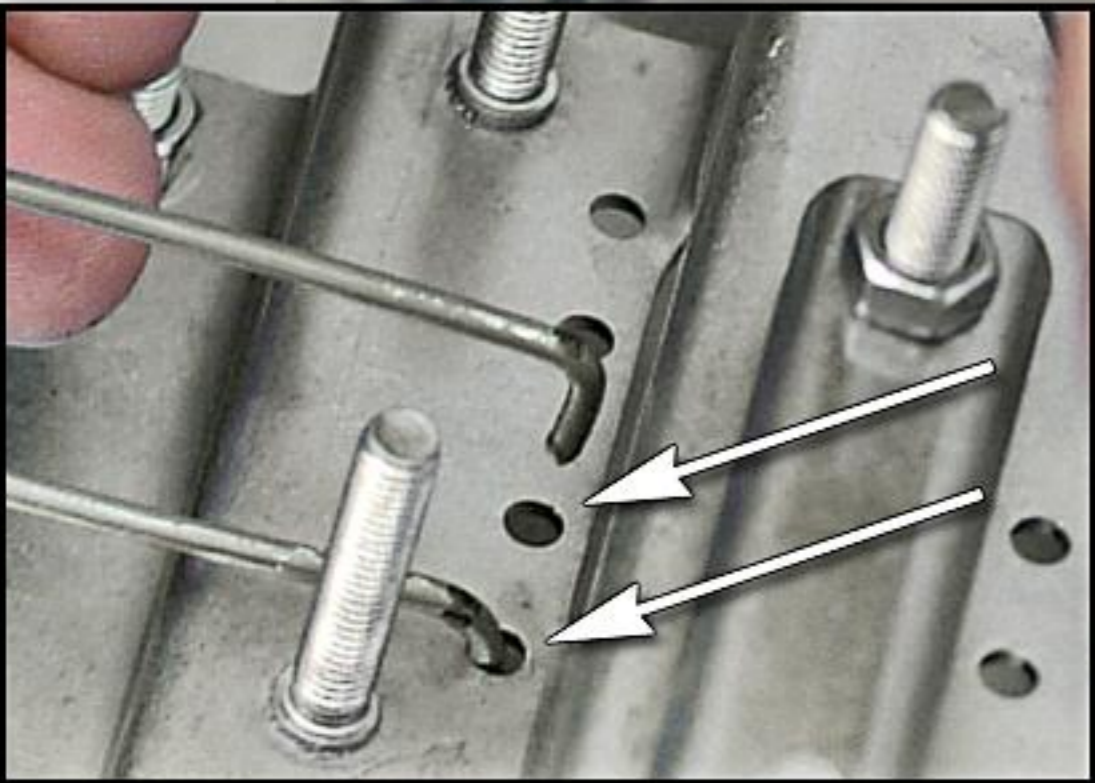





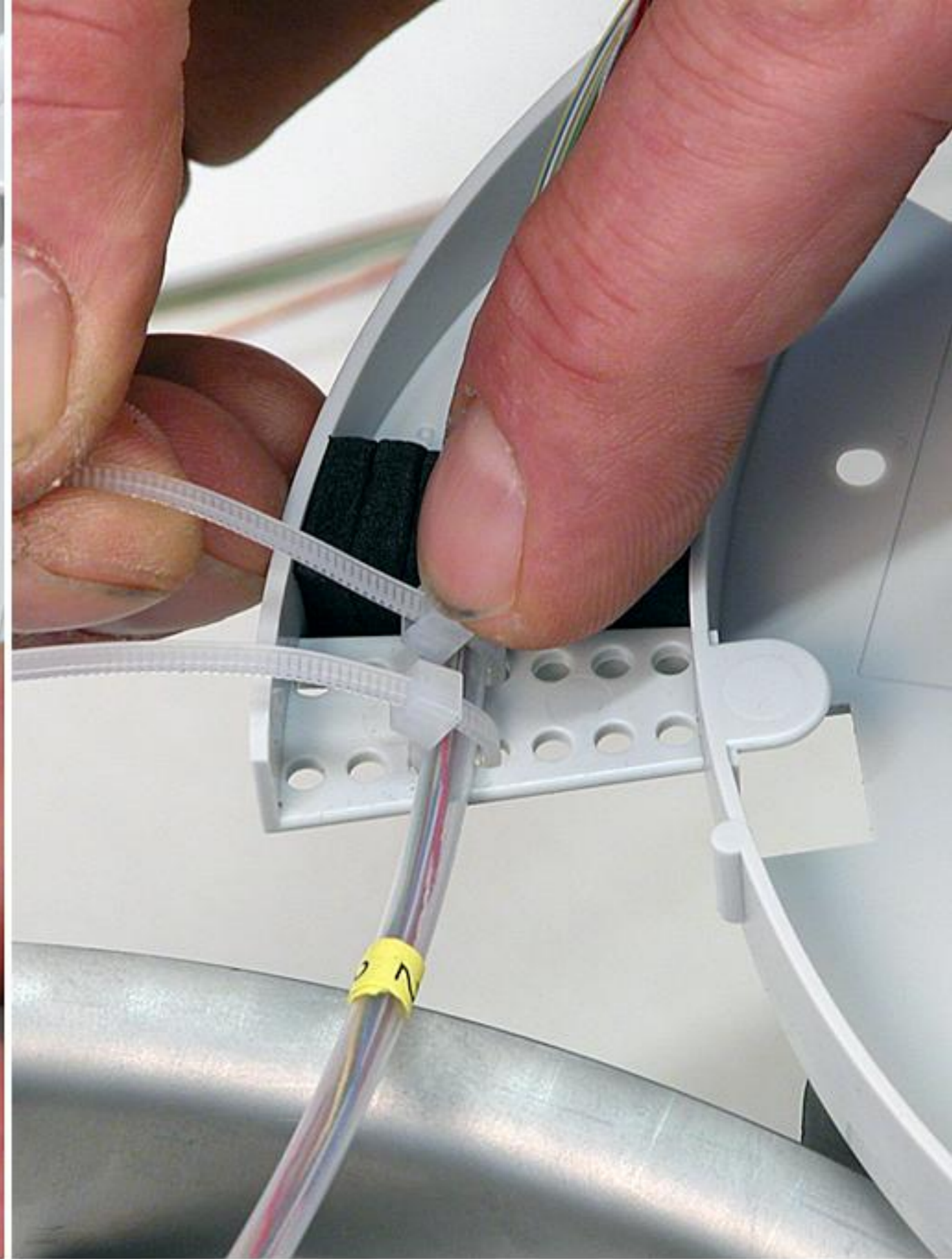
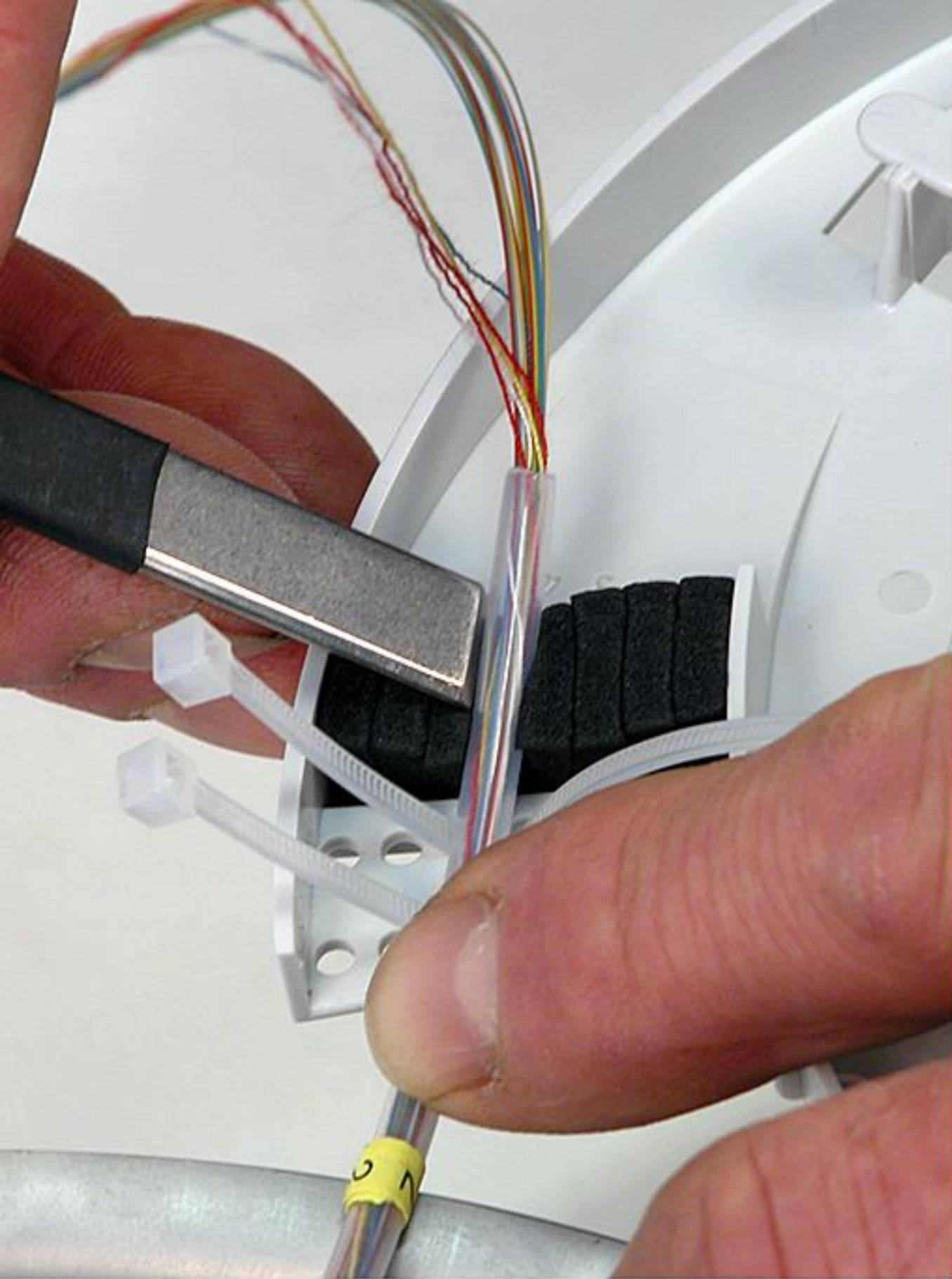

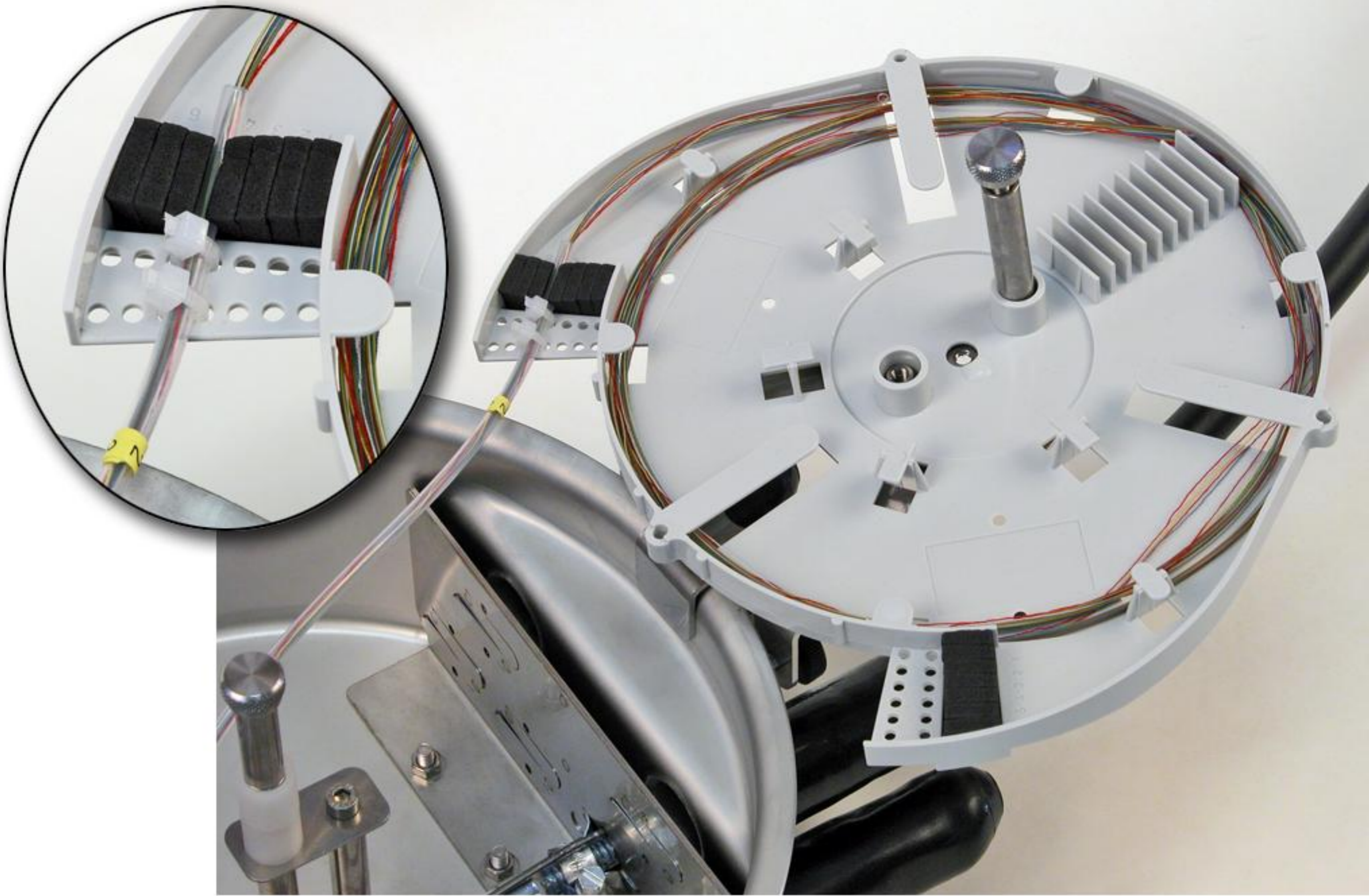

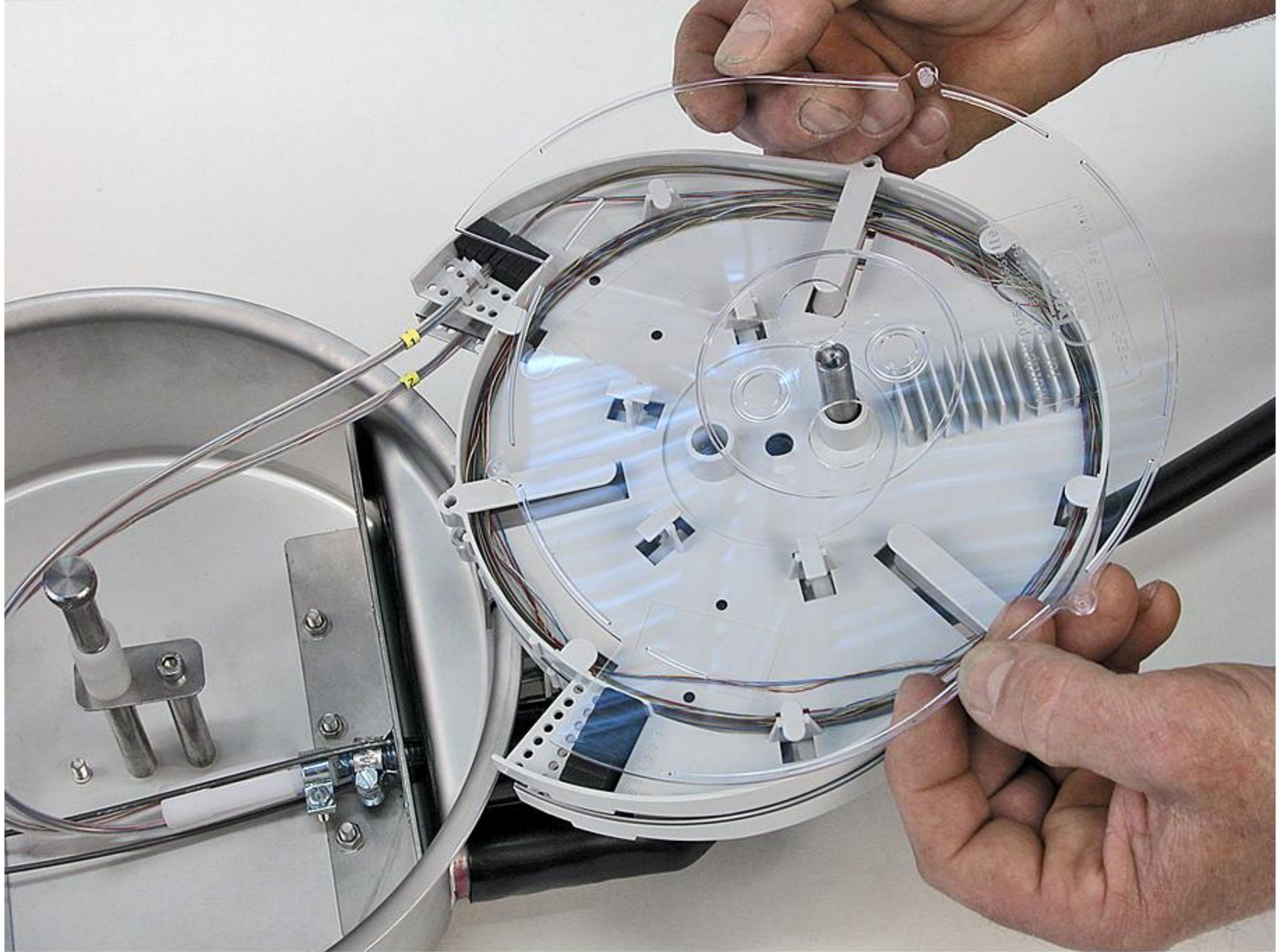

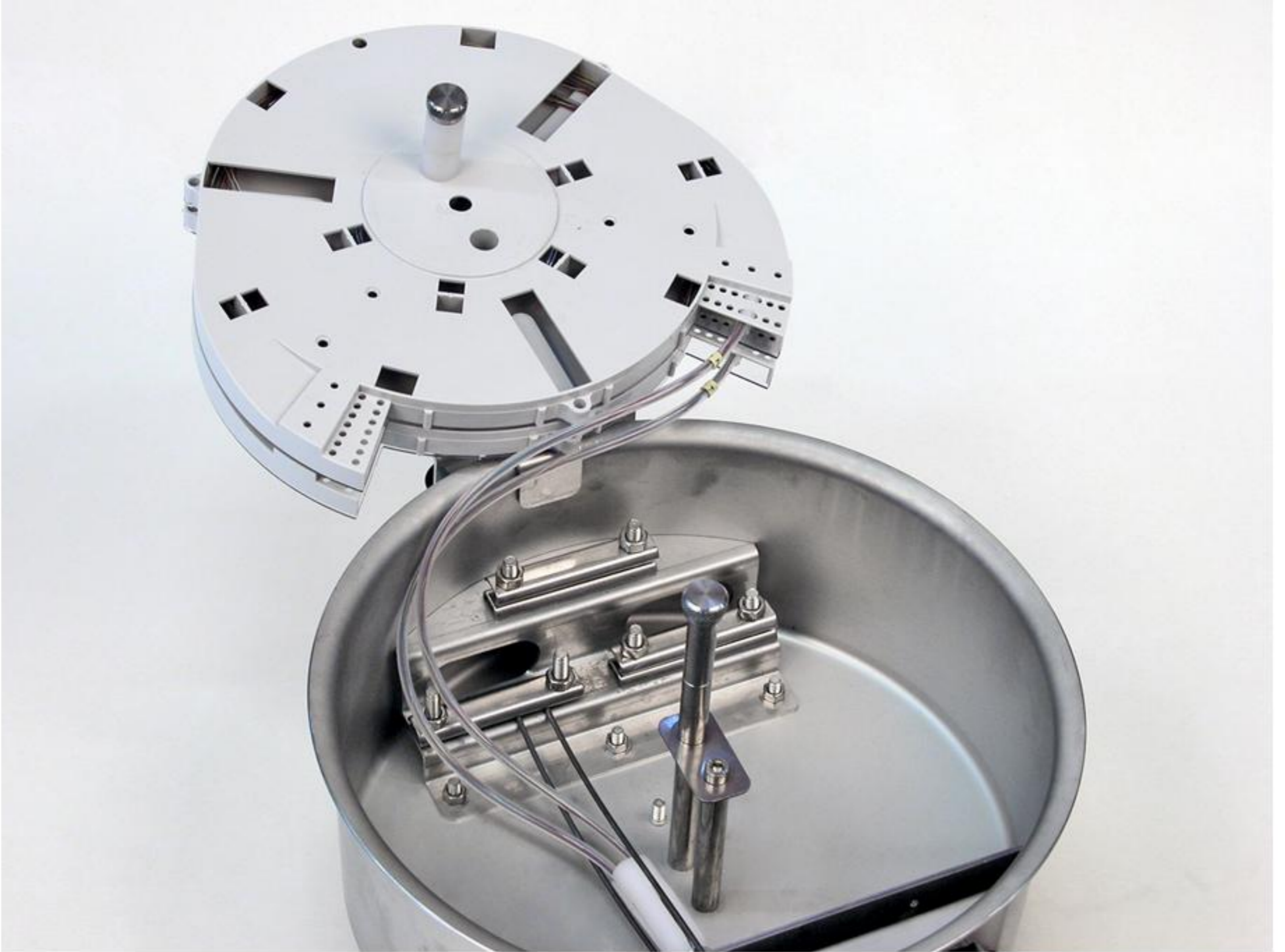

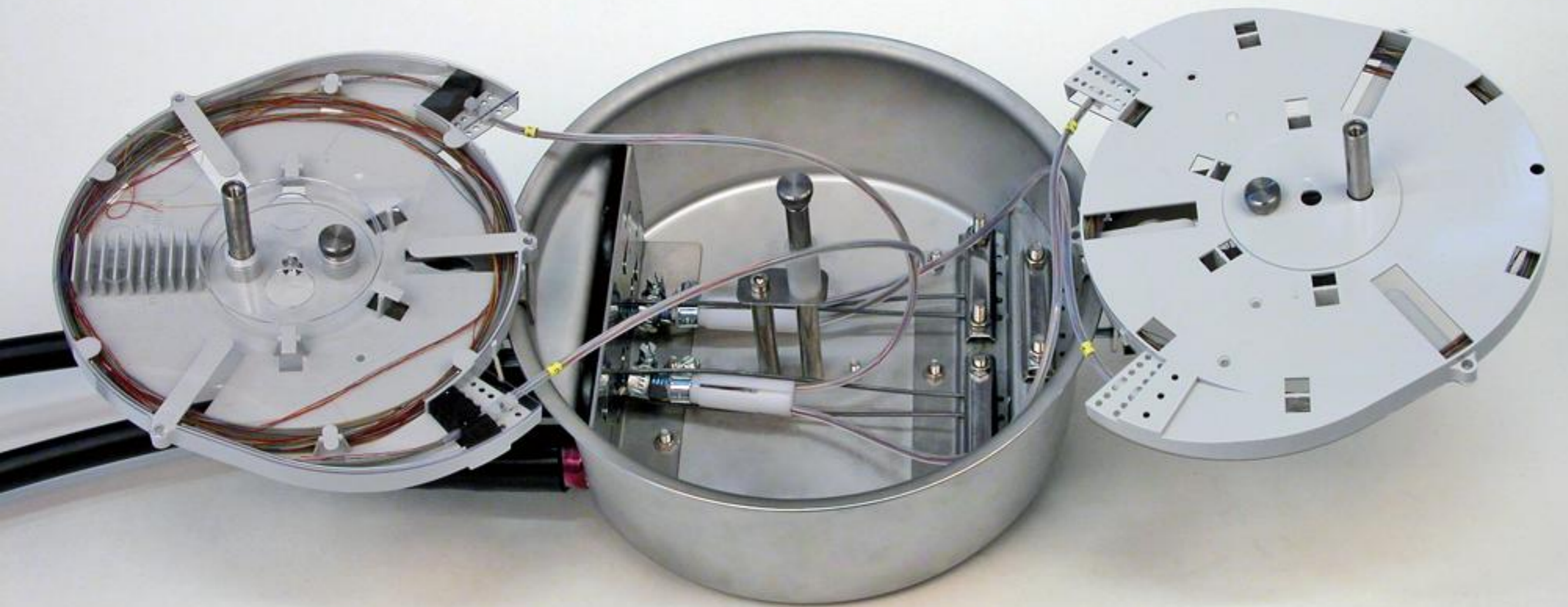

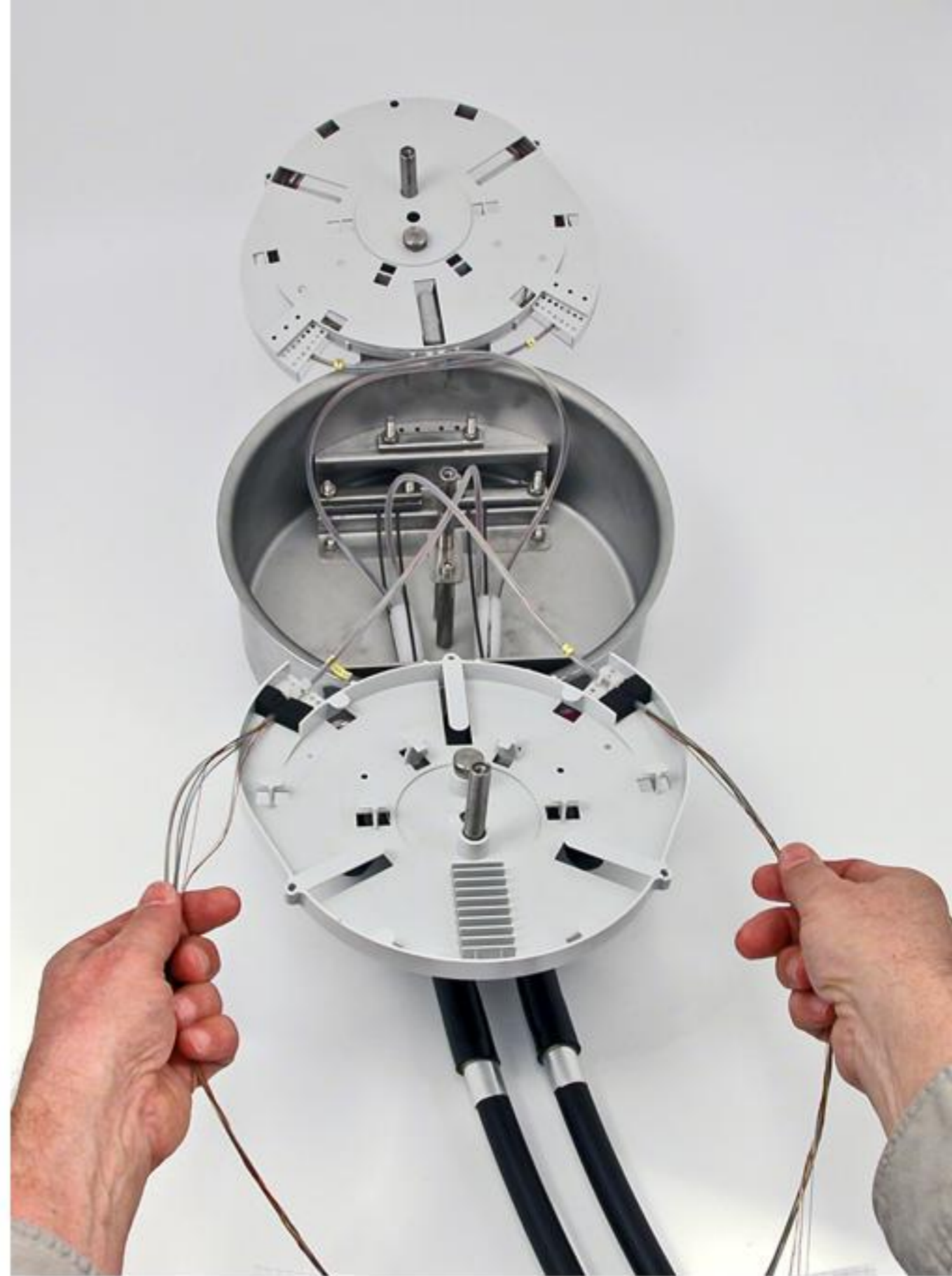
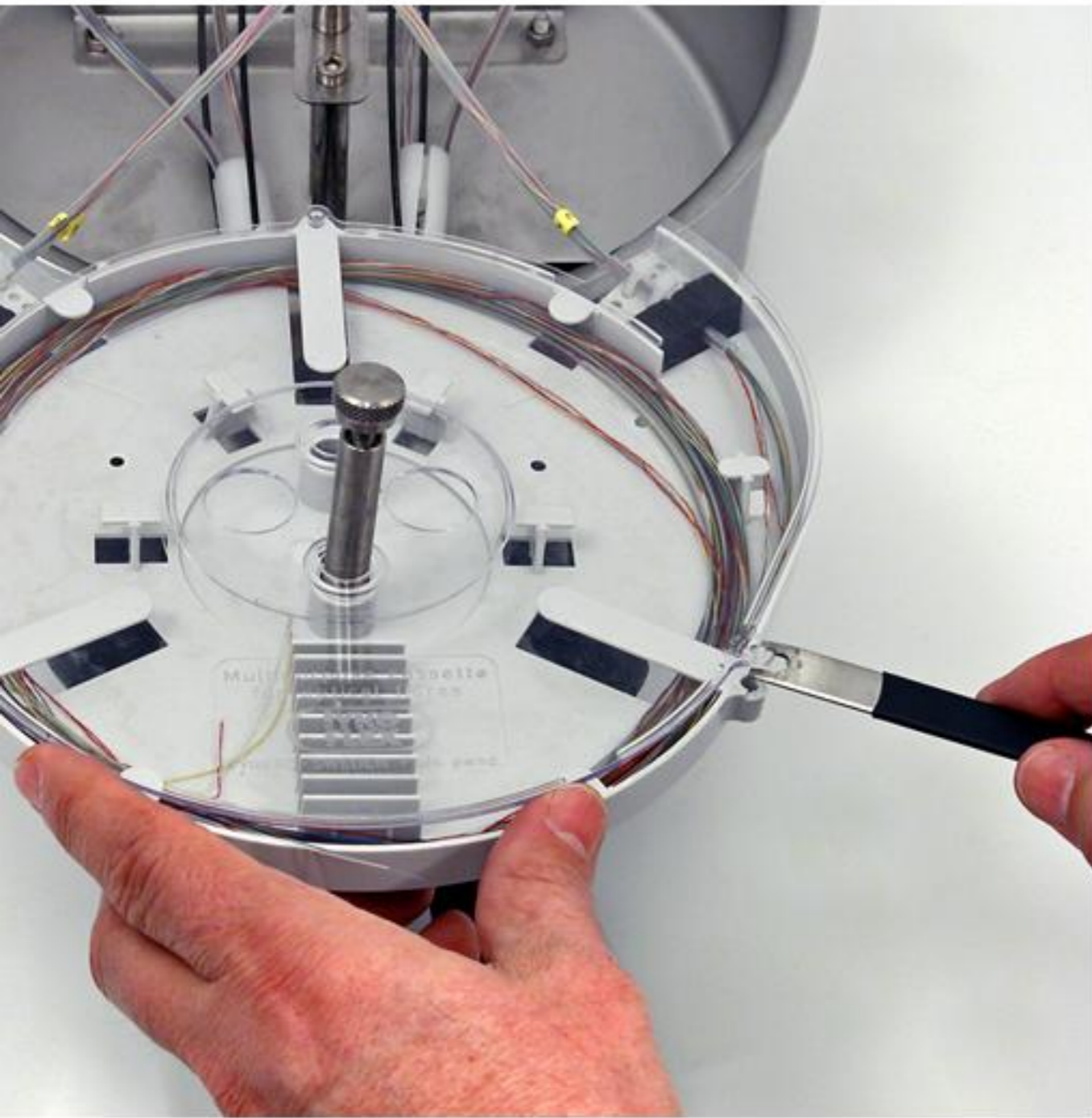



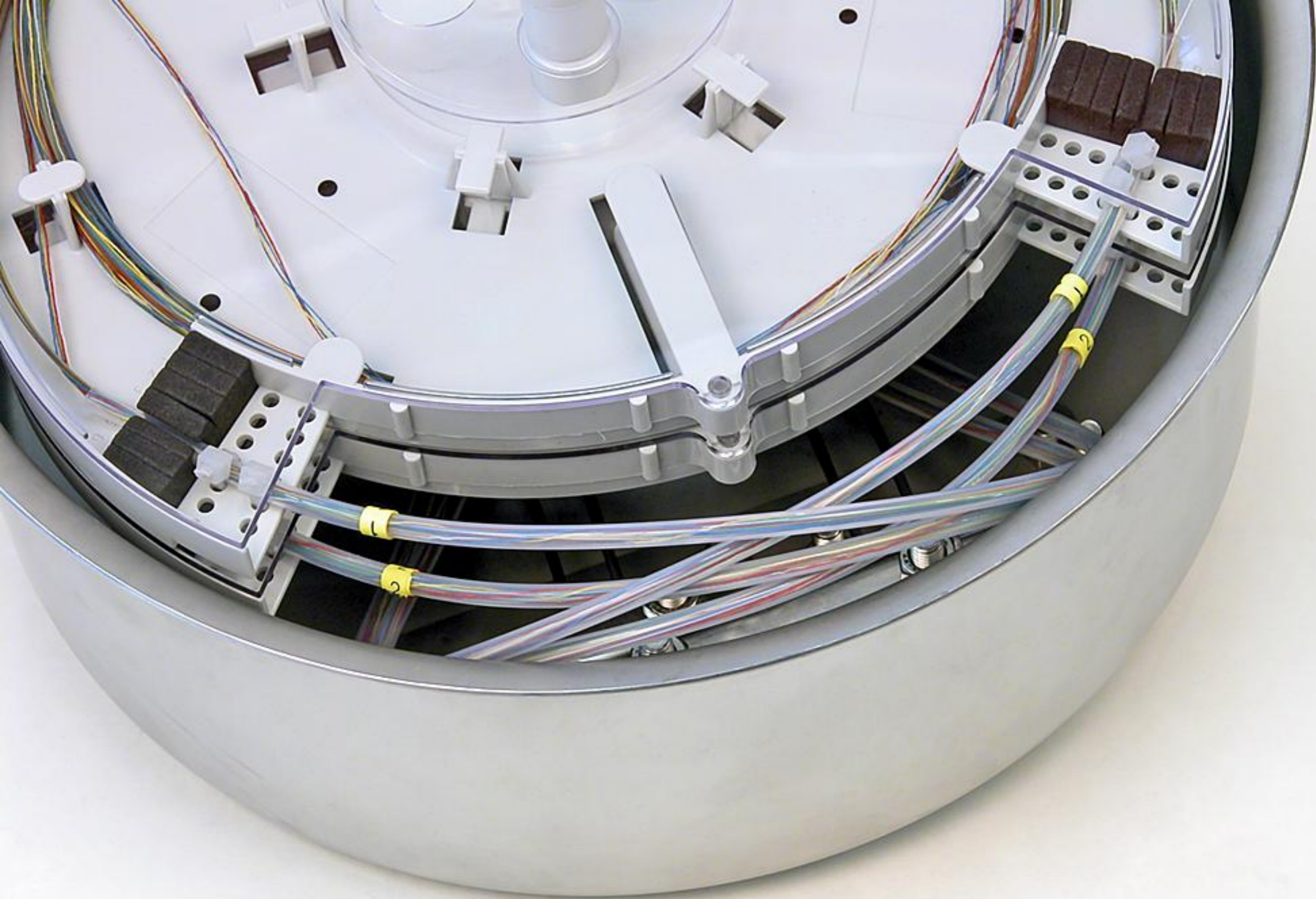

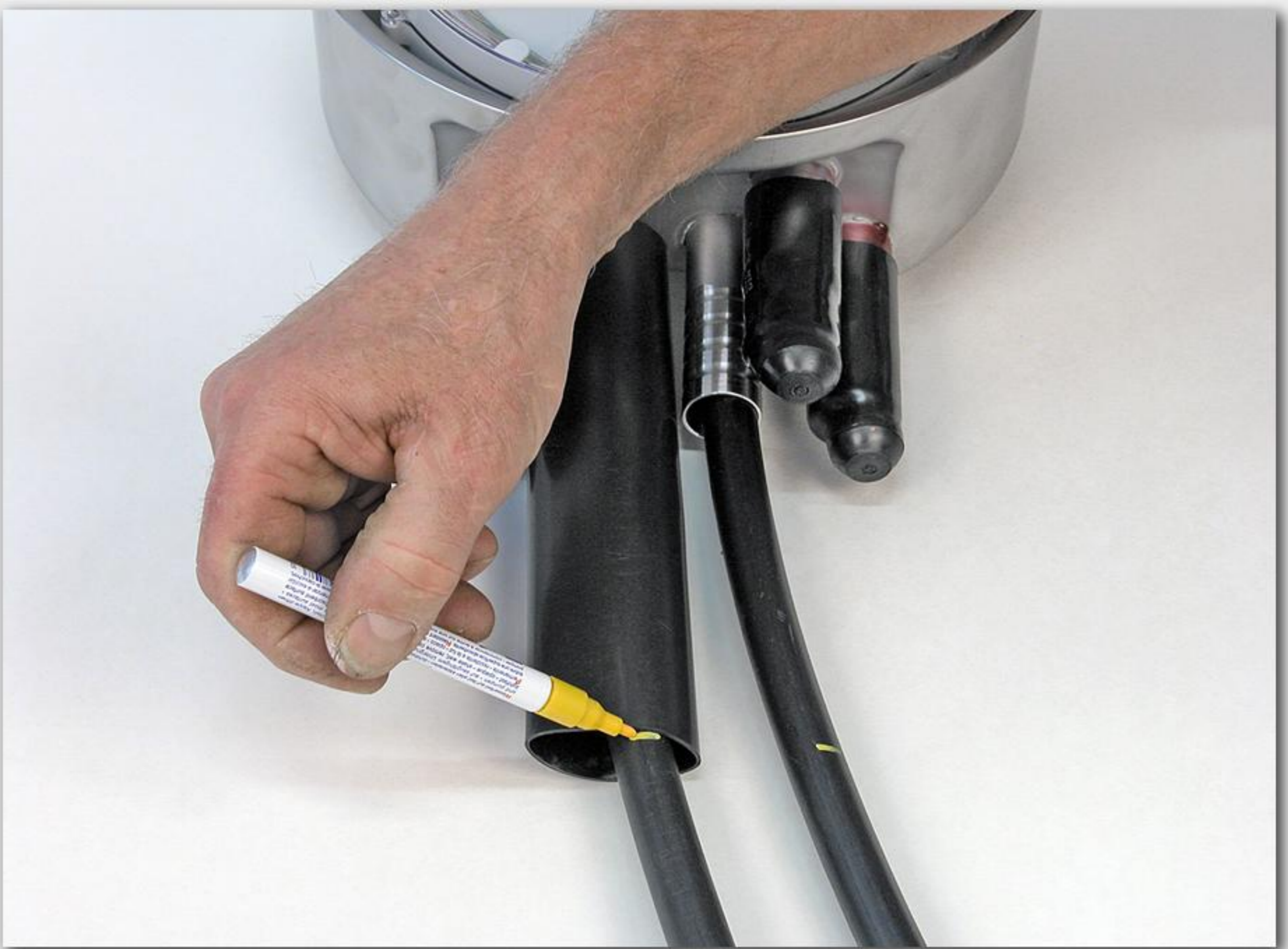

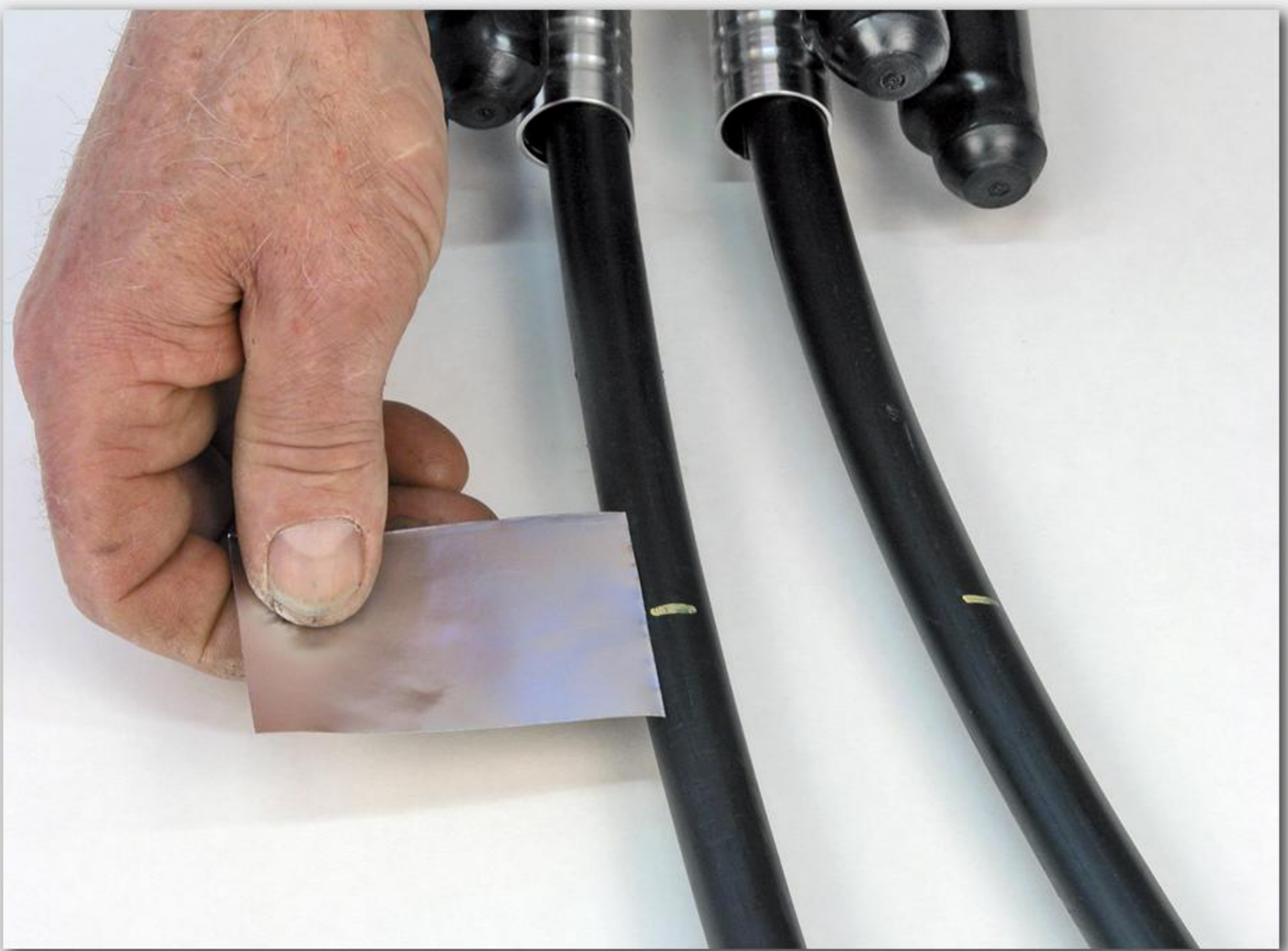

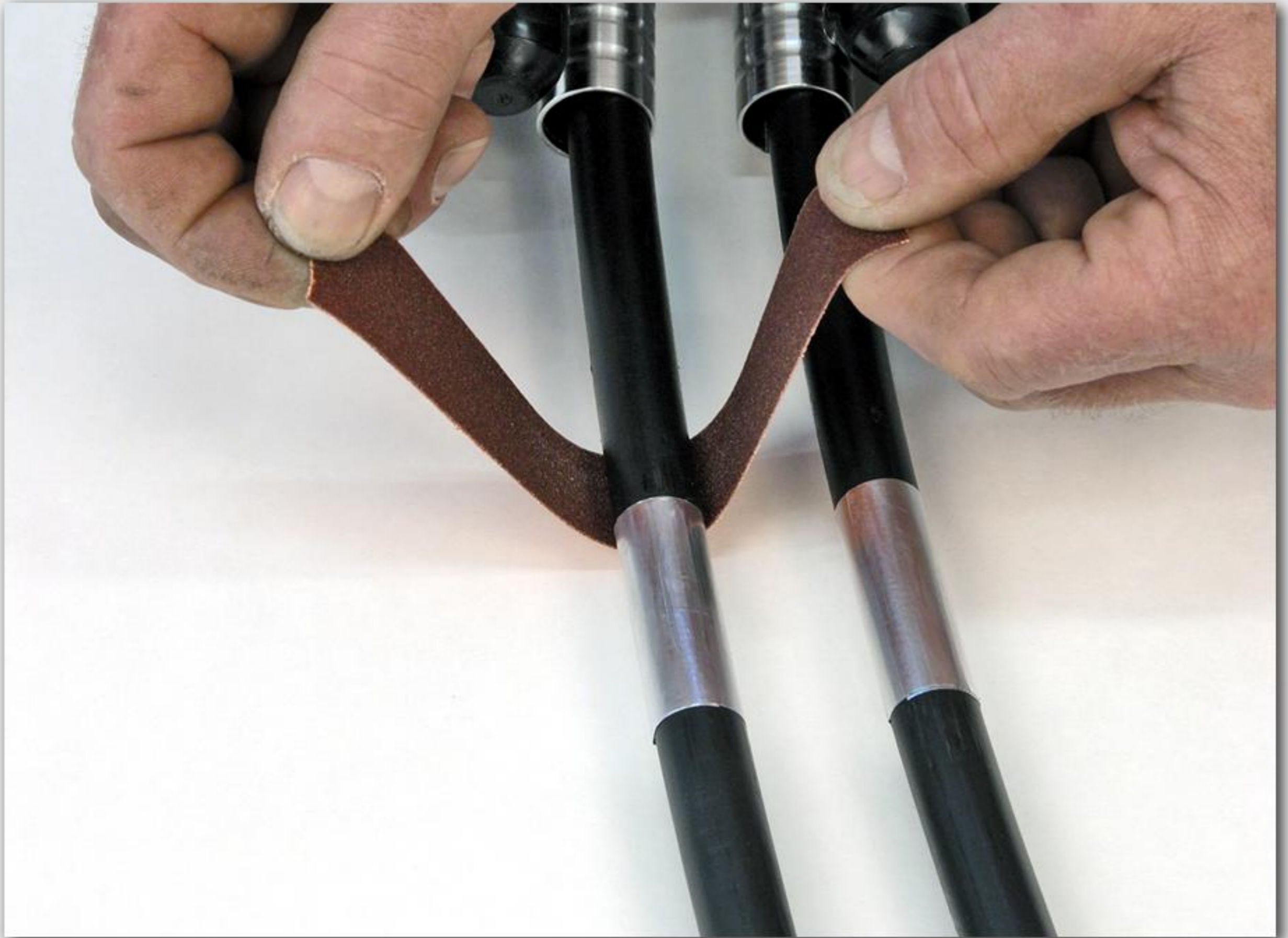





Aloita tästä







