

# SPINNER Mobile Communication



## Site and In-Building Portfolio



HIGH FREQUENCY PERFORMANCE WORLDWIDE  
[www.spinner-group.com](http://www.spinner-group.com)



## Designation of Mobile Communication Products

Most of our products such as connectors, adaptors and jumpers can be used for all common mobile communication frequencies. Other products support dedicated bands only. To help you make the right choices we have decided to introduce icons for specific bands:



This product is suitable for PMR/TETRA (Private Mobile Radio/Terrestrial Trunked Radio).



This product is suitable for GSM-R.

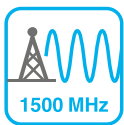

This product is suitable for the L-Band.



This product can be used for up to 3800 MHz.

Some of our products will be customized before being dispatched. The products for which this service is available are designated in our catalogue by the logo shown below:



Used for products that are specially customized before being supplied.



For more information on products, please use our Product Finder at [products.spinner-group.com](https://products.spinner-group.com)



You can get the latest new edition of our mobile communications catalogue in the download section of our website. Please follow this link: [www.spinner-group.com/downloads](https://www.spinner-group.com/downloads)

The specifications given here as well as the illustrations are for information. They shall only be confirmed by SPINNER's written offer and are subject to technical amendments.



## Contents

SPINNER Sets Standards in RF Technology.....	4
Passive Intermodulation – PIM.....	6
Connectors.....	7
Connectors – Type 7-16.....	8
Connectors – Type 4.3-10.....	22
Connectors – Type N.....	30
Connectors – Type 2.2-5.....	44
Adaptors.....	48
Inter-Type Adaptors.....	49
Within-Type Adaptors.....	57
Jumper Cable Assemblies.....	62
SpinnerFlex® TopFit.....	63
SpinnerFlex® MultiFit.....	68
SpinnerFlex® Hybrid.....	70
SpinnerFlex® Cable.....	72
Seriflex.....	74
Filters.....	76
Band-Pass Filters.....	77
Band-Stop Filters.....	79
Low-Pass Filters.....	82
Uplink / Downlink Filters.....	83
Combining Products and Systems.....	85
Multiband Combiners.....	86
Multiband Combining Systems.....	112
Sameband Combiners.....	132
Mobile Network Combining System (MNCS®).....	134
Products for Distributed Antenna System (DAS).....	136
Symmetric Splitters.....	138
Asymmetric Splitters.....	148
Directional Couplers.....	158
Antennas.....	166
Absorbing Products.....	170
Loads.....	171
Attenuators.....	183
Surge Protectors.....	188
DC Breaks.....	196
Tools and Accessories.....	198
Index.....	202



## SPINNER Sets Standards in RF Technology

**The SPINNER Group is a globally leading producer of high-quality RF components. Our technical competence and more than 70 years of experience make us a sought-after partner where RF technology is concerned. Based in Munich with production facilities in Germany, Hungary and China, today the SPINNER Group employs more than 1000 highly trained employees.**

### Committed to reduce cost

We are committed to minimizing our customers' operating costs by providing first-rate products and solutions that are planned, designed and manufactured with meticulous attention to every detail. Our success is based on professional development, superior quality, carefully selected materials, and competent personnel. SPINNER supplies a wide range of discrete passive components.

Above and beyond this, we also plan and develop customer-specific solutions based on our Mobile Network Combining Systems (MNCS®) to enable multiple uses of antenna systems. These customized passive solutions are

highly integrated and extremely reliable while also being very flexible.

After our MNCS® systems are installed, there are no additional costs for electric power, spare parts or maintenance. Interruptions in service as a result of system failures or the need to replace discontinued components are a thing of the past. Being modular in structure, they are extremely versatile and can be easily scaled up at any time. This is good to know, since one thing is certain: there will always be yet another generation in mobile communications.

**We invented  
soldered and molded jumpers**



**SPINNER is co-inventor of the  
4.3-10 connector system**



**We invented  
the 7-16 connector system**

## Areas of Application for SPINNER Products and Solutions



Places of interest



Hotels & office buildings



Recreation areas



Government buildings



Tunnels

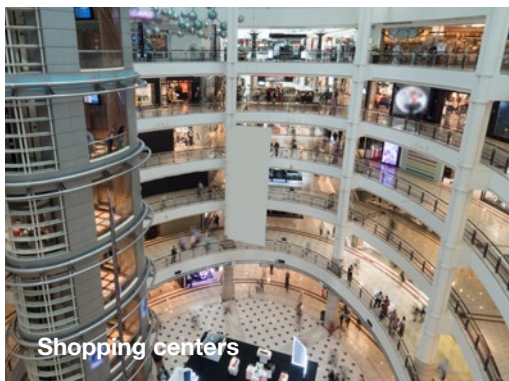

Shopping centers

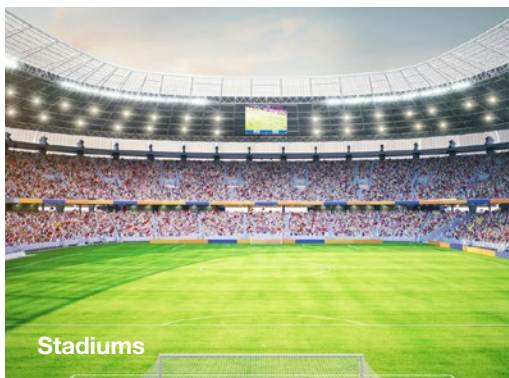

Stadiums

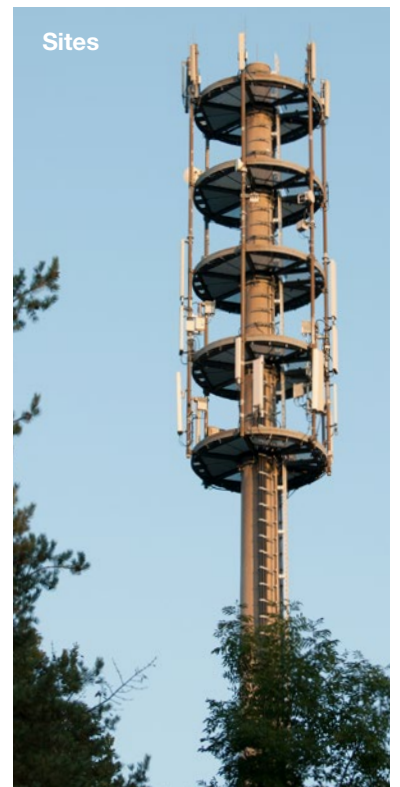

Sites

## Passive Intermodulation – PIM

In the mobile communication market, there is a lot of talk about the need for low passive intermodulation, also referred to as "low PIM". This is a very important topic and one that is often underestimated and occasionally even abused for marketing purposes.

### PIM is still underestimated

Today's mobile communication networks already use three to five different bands simultaneously. And most new growth is achieved by adding even more frequency bands. Transmitting such a large number of different frequencies through the same medium greatly increases the risk of PIM. Consequently, today it is becoming more important than ever to use PIM-resistant products.

SPINNER was one of the first manufacturers to recognize the risks of PIM, back in the early days of mobile communications. And as a result, we have now spent more than 20 years intentionally developing our mobile communication products to keep passive intermodulation as low as possible.

There are widely diverging views in the market on how to define a product as "low PIM". Astonishingly, it has even become common to describe products afflicted by intermodulation of  $-140$  dBc (IM3 @  $2 \times 20$  W) as having low PIM. At SPINNER, we don't refer to a product as "low PIM" unless final tests show levels below the  $-160$  dBc threshold. In many of our data sheets, we also list not only the guaranteed value but also a typical value, e.g.  $-165$  dBc. And even this excellent typical level is surpassed by about 80% of our products.

### PIM must be considered end-to-end

It's important to note that a product's IM grade doesn't only depend on the product itself. It also depends on the environment in which it is tested. According to IEC recommendation 62037-1, a test system's own intermodulation must be 10 dB better than the value of a tested object. This requirement extends to all components involved in testing, including cables, switches and terminating resistors. If it isn't met, the measurement tolerance becomes much larger, greatly increasing the probability of errors.

As a leading producer of low intermodulation test equipment, we take this recommendation very seriously and consistently apply it to our test environments and for testing our own products.

In the future as well, we will remain committed to taking the topic of intermodulation very seriously. We guarantee you the best possible mobile communication products and test equipment and components, and we want to continue being your reliable partner. This lets you save quite a bit of money in the long run. Lower costs for maintenance and servicing may not always be an obvious consequence of excellent RF components. But we feel obliged to help you achieve them. Thank you for placing your confidence in us!





Back in 1997: SPINNER's first PIM test bench



## Connectors

SPINNER has a long tradition of producing high-quality connectors. The first "carrier-grade" 6-16 (60 Ω) connector was invented by Dr. Georg Spinner back in 1949. It served as the basis for developing the 7-16 (50 Ω) version, which is the most widely used connector system in the mobile communication market today.

All SPINNER connectors possess excellent electrical and mechanical properties. The details of the individual connector systems are covered in the following chapters. On this page, we briefly acquaint you with the Cut And Fit (CAF®) and MultiFit cable clamp systems used by SPINNER.

Cable Clamp Systems (called "Version" on the next pages)	Benefits
<p><b>SPINNER Cut and Fit (CAF®) Plast2000</b></p> 	<ul style="list-style-type: none"> <li>■ Ultra-safe IP68-rated protection based on Plast2000 sealing</li> <li>■ For SpinnerFlex® and RFS cables</li> </ul>
<p><b>SPINNER Cut and Fit (CAF®)</b></p>  <p>SPINNER CAF® profile gasket      SPINNER CAF® O-ring      SPINNER CAF® heat shrink sleeve</p>	<ul style="list-style-type: none"> <li>■ Quick and safe single-step installation in less than two minutes</li> <li>■ Sealing by profile gasket, O-ring or heat shrink sleeve</li> <li>■ For SpinnerFlex® and RFS cables</li> </ul>
<p><b>SPINNER MultiFit®</b></p>  <p>SPINNER MultiFit® profile gasket      SPINNER MultiFit® O-ring</p>	<ul style="list-style-type: none"> <li>■ Quick and safe two-step installation in about two minutes</li> <li>■ Sealing by profile gasket or O-ring</li> <li>■ For all commercially available cables</li> </ul>



### Installation

We show you how to install our connectors for different cable sizes and cable clamp systems in videos on our YouTube channel. You can find more information in our installation guides: <https://www.youtube.com/user/spinnergmbh>

## Connectors – Type 7-16



**The 7-16 connector has become the most widely used coaxial connection system for mobile communication systems, due to its excellent mechanical and electrical properties.**

In order to achieve the industry leading inter-modulation performance (typically -165 dBc), SPINNER applies silver-plating on all inner and outer conductor parts of the connector. As a supporting measure we use exclusively non-magnetic materials, and we have minimized the number of RF contact points.

The connection is especially suited for transmitting medium or high power signals, up to a frequency of 8.3 GHz. Most of our connectors are suited with a special SPINNER coupling nut.



**The 50  $\Omega$  connector 7-16 is a variant of the connector system 6-16 (60  $\Omega$ ) developed 1949 by Dr. Georg Spinner. The designation is derived from the metric dimensions of the inner and outer conductor.**



## Connectors – Type 7-16

Electrical	IEC 61169-4	Remark
Nominal impedance	50 $\Omega$	
Frequency range	0 - 7.5 GHz	SPINNER: 0 - 8.3 GHz
Passive intermodulation (IM3) @ 2 x 20 W	$\leq -155$ dBc	SPINNER: $\leq -165$ dBc
VSWR	$\leq 1.22$	Straight connector, up to 6 GHz
Center contact resistance	$\leq 0.4$ m $\Omega$	Initial
Outer contact continuity	$\leq 1.50$ m $\Omega$	Initial
Insulation resistance	$\geq 10$ G $\Omega$	Initial
Proof voltage at sea level	3 kV	50 - 60 Hz
Screening effectiveness	$\geq 110$ dB	Straight cable connectors, up to 1 GHz

Mechanical	IEC 61169-4	Remark
Coupling torque	30 Nm	
Proof torque		SPINNER: 55 Nm
Tensile strength of coupling mechanism	445 N	SPINNER: 1000 N
Mechanical lifetime	500	Operations
Center contact captivation		Yes

Environmental	IEC 61169-4	Remark
Climatic category	55/155/56	
Degree of protection (mated)		SPINNER: IP 68

Materials and Surface Finish	
Resilient contact parts	High strength copper alloy, silver plated
Insulation	PTFE/FEP
Center and outer conductor parts	Copper alloy, silver plated and/or CuSnZn plated
Other metal parts	Copper alloy, bright nickel plated and/or tin plated
Gaskets	Silicone rubber

## Connectors – Type 7-16

### Cable Connector for SF 1/4"-50 Cables

Style	Version	Part Number
Male	CAF®	BN 741460

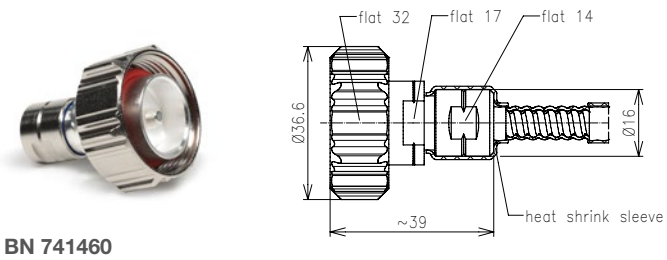

### Cable Connectors for SF 3/8"-50 Cables

Style	Version	Part Number
Male	CAF®	BN 847339
Male right angle	CAF®	BN 847373
Female	CAF®	BN 710339

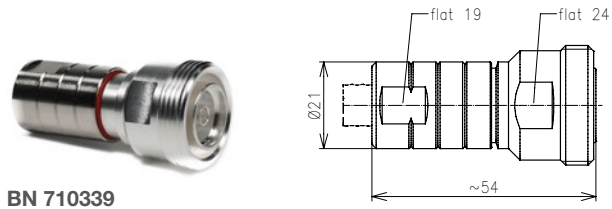
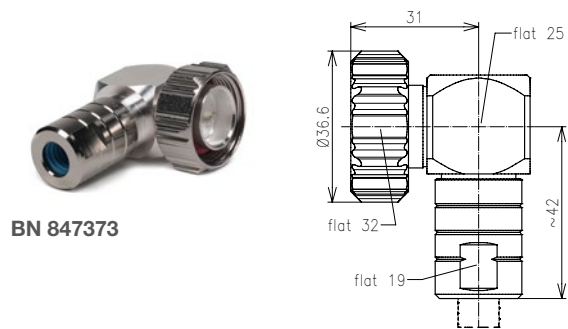
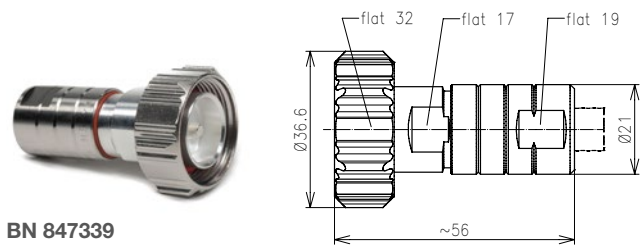

## Connectors – Type 7-16

### Cable Connectors for SF 1/2"-50 Cables

Style	Version	Part Number
Male	CAF®	<b>BN 847359</b>
Male	MultiFit	<b>BN 847371</b>
Male right angle	CAF®	<b>BN 847357</b>
Male right angle	MultiFit	<b>BN 847374</b>
Female	CAF®	<b>BN 710359</b>
Female	MultiFit	<b>BN 710371</b>



**BN 847359**

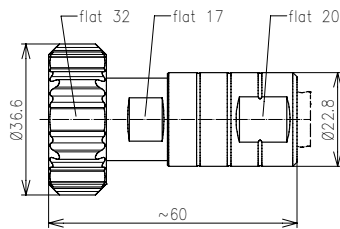

**BN 847371**

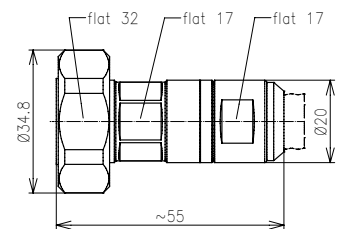

**BN 847357**

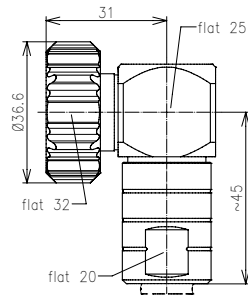

**BN 847374**

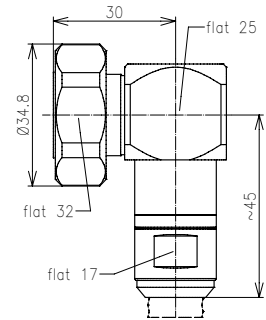

**BN 710359**

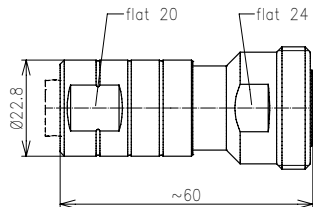

**BN 710371**

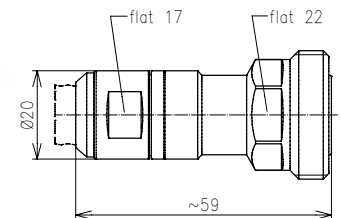

## Connectors – Type 7-16

### Cable Connector for LF 1/4"-50 Cables

Style	Version	Part Number
Male	CAF®	BN 741445



BN 741445

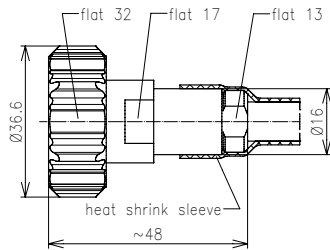

### Cable Connector for LF 3/8"-50 Cables

Style	Version	Part Number
Male	CAF®	BN 847369



BN 847369

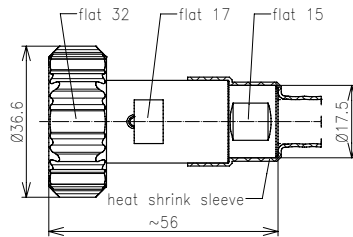

## Connectors – Type 7-16

### Cable Connectors for LF 1/2"-50 Cables

Style	Version	Part Number
Male	CAF® Plast2000	<b>BN 847368</b>
Male	CAF® O-ring	<b>BN 847389</b>
Male	MultiFit	<b>BN 854317</b>
Male right angle	CAF® Plast2000	<b>BN 847356</b>
Male right angle	CAF® O-ring	<b>BN 847391</b>
Male right angle	MultiFit	<b>BN 854316</b>
Female	CAF® Plast2000	<b>BN 710368</b>
Female	CAF® O-ring	<b>BN 710389</b>
Female	MultiFit	<b>BN 654317</b>



**BN 847368**

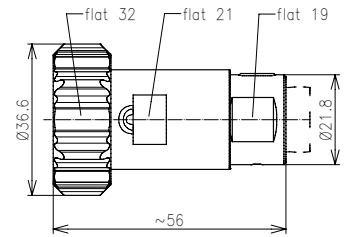

**BN 847389**

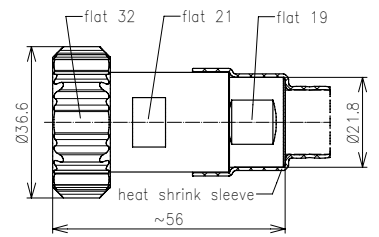

**BN 854317**

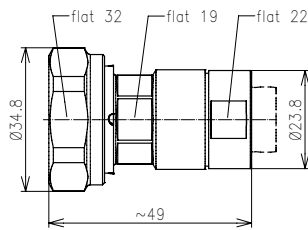

**BN 847356**

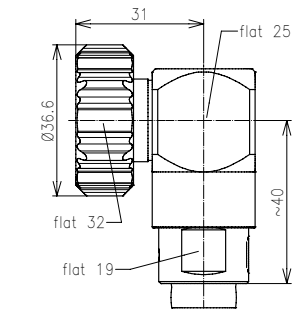

**BN 847391**

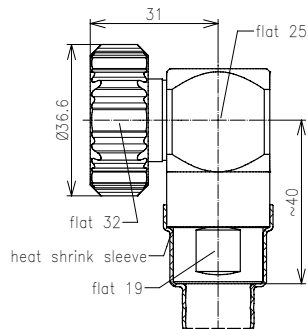

**BN 854316**

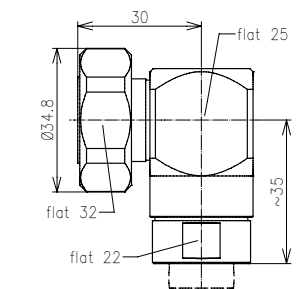

**BN 710368**

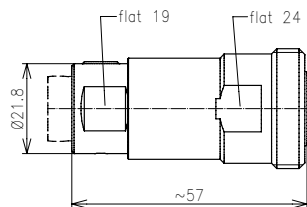

**BN 710389**

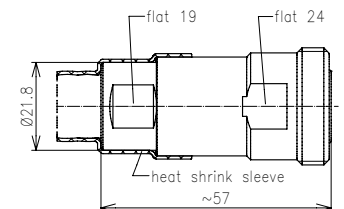

**BN 654317**

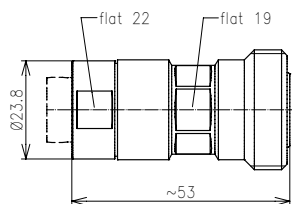

## Connectors – Type 7-16

### Cable Connectors for LF 7/8"-50 Cables

Style	Version	Part Number
Male	CAF® Plast2000	<b>BN 844840</b>
Male	CAF® O-ring	<b>BN 844841</b>
Male	MultiFit	<b>BN 854302</b>
Male right angle	CAF® Plast2000	<b>BN 844850</b>
Male right angle	CAF® O-ring	<b>BN 844851</b>
Male right angle	MultiFit	<b>BN 854309</b>
Female	CAF® Plast2000	<b>BN 655640</b>
Female	CAF® O-ring	<b>BN 655641</b>
Female	MultiFit	<b>BN 654302</b>



**BN 844840**

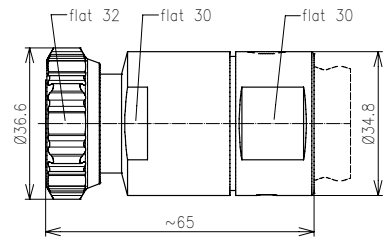

**BN 844841**

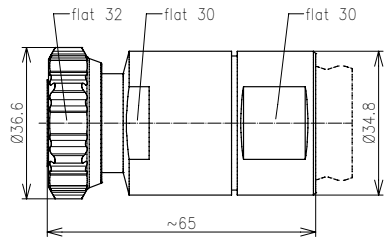

**BN 854302**

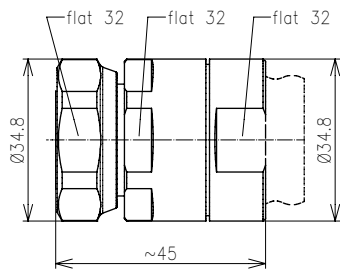

**BN 844850**

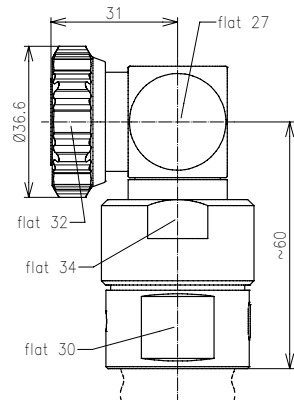

**BN 844851**

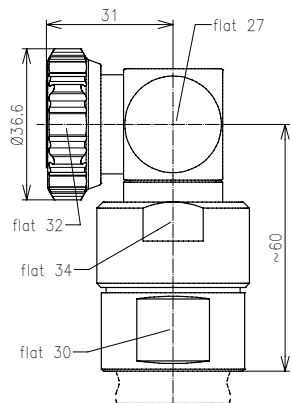

**BN 854309**

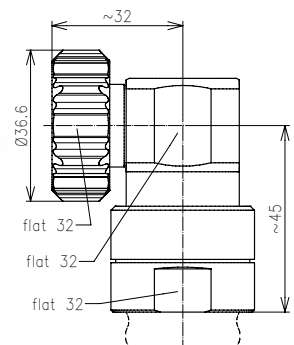

**BN 655640**

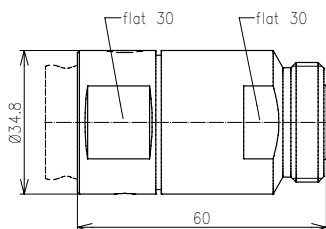

**BN 655641**

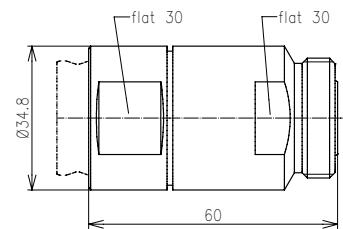

## Connectors – Type 7-16

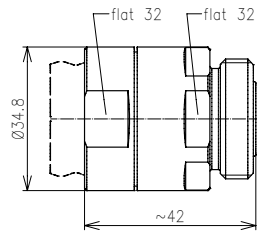

**BN 654302**

### Cable Connectors for LF 1 1/4"-50 Cables

Style	Version	Part Number
Male	CAF® Plast2000	<b>BN 844842</b>
Male	MultiFit	<b>BN 854320</b>
Female	CAF® Plast2000	<b>BN 655642</b>
Female	MultiFit	<b>BN 654320</b>

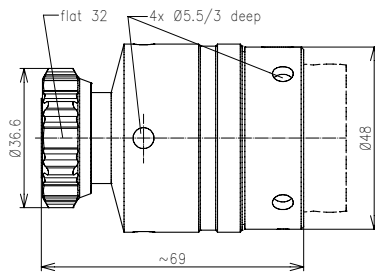

**BN 844842**

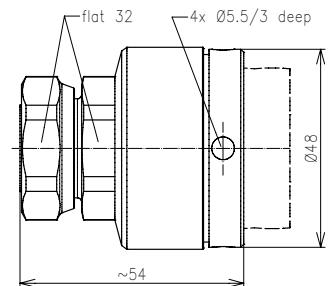

**BN 854320**

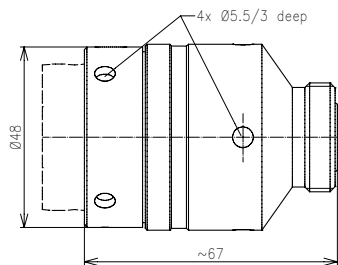

**BN 655642**

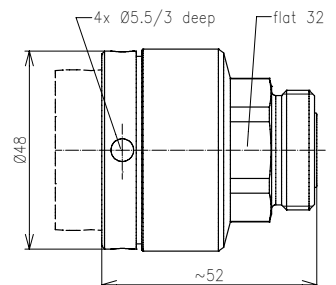

**BN 654320**

## Connectors – Type 7-16

Cable Connectors for LF 1 5/8"-50 Cables

Style	Version	Part Number
Male	CAF® Plast2000	BN 844844
Male	MultiFit	BN 854322
Female	CAF® Plast2000	BN 655644
Female	MultiFit	BN 654322

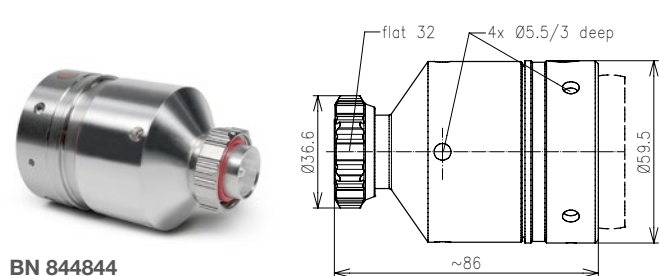

BN 844844

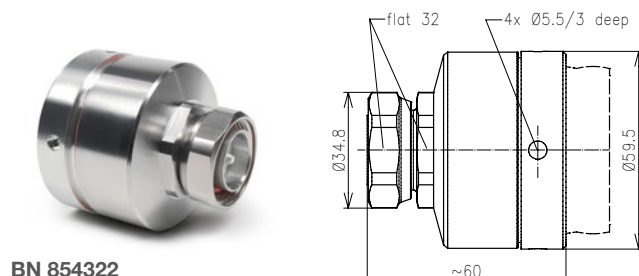

BN 854322

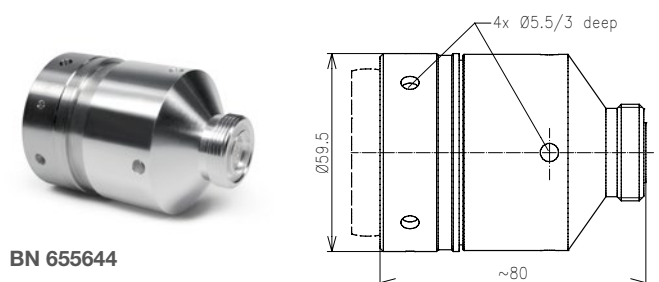

BN 655644

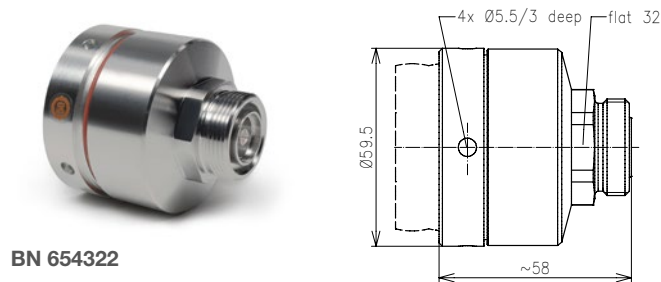

BN 654322



## Connectors – Type 7-16

### Cable Connectors for LF 2 1/4"-50 Cables

Style	Version	Part Number
Male	CAF® Plast2000	<b>BN 844873</b>
Male	CAF® O-ring	<b>BN 844863</b>
Female	CAF® Plast2000	<b>BN 655673</b>
Female	CAF® O-ring	<b>BN 655663</b>

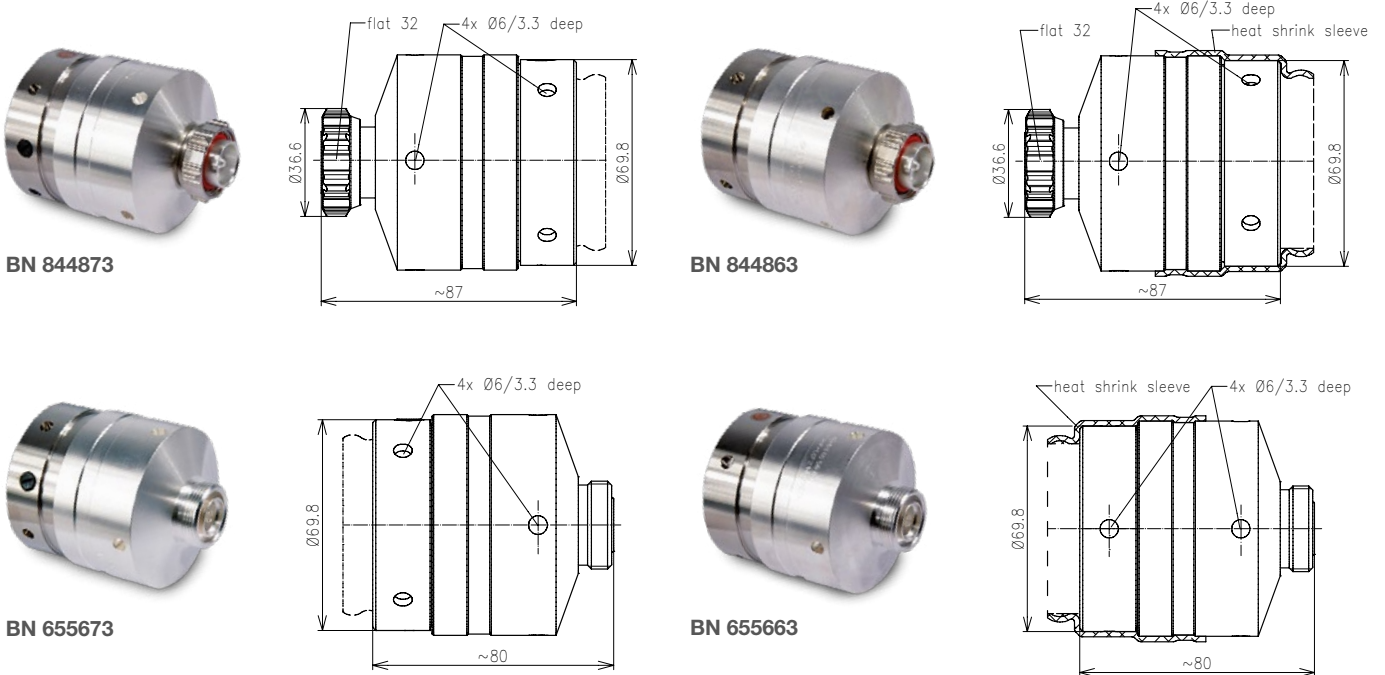

## Connectors – Type 7-16

### Cable Connectors for Radiating Cables

Cable Type	Style	Version	Part Number
RADIAFLEX® 78-50	Male	Heat shrink sleeve	<b>BN 557152</b>
RADIAFLEX® 78-50	Female	Heat shrink sleeve	<b>BN 557153</b>
RADIAFLEX® 114-50A	Female	Heat shrink sleeve	<b>BN 557163</b>
RADIAFLEX® 158-50A	Female	Heat shrink sleeve	<b>BN 557173</b>

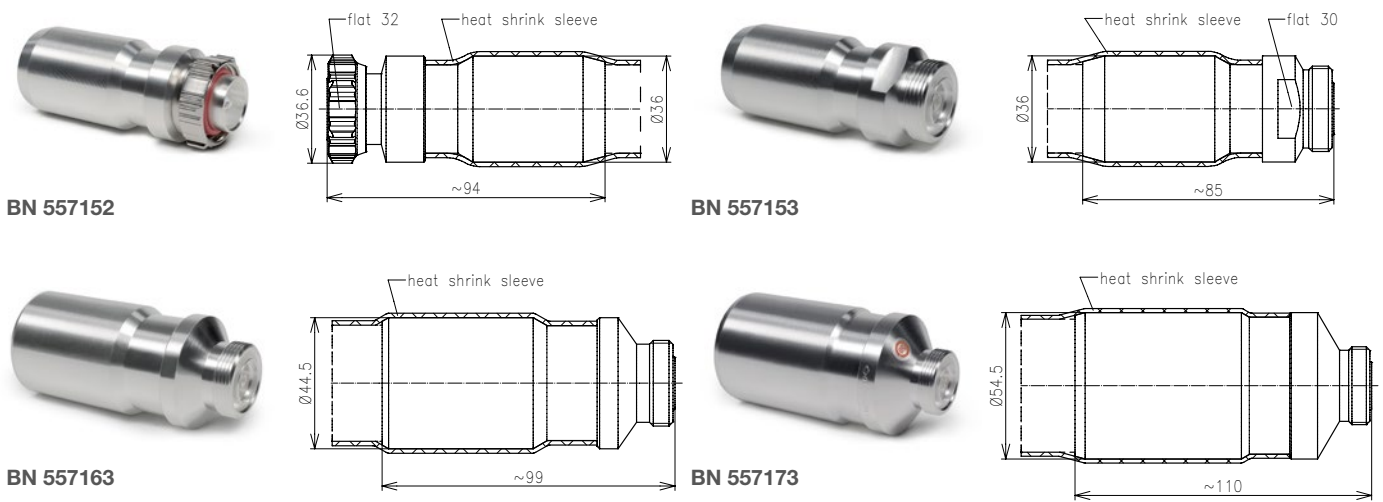

### Cable Connectors for RG Cables

Cable Type	Style	Version	Part Number
Seriflex 141-50; RG 402/U	Male	Soldered	<b>BN 807625</b>
Seriflex 141-50; RG 402/U	Female bulkhead	Soldered; panel sealed	<b>BN 807788</b>
Seriflex 141-50; RG 402/U	Female four-hole flange	Soldered	<b>BN 807706</b>
Seriflex 141-50; RG 402/U	Female four-hole flange	Soldered; panel sealed	<b>BN 807750</b>
Seriflex 250-50; RG 401/U	Male	Soldered	<b>BN 807621</b>
Seriflex 250-50; RG 401/U	Female bulkhead	Soldered; panel sealed	<b>BN 807733</b>
Seriflex 250-50; RG 401/U	Female four-hole flange	Soldered	<b>BN 807752</b>
RG 214/U; RG 393/U	Male	Clamped	<b>BN 951820</b>
RG 214/U; RG 393/U	Male, straight and right angle mounting	Clamped	<b>BN 807680</b>
RG 214/U; RG 393/U	Female	Clamped	<b>BN 951920</b>



## Connectors – Type 7-16

### Cable Connectors for RG Cables

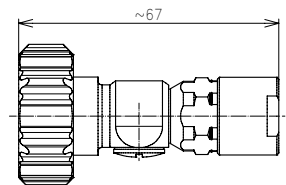
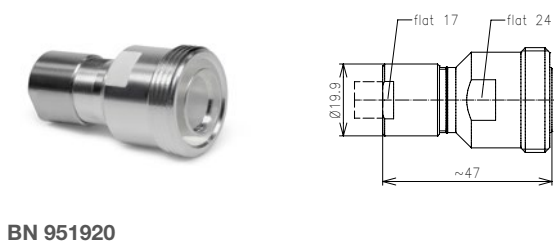
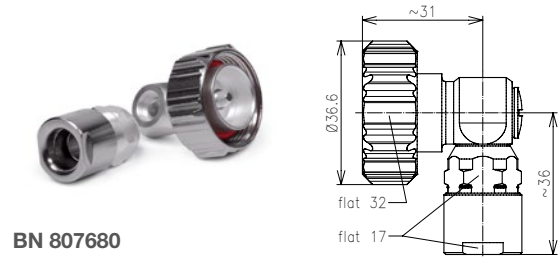
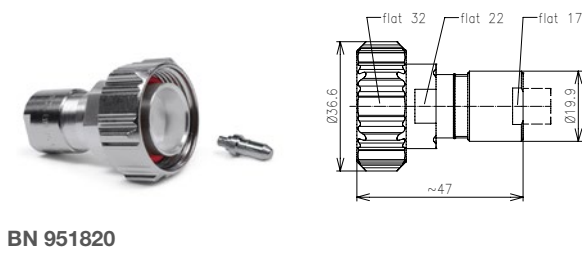
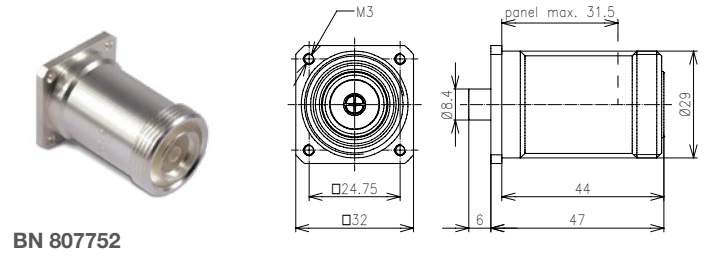
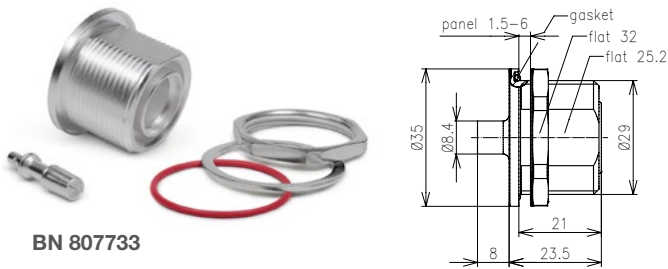
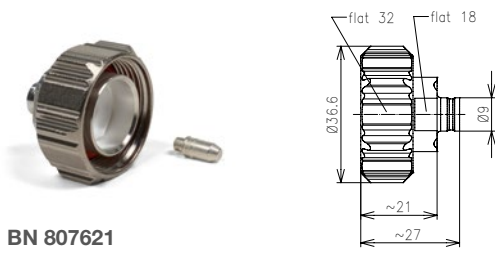
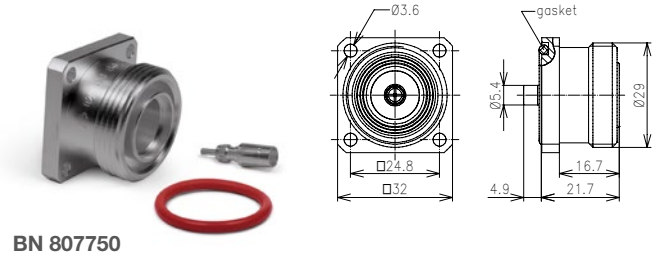
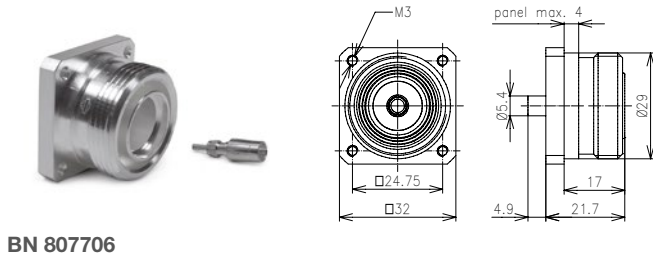

## Connectors – Type 7-16

### Connector Head

Style	Part Number
Male, straight and right angle mounting	BN 450995

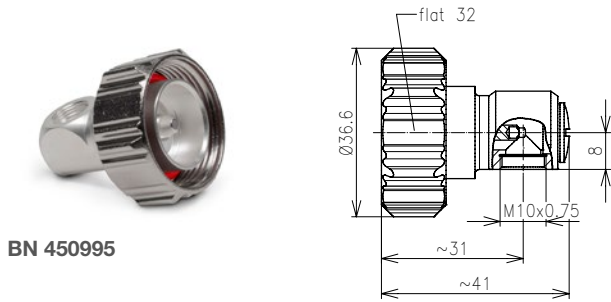

BN 450995

### Cable Entries

Cable Type	Version	Part Number
RG 55 B/U RG 58 C/U RG 142 B/U RG 223/U RG 400/U	Clamped	BN 419400
RG 213/U	Clamped	BN 420100
RG 214/U RG 216/U RG 393/U	Clamped	BN 982900
RG 214/U RG 393/U	Crimped	BN 982911

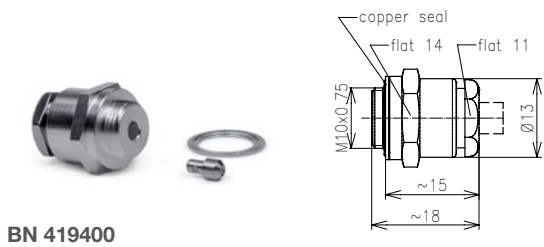

BN 419400

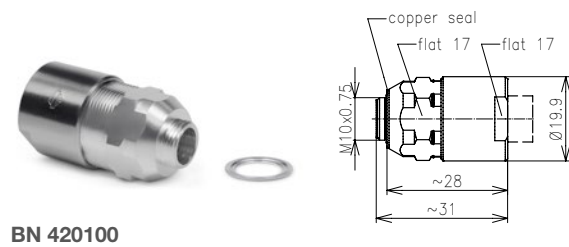

BN 420100

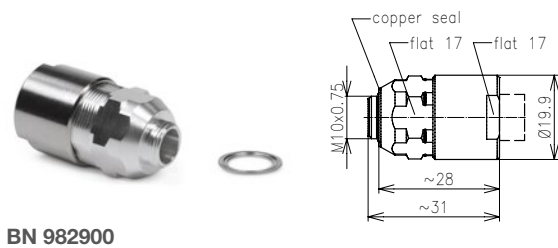

BN 982900

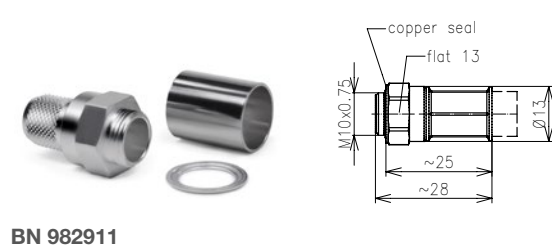

BN 982911

## Connectors – Type 7-16

### Fixed Connectors

Style	Version	Part Number
Male four-hole flange	Inner conductor solder cup; panel sealed	<b>BN 954716</b>
Male four-hole flange	Inner conductor M3; panel sealed	<b>BN 954765</b>
Female four-hole flange	Inner conductor solder cup	<b>BN 954510</b>
Female four-hole flange	Inner conductor M3; panel sealed	<b>BN 954684</b>

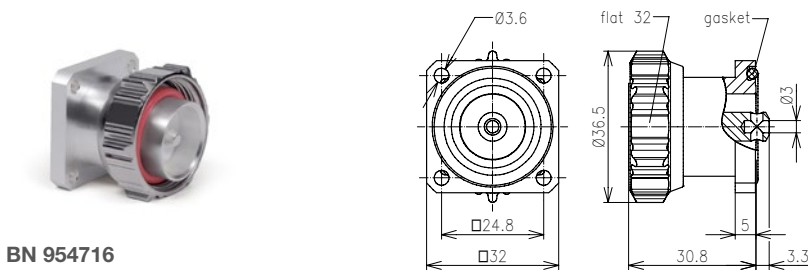

**BN 954716**

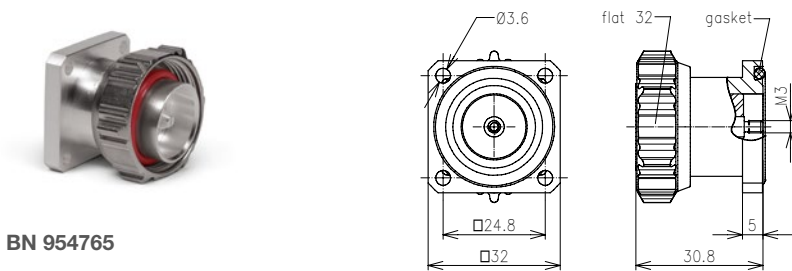

**BN 954765**

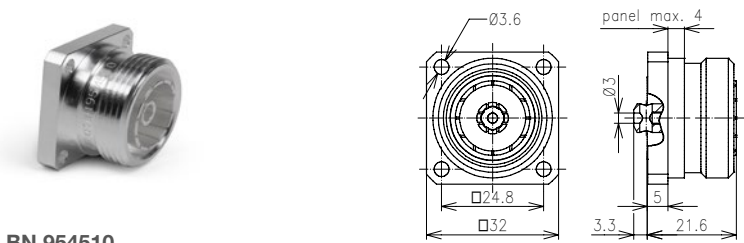

**BN 954510**

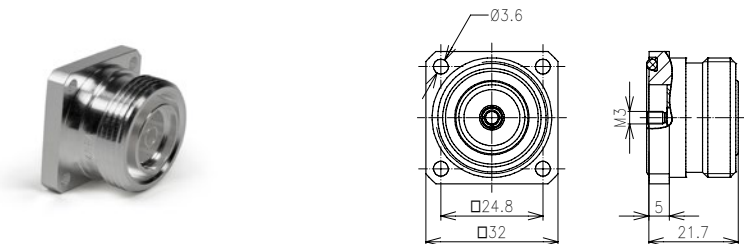

**BN 954684**

## Connectors – Type 4.3-10



**4.3-10 is the most advanced coaxial connector system. It was developed specifically to meet the requirements of today’s mobile communication market. It boasts outstanding electrical and mechanical properties, and best of all it is characterized by extremely low passive intermodulation.**

### Best connector system in the market

Its compactness compared to conventional connector systems and its low coupling torque contribute to making it excellently suited for mobile communication systems. In older connector systems for mobile communication applications, the electrical and mechanical reference planes are identical. The 4.3-10 standard separates them, thus

significantly reducing the required coupling torque and ensuring more reliable contact. This separation also makes the system less susceptible to faults. Besides the screw version (installed using a tool), hand-screw and push-pull versions are also available.



Three different coupling mechanisms: screw - hand screw - push-pull



**In 2014, SPINNER and other leading connector suppliers jointly developed the 4.3-10 connector system for the mobile communication market. By separating the electrical and mechanical reference planes best intermodulation values at low coupling torque can be achieved.**

## Connectors – Type 4.3-10

Electrical	IEC 61169-54	Remark
Nominal impedance	50 $\Omega$	
Frequency range	0 - 6 GHz	Grade 2: 0 – 6 GHz Grade 0 and 1: 0 – 12 GHz
Passive intermodulation (IM3) @ 2 x 20 W	$\leq -166$ dBc	
VSWR	$\leq 1.05$	Straight connector, up to 6 GHz
Center contact resistance	$\leq 1.0$ m $\Omega$	Initial
Outer contact continuity	$\leq 1.0$ m $\Omega$	Initial
Insulation resistance	$\geq 5$ G $\Omega$	Initial
Proof voltage at sea level	2.5 kV	50 - 60 Hz
Screening effectiveness	$\geq 110$ dB	Screw type, up to 6 GHz

Mechanical	IEC 61169-54	Remark
Coupling torque	5 Nm	Screw type only
Proof torque	7 Nm	Screw type only
Tensile strength of coupling mechanism	445 N	
Mechanical lifetime	100 Cycles/Operations	SPINNER: 500 operations
Center contact captivation		Yes

Environmental	IEC 61169-54	Remark
Climatic category	55/125/56	
Degree of protection (mated)		SPINNER: IP 68

Materials and Surface Finish	
Resilient contact parts	High strength copper alloy, silver plated
Insulation	PTFE/FEP
Center and outer conductor parts	Copper alloy, silver plated and/or CuSnZn plated
Other metal parts	Copper alloy, bright nickel plated and/or tin plated
Gaskets	Silicone rubber

## Connectors – Type 4.3-10

### Cable Connectors for SF 1/4"-50 Cables

Style	Version	Part Number
Male, screw type	CAF®	<b>BN 431100</b>
Male, hand screw type	CAF®	<b>BN 431103</b>
Male, push-pull type	CAF®	<b>BN 431104</b>

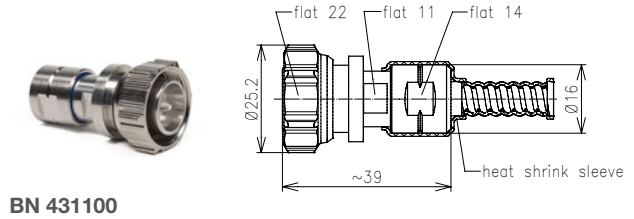

### Cable Connectors for SF 3/8"-50 Cables

Style	Version	Part Number
Male, screw type	CAF®	<b>BN 431101</b>
Male, hand screw type	CAF®	<b>BN 431105</b>
Male, push-pull type	CAF®	<b>BN 431106</b>
Male right angle, screw type	CAF®	<b>BN 431107</b>
Male right angle, hand screw type	CAF®	<b>BN 431108</b>
Male right angle, push-pull type	CAF®	<b>BN 431109</b>

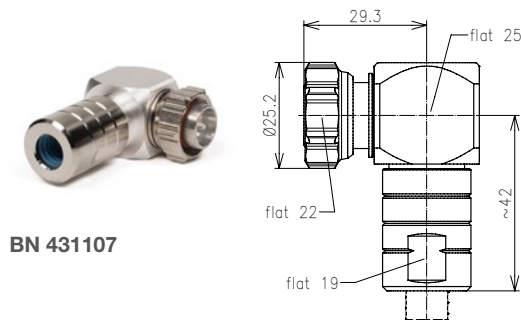
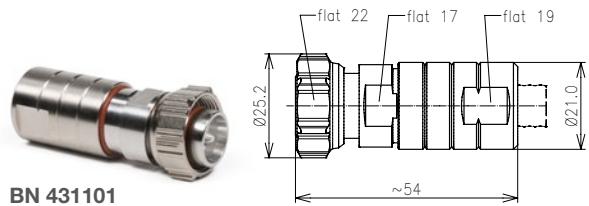

### Cable Connectors for SF 1/2"-50 Cables

Style	Version	Part Number
Male, screw type	MultiFit	<b>BN 431171</b>
Male, hand screw type	MultiFit	<b>BN 431110</b>
Male, push-pull type	MultiFit	<b>BN 431111</b>
Male right angle, screw type	MultiFit	<b>BN 431174</b>
Male right angle, hand screw type	MultiFit	<b>BN 431113</b>
Male right angle, push-pull type	MultiFit	<b>BN 431114</b>
Female	MultiFit	<b>BN 431112</b>

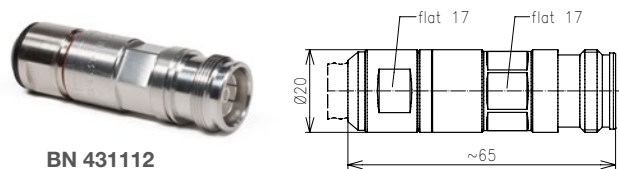
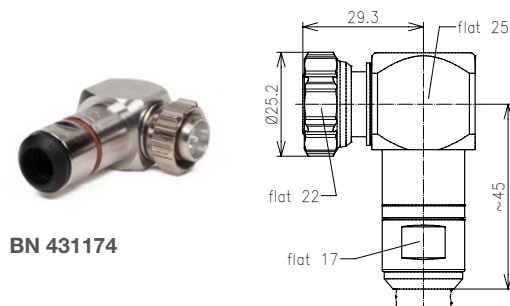
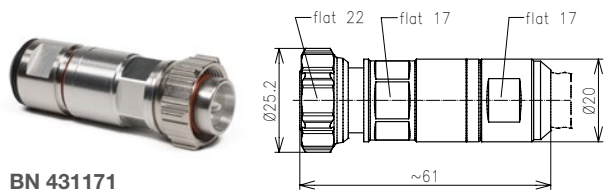



## Connectors – Type 4.3-10

### Cable Connectors for LF 1/2"-50 Cables

Style	Version	Part Number
Male, screw type	CAF® Plast2000	<b>BN 431168</b>
Male, screw type	MultiFit	<b>BN 431117</b>
Male, hand screw type	MultiFit	<b>BN 431115</b>
Male, push-pull type	MultiFit	<b>BN 431118</b>
Male right angle, screw type	MultiFit	<b>BN 431116</b>
Male right angle, hand screw type	MultiFit	<b>BN 431119</b>
Male right angle, push-pull type	MultiFit	<b>BN 431121</b>
Female	CAF® Plast2000	<b>BN 431068</b>
Female	MultiFit	<b>BN 431017</b>

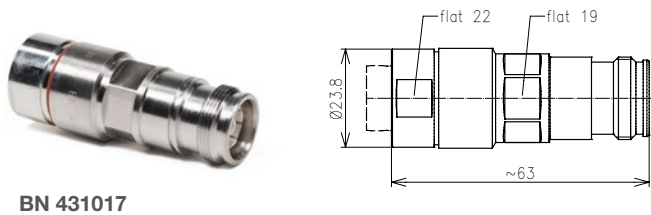
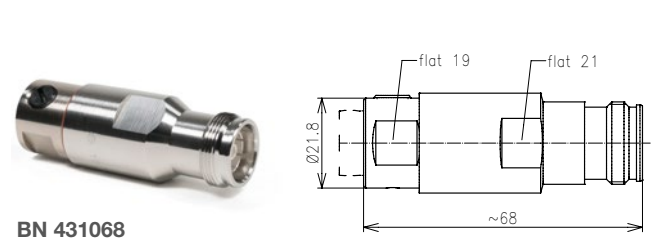
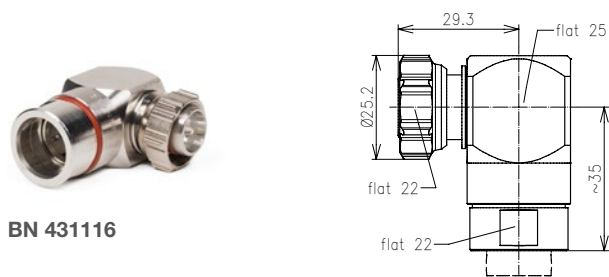
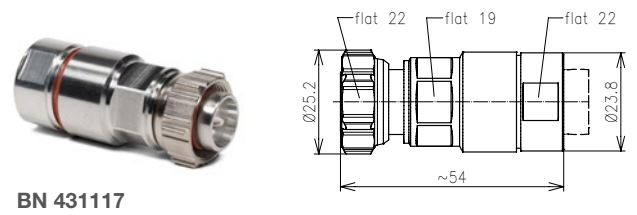
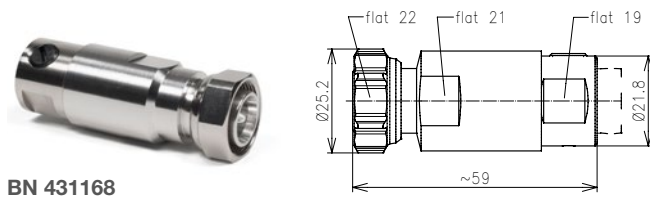

## Connectors – Type 4.3-10

### Cable Connectors for LF 7/8"-50 Cables

Style	Version	Part Number
Male, screw type	CAF® Plast2000	<b>BN 431140</b>
Male, screw type	MultiFit	<b>BN 431102</b>
Male, hand screw type	MultiFit	<b>BN 431123</b>
Male, push-pull type	MultiFit	<b>BN 431124</b>
Male right angle, screw type	MultiFit	<b>BN 431133</b>
Female	CAF® Plast2000	<b>BN 431040</b>
Female	MultiFit	<b>BN 431002</b>

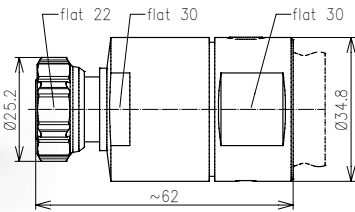

**BN 431140**

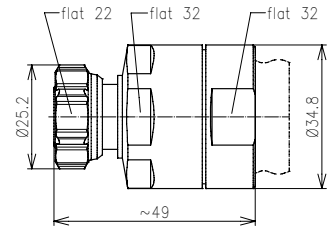

**BN 431102**

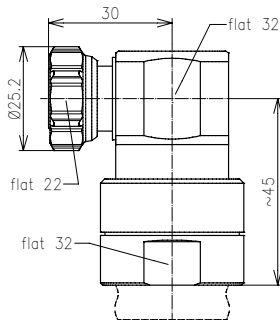

**BN 431133**

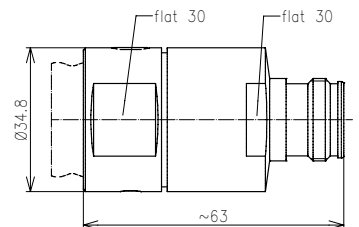

**BN 431040**

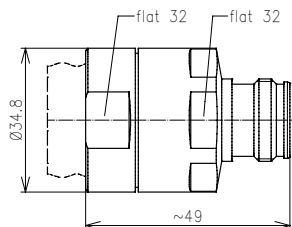

**BN 431002**

## Connectors – Type 4.3-10

### Cable Connectors for LF 1 1/4"-50 Cables

Style	Version	Part Number
Male, screw type	MultiFit	<b>BN 431120</b>
Male, hand screw type	MultiFit	<b>BN 431125</b>
Male, push-pull type	MultiFit	<b>BN 431126</b>
Female	MultiFit	<b>BN 431020</b>

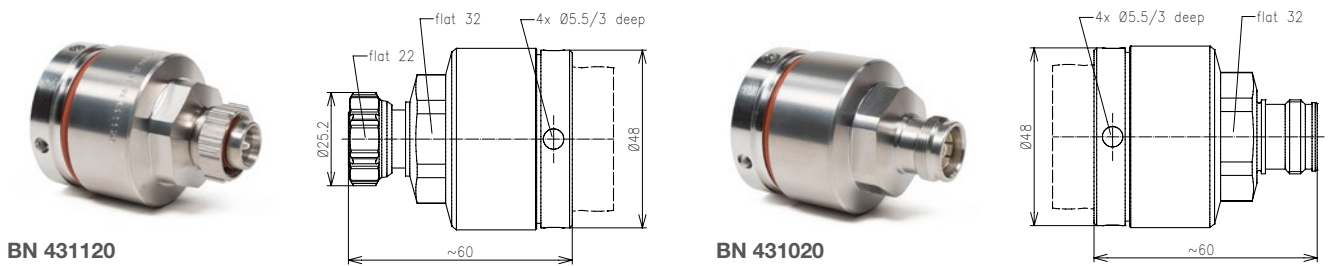

### Cable Connectors for LF 1 5/8"-50 Cables

Style	Version	Part Number
Male, screw type	MultiFit	<b>BN 431122</b>
Male, hand screw type	MultiFit	<b>BN 431127</b>
Male, push-pull type	MultiFit	<b>BN 431128</b>
Female	MultiFit	<b>BN 431022</b>

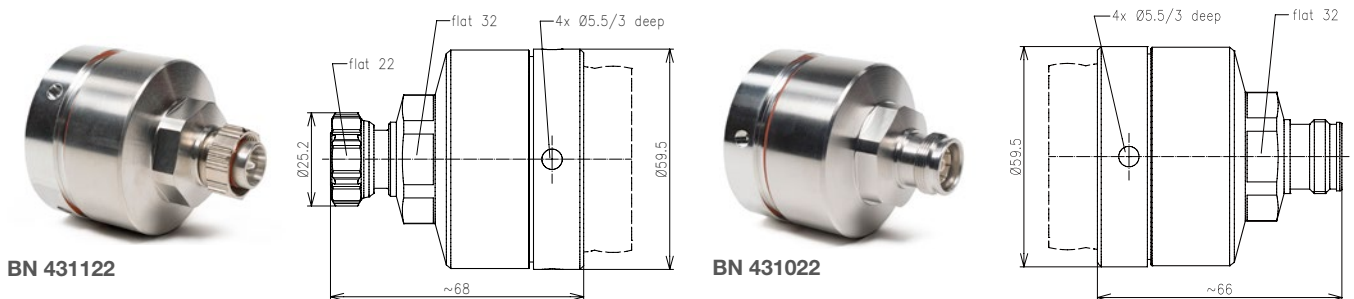

## Connectors – Type 4.3-10

### Cable Connectors for LMR-400 (RG8) Cables

Style	Version	Part Number
Male, screw type	Crimped	<b>BN 431130</b>
Male, hand screw type	Crimped	<b>BN 431131</b>
Male, push-pull type	Crimped	<b>BN 431129</b>



**BN 431130**

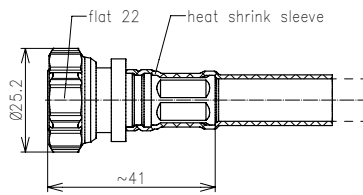

## Connectors – Type 4.3-10

### Fixed Connectors

Cable Type	Style	Version	Part Number
Seriflex 141-50; RG 402/U	Female bulkhead	Soldered; panel sealed	<b>BN 431500</b>
Seriflex 250-50; RG 401/U	Female bulkhead	Soldered; panel sealed	<b>BN 431501</b>
	Female bulkhead	Inner conductor M3; panel sealed	<b>BN 431502</b>
	Female bulkhead	Inner conductor solder cup; panel sealed	<b>BN 431503</b>
Seriflex 141-50; RG 402/U	Female four-hole flange	Soldered	<b>BN 431404</b>
Seriflex 250-50; RG 401/U	Female four-hole flange	Soldered	<b>BN 431403</b>
	Female four-hole flange	Inner conductor M3	<b>BN 431405</b>
	Female four-hole flange	Inner conductor solder cup	<b>BN 431406</b>



**BN 431500**

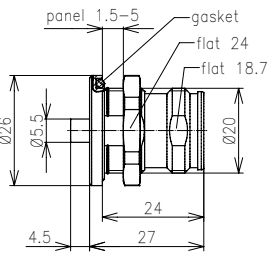

**BN 431501**

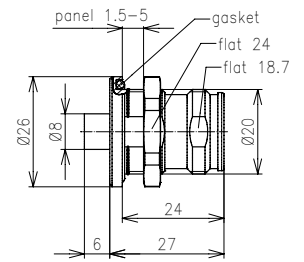

**BN 431502**

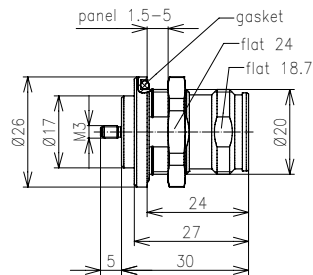

**BN 431503**

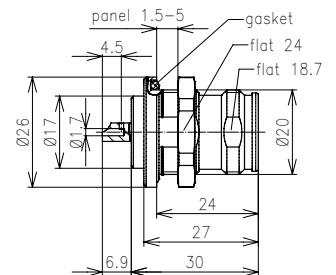

**BN 431404**

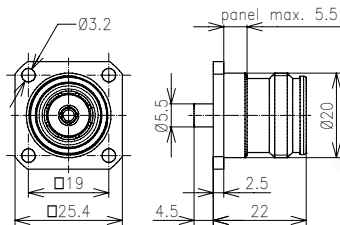

**BN 431403**

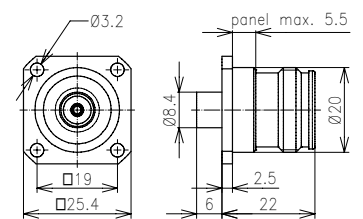

**BN 431405**

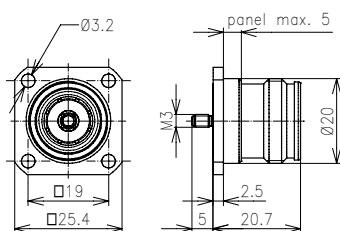

**BN 431406**

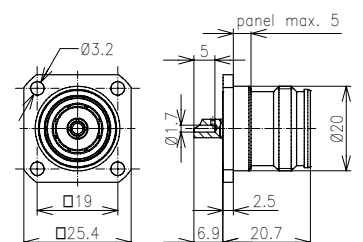

## Connectors – Type N



**Type N connectors can be used at frequencies up to 11 GHz, high-precision types up to 18 GHz. It is typically used in mobile communication applications with demanding mechanical and electrical requirements.**

That is why SPINNER exclusively manufactures N connectors with non-slotted outer conductor contacts and a special sealing profile in the connector head instead of

the flat seal disk, specified by IEC or CECC. This ensures the most reliable sealing function.



The N connectors have been named after their inventor, Paul Neill, who developed this standard in 1942. But frequently the name is also related to Navy Connector.

## Connectors – Type N

Electrical	IEC 61169-16	Remark
Nominal impedance	50 $\Omega$	
Frequency range	0 - 11 GHz 0 - 18 GHz	Grade 2 Grade 0 and 1
Passive intermodulation (IM3) @ 2 x 20 W	Not specified	
VSWR	$\leq 1.30$ $\leq 1.50$	Straight connector, up to 11 GHz Right angle connector, up to 11 GHz
Center contact resistance	$\leq 1.50$ m $\Omega$	Initial
Outer contact continuity	$\leq 1.00$ m $\Omega$	Initial
Insulation resistance	$\geq 5$ G $\Omega$	Initial
Proof voltage at sea level	2.5 kV	50 - 60 Hz
Screening effectiveness	$\geq 90$ dB	Straight cable connectors, up to 1 GHz SPINNER: $\geq 100$ dB

Mechanical	IEC 61169-16	Remark
Coupling torque	0.7 - 1.1 Nm	SPINNER: 3.0 Nm
Proof torque	1.7 Nm	SPINNER: 4.0 Nm
Tensile strength of coupling mechanism	450 N	
Mechanical lifetime	500	Operations
Center contact captivation		Yes

Environmental	IEC 61169-16	Remark
Climatic category	55/155/21	
Degree of protection (mated)		SPINNER: IP 68

Materials and Surface Finish	
Resilient contact parts	High strength copper alloy, silver plated
Insulation	PTFE/FEP
Center and outer conductor parts	Copper alloy, silver plated and/or CuSnZn plated
Other metal parts	Copper alloy, bright nickel plated and/or tin plated
Gaskets	Silicone rubber

## Connectors – Type N

### Cable Connectors for SF 1/4"-50 Cables

Style	Version	Part Number
Male	CAF®	BN 844760
Male right angle	CAF®	BN 757860
Female	CAF®	BN 845560

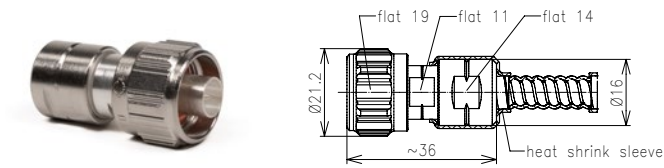

BN 844760

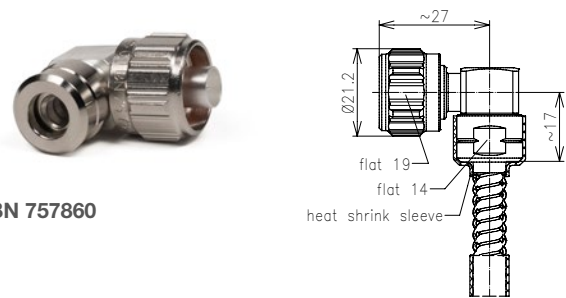

BN 757860



BN 845560

### Cable Connectors for SF 3/8"-50 Cables

Style	Version	Part Number
Male	CAF®	BN 870163
Male, inner conductor gold plated	CAF®	BN 870165
Male right angle, inner conductor gold plated	CAF®	BN 870173
Female	CAF®	BN 846063

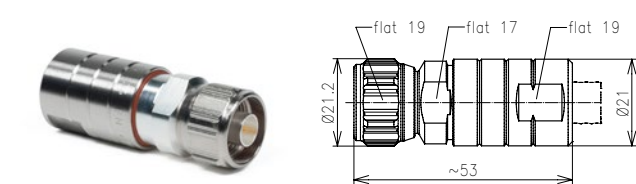

BN 870165

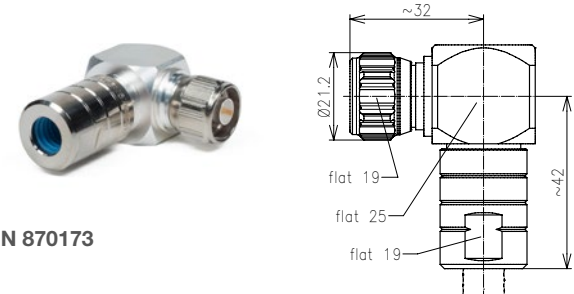

BN 870173

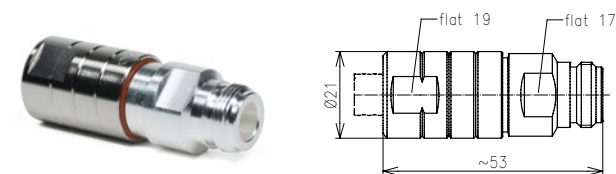

BN 846063



## Connectors – Type N

### Cable Connectors for SF 1/2"-50 Cables

Style	Version	Part Number
Male	CAF®	<b>BN 870157</b>
Male	MultiFit	<b>BN 870171</b>
Male right angle, inner conductor gold plated	CAF®	<b>BN 870156</b>
Male right angle	MultiFit	<b>BN 870174</b>
Female	CAF®	<b>BN 846057</b>
Female	MultiFit	<b>BN 846071</b>

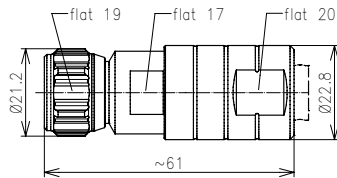

**BN 870157**

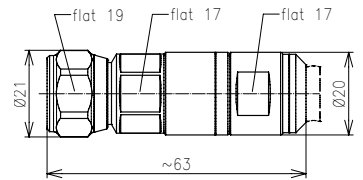

**BN 870171**

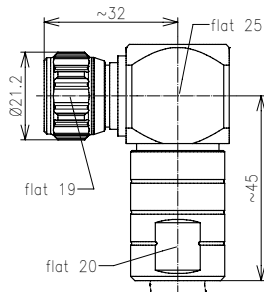

**BN 870156**

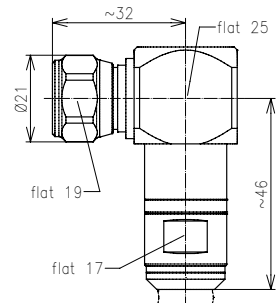

**BN 870174**

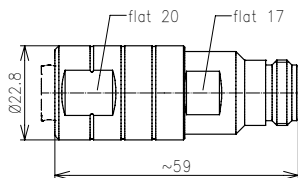

**BN 846057**

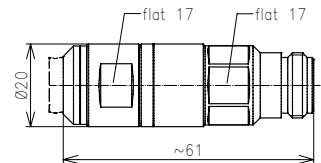

**BN 846071**

## Connectors – Type N

### Cable Connectors for LF 1/4"-50 Cables

Style	Version	Part Number
Male	CAF®	BN 844755
Male right angle	CAF®	BN 757855
Female	CAF®	BN 845555
Female panel mount	CAF®	BN 747645

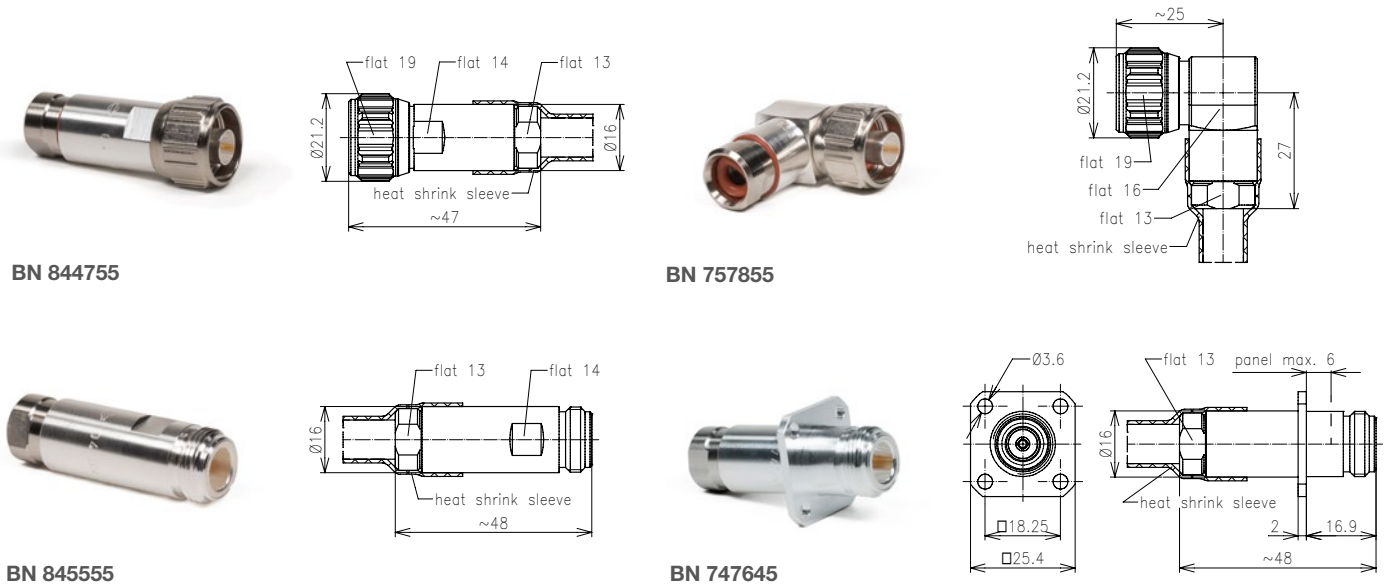

### Cable Connectors for LF 3/8"-50 Cables

Style	Version	Part Number
Male	CAF®	BN 870169
Male right angle	CAF®	BN 870170
Female	CAF®	BN 846069

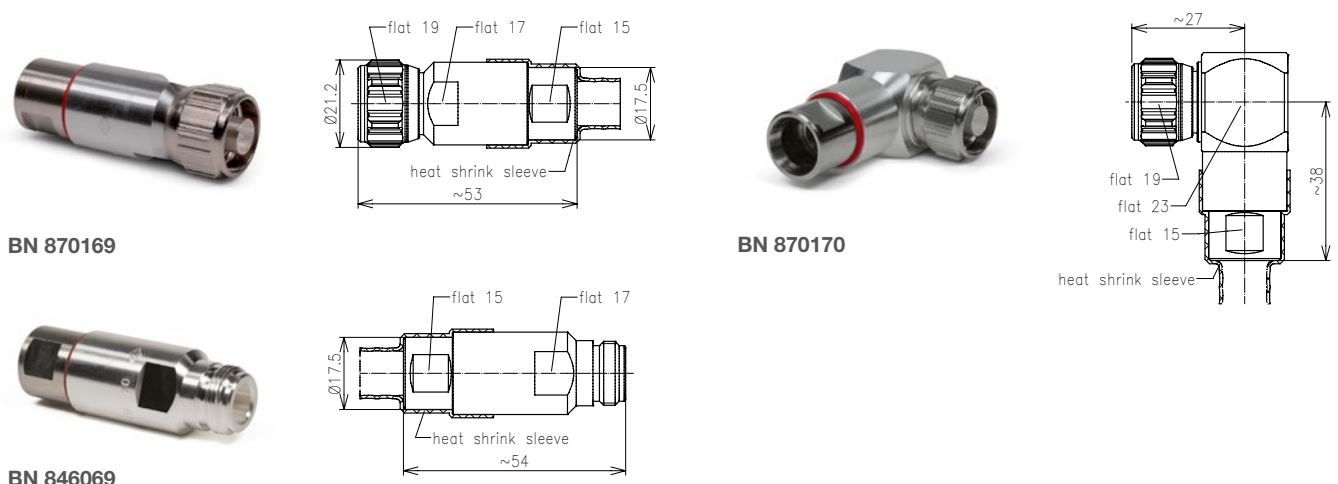

## Connectors – Type N

### Cable Connectors for LF 1/2"-50 Cables

Style	Version	Part Number
Male	CAF® Plast2000	<b>BN 870168</b>
Male	CAF® O-ring	<b>BN 870189</b>
Male	MultiFit	<b>BN 706417</b>
Male right angle	CAF® Plast2000	<b>BN 870167</b>
Male right angle	CAF® O-ring	<b>BN 870187</b>
Male right angle	MultiFit	<b>BN 706416</b>
Female	CAF® Plast2000	<b>BN 846068</b>
Female	CAF® O-ring	<b>BN 846089</b>
Female	MultiFit	<b>BN 846417</b>
Female four-hole flange	CAF® Plast2000	<b>BN 747544</b>



**BN 870168**

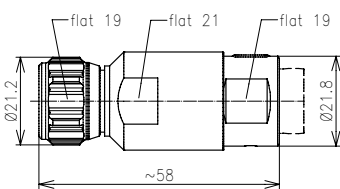

**BN 870189**

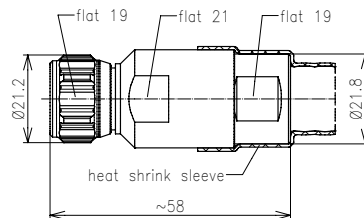

**BN 706417**

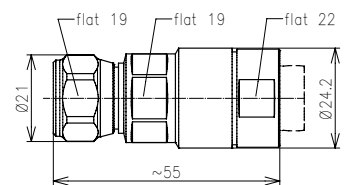

**BN 870167**

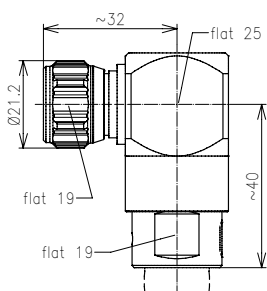

**BN 870187**

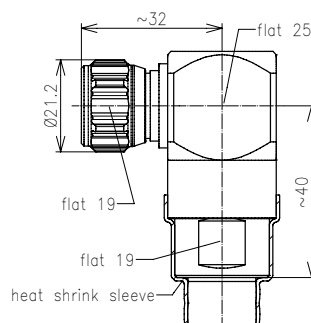

**BN 706416**

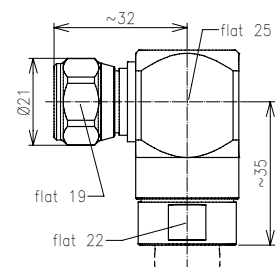

## Connectors – Type N

### Cable Connectors for LF 1/2"-50 Cables

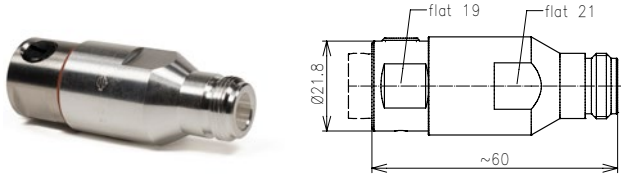

**BN 846068**

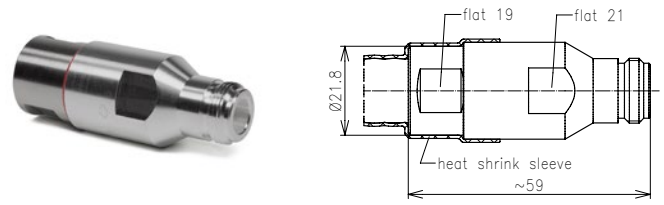

**BN 846089**

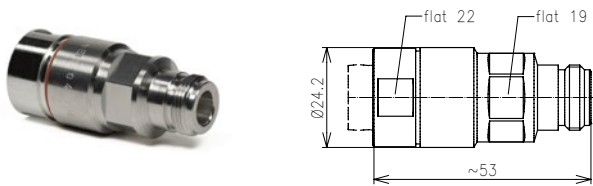

**BN 846417**

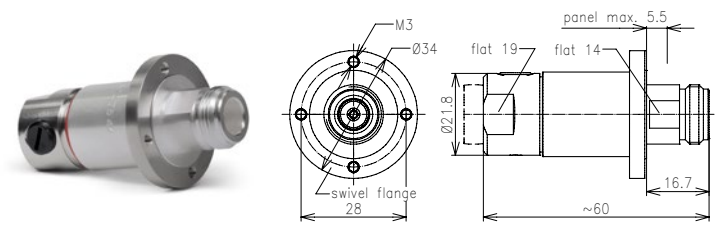

**BN 747544**

## Connectors – Type N

### Cable Connectors for LF 7/8"-50 Cables

Style	Version	Part Number
Male	CAF® Plast2000	<b>BN 706740</b>
Male	CAF® O-ring	<b>BN 706741</b>
Male	MultiFit	<b>BN 706402</b>
Female	CAF® Plast2000	<b>BN 846340</b>
Female	CAF® O-ring	<b>BN 846341</b>
Female	MultiFit	<b>BN 846402</b>

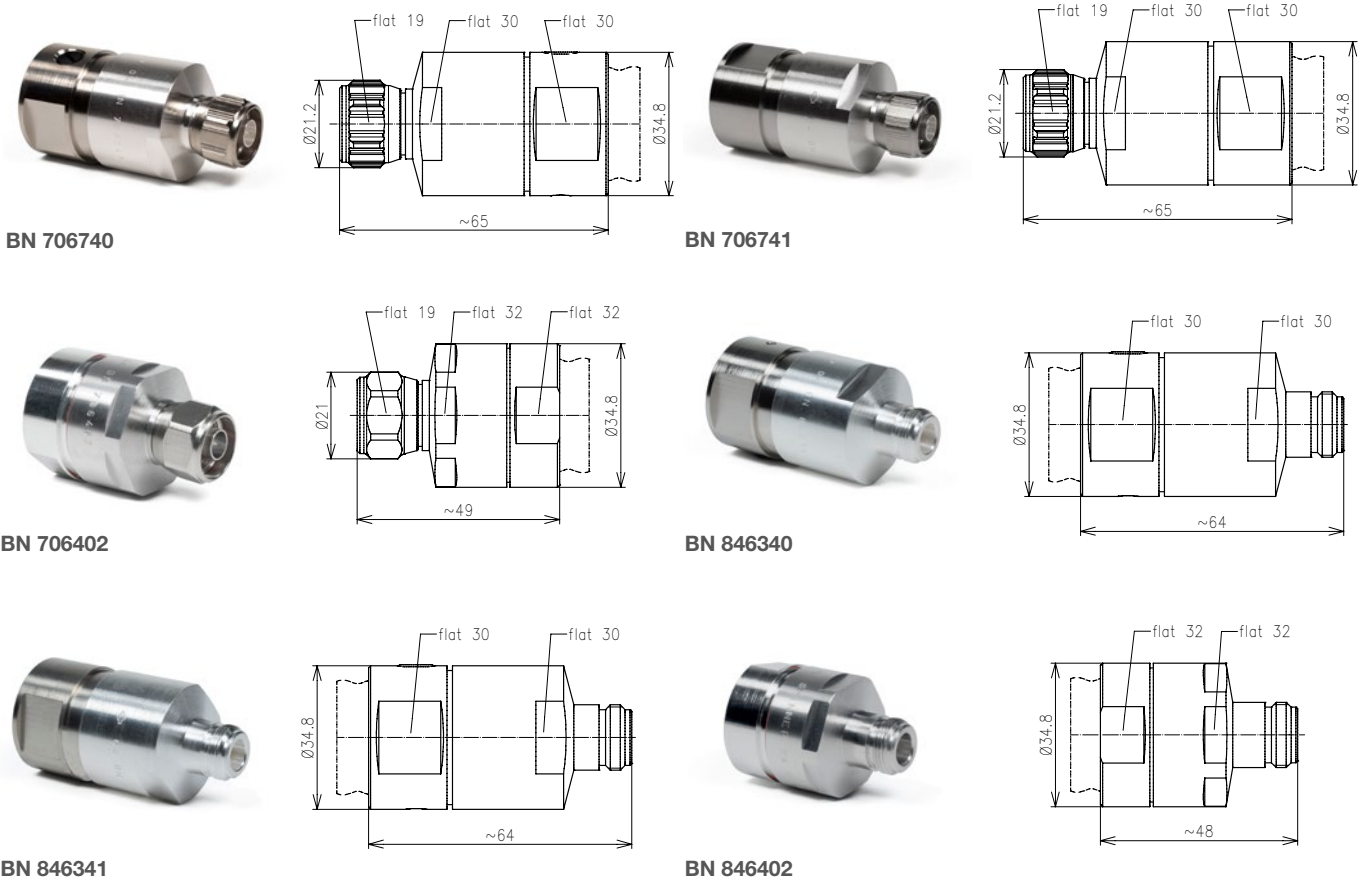

## Connectors – Type N

Cable Connectors for LF 1 1/4"-50 Cables

Style	Version	Part Number
Male	CAF® Plast2000	<b>BN 706742</b>
Male	MultiFit	<b>BN 706420</b>
Female	CAF® Plast2000	<b>BN 846342</b>
Female	MultiFit	<b>BN 846420</b>

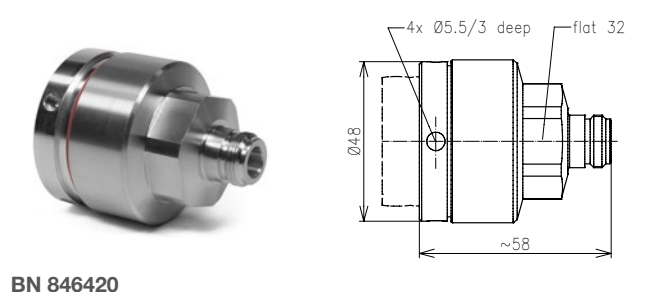
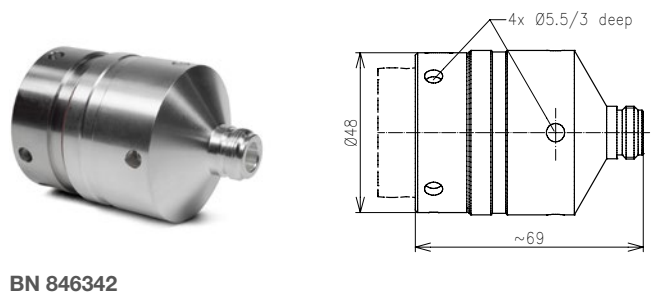
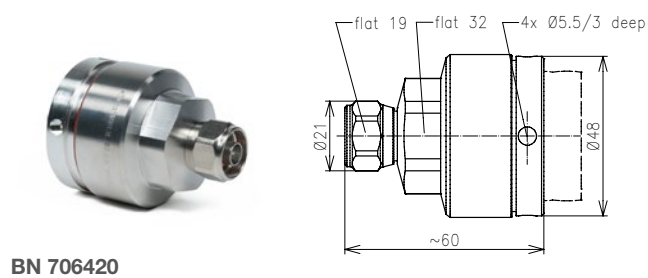
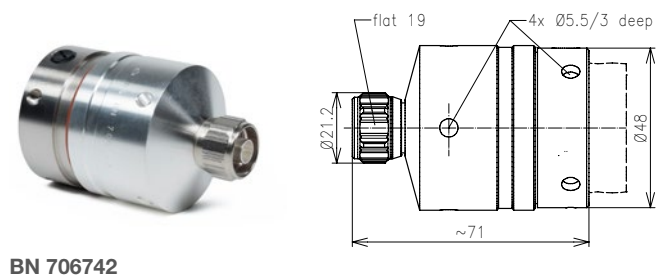

## Connectors – Type N

### Cable Connectors for LF 1 5/8"-50 Cables

Style	Version	Part Number
Male	CAF® Plast2000	<b>BN 706744</b>
Male	MultiFit	<b>BN 706422</b>
Female	CAF® Plast2000	<b>BN 846344</b>
Female	MultiFit	<b>BN 846422</b>

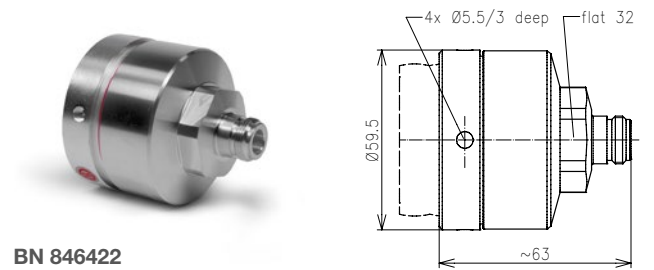
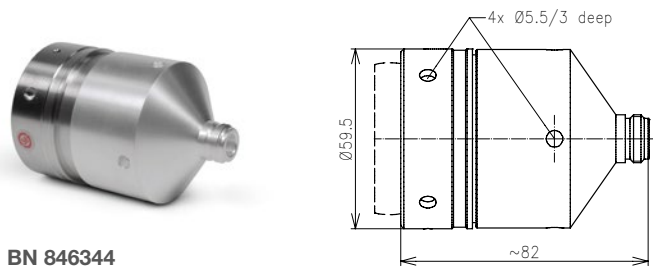
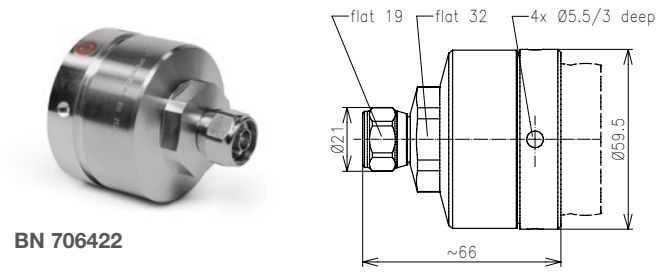
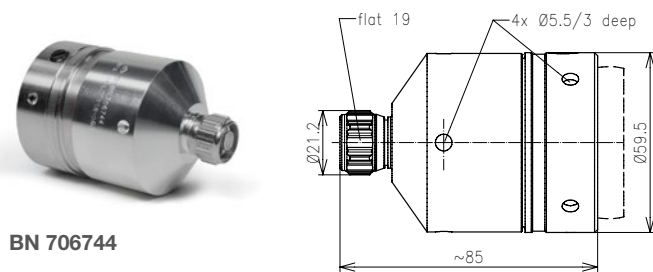

## Connectors – Type N

### Cable Connectors for Radiating Cables

Cable Type	Style	Version	Part Number
RADIAFLEX® 12-50	Male	Heat shrink sleeve	<b>BN 557110</b>
RADIAFLEX® 12-50	Female	Heat shrink sleeve	<b>BN 557111</b>
RADIAFLEX® 78-50	Male	Heat shrink sleeve	<b>BN 557150</b>
RADIAFLEX® 78-50	Female	Heat shrink sleeve	<b>BN 557151</b>
RADIAFLEX® 114-50 A	Female	Heat shrink sleeve	<b>BN 557161</b>
RADIAFLEX® 158-50 A	Female	Heat shrink sleeve	<b>BN 557171</b>

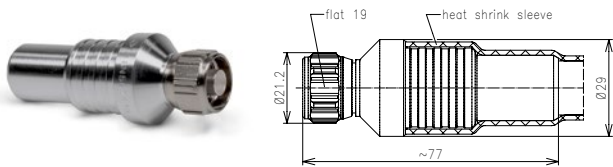

**BN 557110**

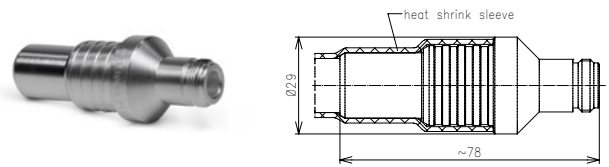

**BN 557111**

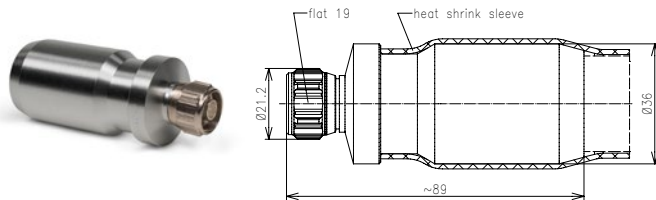

**BN 557150**

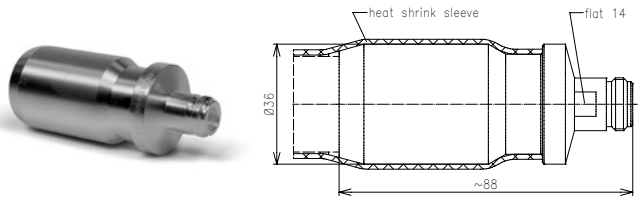

**BN 557151**

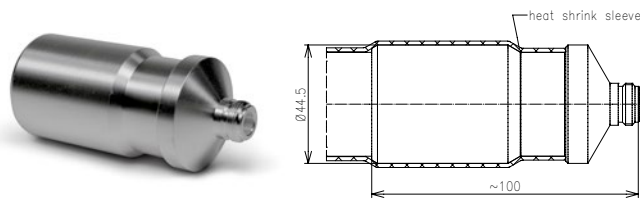

**BN 557161**

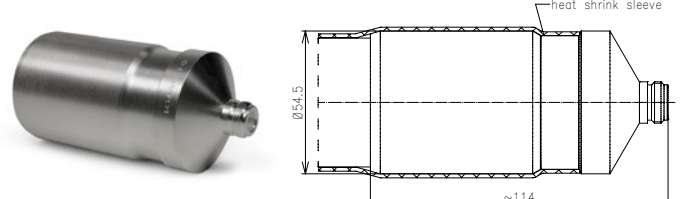

**BN 557171**



## Connectors – Type N

### Cable Connectors for RG Cables

Cable Type	Style	Version	Part Number
RG 58 C/U; RG 142 B/U RG 223/U; RG 400/U	Male	Clamped	<b>BN 296650</b>
RG 58 C/U; RG 142 B/U RG 223/U; RG 400/U	Male, straight and right angle mounting	Clamped	<b>BN 721280</b>
RG 8 related	Male	Clamped	<b>BN 945060</b>
RG 8 related	Male right angle	Clamped	<b>BN 945061</b>
RG 213/U; RG 214/U	Male	Clamped	<b>BN 922450</b>
RG 213/U; RG 214/U	Female	Clamped	<b>BN 922550</b>
RG 214/U; RG 393/U	Male	Crimped	<b>BN 922475</b>
RG 214/U; RG 393/U	Male, straight and right angle mounting	Clamped	<b>BN 721283</b>

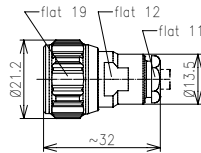

**BN 296650**

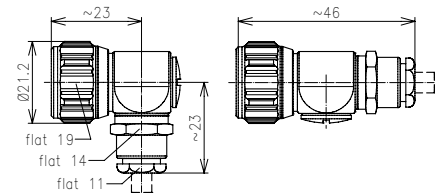

**BN 721280**

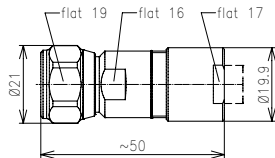

**BN 945060**

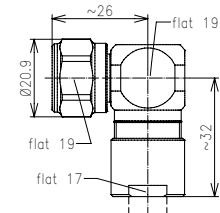

**BN 945061**

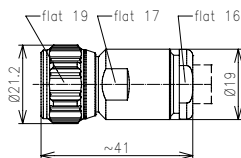

**BN 922450**

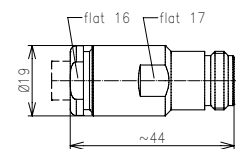

**BN 922550**

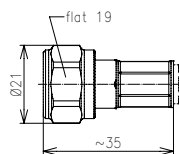

**BN 922475**

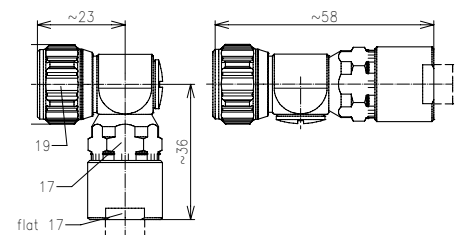

**BN 721283**

## Connectors – Type N

### Connector Head

Style	Part Number
Male, straight and right angle mounting	<b>BN 450940</b>

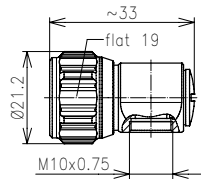

**BN 450940**

### Cable Entries

Cable Type	Version	Part Number
RG 55 B/U RG 58 C/U RG 142 B/U RG 223/U RG 400/U	Clamped	<b>BN 419400</b>
RG 213/U	Clamped	<b>BN 420100</b>
RG 214/U RG 216/U RG 393/U	Clamped	<b>BN 982900</b>
RG 214/U RG 393/U	Crimped	<b>BN 982911</b>

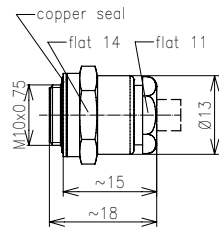

**BN 419400**

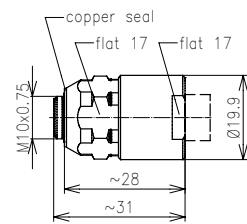

**BN 420100**

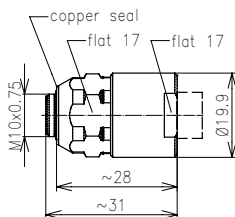

**BN 982900**

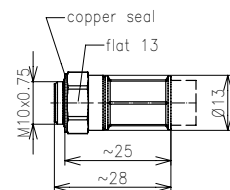

**BN 982911**



## Connectors – Type 2.2-5



2.2-5 is the newest connector system and derived from 4.3-10. When 4.3-10 was launched a few years ago, it was the first connector system to be specifically developed for the mobile communication market. It combines excellent electrical and mechanical properties with relatively compact dimensions. Its developers also focused on ensuring low PIM, and this is one of the main ways in which 4.3-10 excels. With 5G and Small Cells, the miniaturization of mobile communication is ongoing. And it was only a matter of time until an even smaller connector system appeared.

### New But Already Proven

2.2-5 is only half as large as 4.3-10. It is based on the tried-and-true design principles underlying 4.3-10 and ultimately only differs from it in terms of size. Even the available closure versions – screw, hand screw and push-pull – have been adopted from that model. Its IM is an excellent -166 dBc, independently of the tightening torque. Thanks to its smaller dimensions, the 2.2-5 connector system is suitable

for frequencies up to 20 GHz while still being able to transfer more than 200 watts of power. The width of its flange has been reduced from 25.4 to 17.5 mm, which slashes its area by 53%. This connector's compact design makes it ideal for use in leading-edge antennas, remote radio units, MIMO, small cells and other applications that call for superb electrical properties in a minimum of space.

## Connectors – Type 2.2-5

Electrical	IEC 61169-66	Remark
Nominal impedance	50 $\Omega$	
Frequency range	0 - 6 GHz	
Passive intermodulation (IM3) @ 2 x 20 W	$\leq -166$ dBc	0.4 GHz to 4 GHz
VSWR	$\leq 1.05$	Straight connector
Center contact resistance	$\leq 2.0$ m $\Omega$	Initial
Outer contact continuity	1.0 m $\Omega$	Initial
Insulation resistance	3000 M $\Omega$	Initial
Proof voltage at sea level	1.5 kV	50 - 60 Hz
Screening effectiveness	$\geq 100$ dB	Screw type

Mechanical	IEC 61169-66	Remark
Coupling torque	3 Nm	
Tensile strength of coupling mechanism	> 200 N	
Mechanical lifetime	100 Cycles	SPINNER: 500 Cycles

Environmental	IEC 61169-66	Remark
Climatic category	40/85/21	
Degree of protection (mated)		SPINNER: IP 68

Materials and Surface Finish	
Resilient contact parts	High strength copper alloy, silver plated
Insulation	PTFE/FEP
Center and outer conductor parts	Copper alloy, silver plated and/or CuSnZn plated
Other metal parts	Copper alloy, nickel plated and/or tin plated
Gaskets	Silicone rubber

## Connectors – Type 2.2-5

### Cable Connectors for SF 1/4"-50 Cables

Style	Version	Part Number
Male, screw type	CAF®	BN 225040



BN 225040

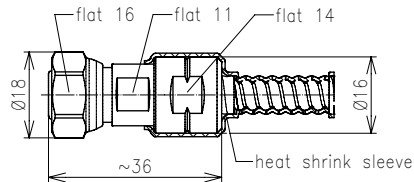

### Cable Connectors for SF 3/8"-50 Cables

Style	Version	Part Number
Male, screw type	CAF®	BN 225038
Male right angle, screw type	CAF®	BN 225039



BN 225038

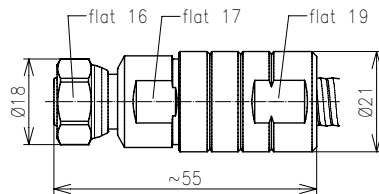

### Cable Connectors for SF 1/2"-50 Cables

Style	Version	Part Number
Male, screw type	MultiFit	BN 225035
Male right angle, screw type	MultiFit	BN 225036



BN 225035

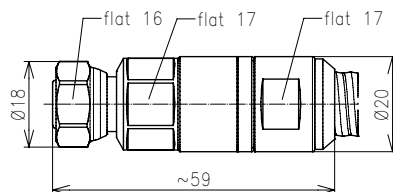

## Connectors – Type 2.2-5

### Fixed Connectors

Cable Type	Style	Version	Part Number
Seriflex 141-50; RG 402/U	Male screw type	Soldered	<b>BN 225027</b>
Seriflex 141-50; RG 402/U	Female bulkhead	Soldered	<b>BN 225046</b>
Seriflex 141-50; RG 402/U	Female four-hole flange	Soldered	<b>BN 225047</b>
Seriflex 250-50; RG 401/U	Male screw type	Soldered	<b>BN 225026</b>
Seriflex 250-50; RG 401/U	Female bulkhead	Soldered	<b>BN 225044</b>
Seriflex 250-50; RG 401/U	Female four-hole flange	Soldered	<b>BN 225045</b>



**BN 225027**

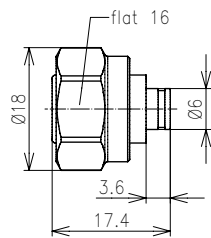

**BN 225047**

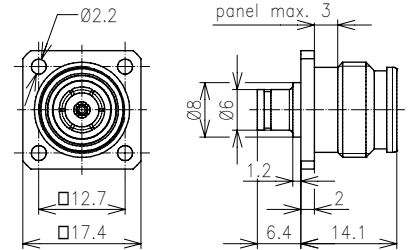

**BN 225026**

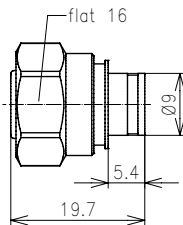

**BN 225045**

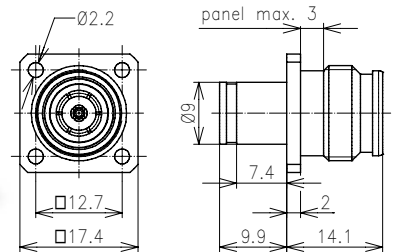

## Adaptors



Adaptors are used to link up one connector type to another. The part numbers listed in this catalogue include the most common and important combinations for mobile communication systems. Further combinations are available upon request.

We specify the items as either male or female in order to describe the connector style. Our adaptors are designed for the lowest possible reflection factors. Precision adaptors with RF quality grade 0 are available upon request.



## Inter-Type Adaptors

### Inter-Type Adaptors 7-16 / 4.3-10

Connector 1	Connector 2	Part Number
7-16 male	4.3-10 male screw type	<b>BN 432005</b>
7-16 male	4.3-10 male hand screw type	<b>BN 432007</b>
7-16 male	4.3-10 male push-pull type	<b>BN 432008</b>
7-16 male	4.3-10 female	<b>BN 432001</b>
7-16 female	4.3-10 male screw type	<b>BN 432002</b>
7-16 female	4.3-10 male hand screw type	<b>BN 432015</b>
7-16 female	4.3-10 male push-pull type	<b>BN 432016</b>
7-16 female	4.3-10 female	<b>BN 432011</b>

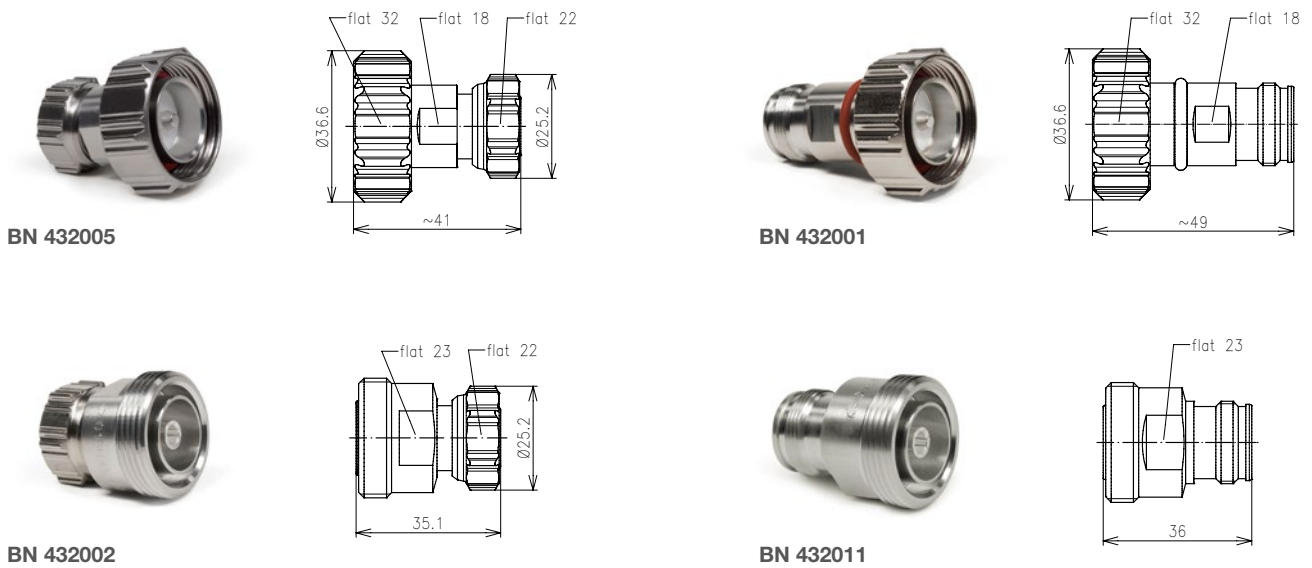

## Inter-Type Adaptors

### Inter-Type Adaptors 7-16 / 4.1-9.5

Connector 1	Connector 2	Part Number
7-16 male	4.1-9.5 male	<b>BN 941510</b>
7-16 male	4.1-9.5 female	<b>BN 941610</b>
7-16 female	4.1-9.5 male	<b>BN 941710</b>
7-16 female	4.1-9.5 female	<b>BN 941810</b>

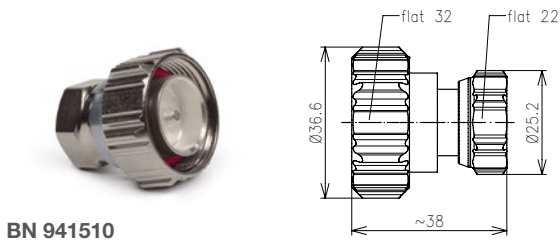

**BN 941510**

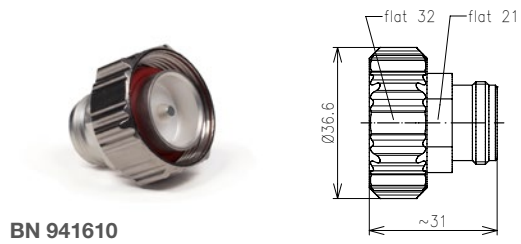

**BN 941610**

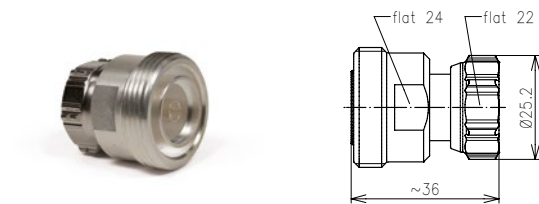

**BN 941710**



**BN 941810**

### Inter-Type Adaptors 7-16 / N

Connector 1	Connector 2	Part Number
7-16 male	N male	<b>BN 293800</b>
7-16 male	N female	<b>BN 194400</b>
7-16 female	N male	<b>BN 293900</b>
7-16 female	N female	<b>BN 294000</b>

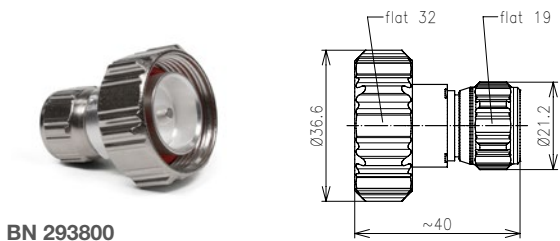

**BN 293800**

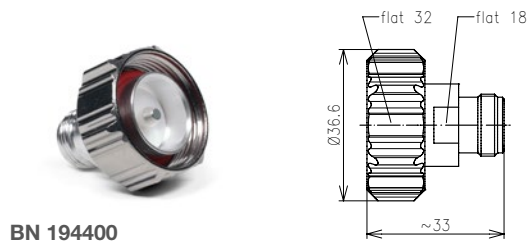

**BN 194400**

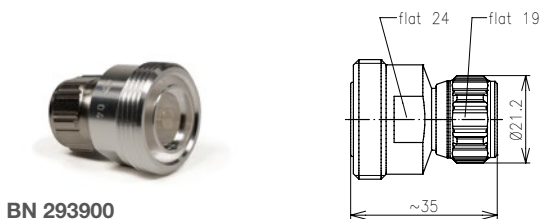

**BN 293900**



**BN 294000**

## Inter-Type Adaptors

### Inter-Type Adaptors 7-16 / 2.2-5

Connector 1	Connector 2	Part Number
7-16 male	2.2-5 male screw type	<b>BN 225002</b>
7-16 male	2.2-5 female	<b>BN 225003</b>
7-16 female	2.2-5 male screw type	<b>BN 225006</b>
7-16 female	2.2-5 female	<b>BN 225008</b>

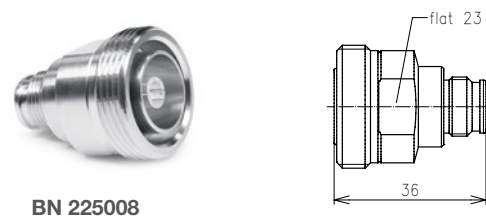
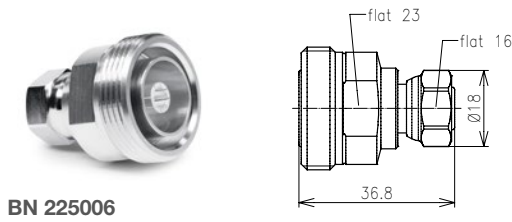
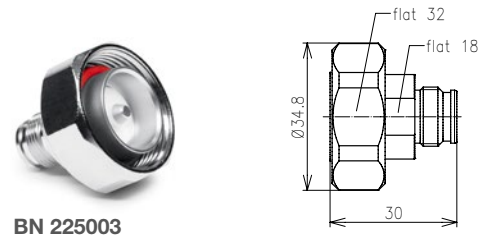
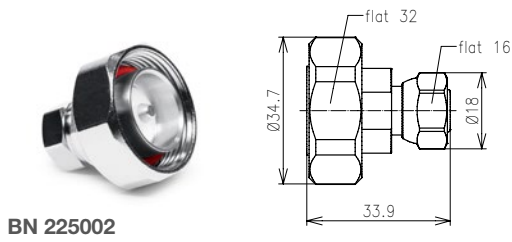

## Inter-Type Adaptors

### Inter-Type Adaptors 4.3-10 / N

Connector 1	Connector 2	Part Number
4.3-10 male screw type	N male	<b>BN 432024</b>
4.3-10 male hand screw type	N male	<b>BN 432009</b>
4.3-10 male push-pull type	N male	<b>BN 432030</b>
4.3-10 male screw type	N female	<b>BN 432025</b>
4.3-10 male hand screw type	N female	<b>BN 432003</b>
4.3-10 male push-pull type	N female	<b>BN 432031</b>
4.3-10 female	N male	<b>BN 432004</b>
4.3-10 female	N female	<b>BN 432010</b>

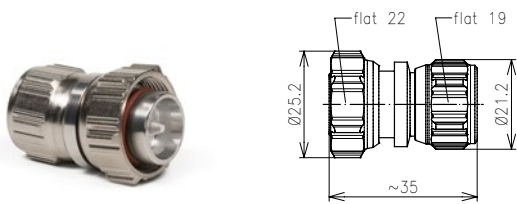

**BN 432024**

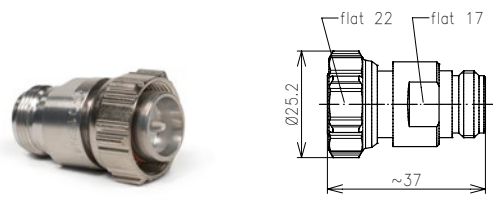

**BN 432025**

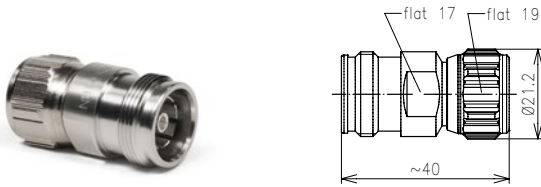

**BN 432004**

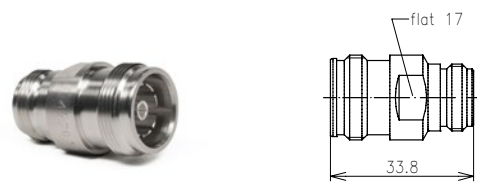

**BN 432010**

## Inter-Type Adaptors

### Inter-Type Adaptors 4.3-10 / 2.2-5

Connector 1	Connector 2	Part Number
4.3-10 male screw type	2.2-5 male screw type	<b>BN 225009</b>
4.3-10 male screw type	2.2-5 female	<b>BN 225010</b>
4.3-10 female	2.2-5 male screw type	<b>BN 225012</b>
4.3-10 female	2.2-5 female	<b>BN 225013</b>



**BN 225009**

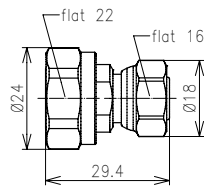

**BN 225010**

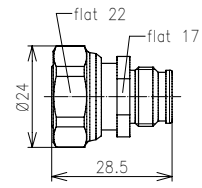

**BN 225012**

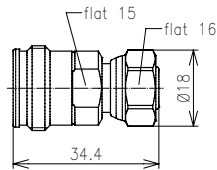

**BN 225013**

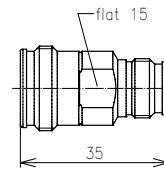

## Inter-Type Adaptors

### Inter-Type Adaptors 4.3-10 / 3.5 mm

Connector 1	Connector 2	Part Number
4.3-10 male screw type	3.5 mm male	<b>BN 432026</b>
4.3-10 male hand screw type	3.5 mm male	<b>BN 432020</b>
4.3-10 male push-pull type	3.5 mm male	<b>BN 432032</b>
4.3-10 male screw type	3.5 mm female	<b>BN 432027</b>
4.3-10 male hand screw type	3.5 mm female	<b>BN 432021</b>
4.3-10 male push-pull type	3.5 mm female	<b>BN 432033</b>
4.3-10 female	3.5 mm male	<b>BN 432022</b>
4.3-10 female	3.5 mm female	<b>BN 432023</b>

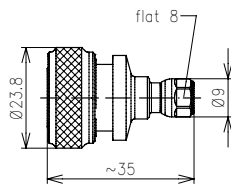

**BN 432020**

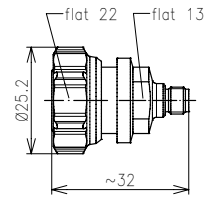

**BN 432027**

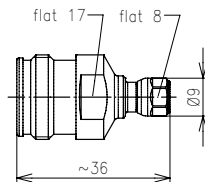

**BN 432022**

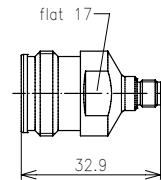

**BN 432023**

## Inter-Type Adaptors

### Inter-Type Adaptors 4.1-9.5 / N

Connector 1	Connector 2	Part Number
4.1-9.5 male	N male	<b>BN 955450</b>
4.1-9.5 male	N female	<b>BN 955250</b>
4.1-9.5 female	N male	<b>BN 955550</b>
4.1-9.5 female	N female	<b>BN 955350</b>

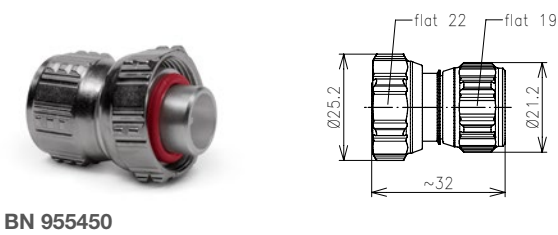

**BN 955450**

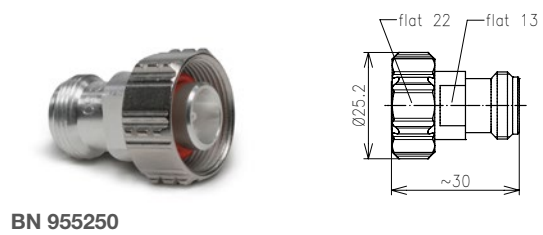

**BN 955250**

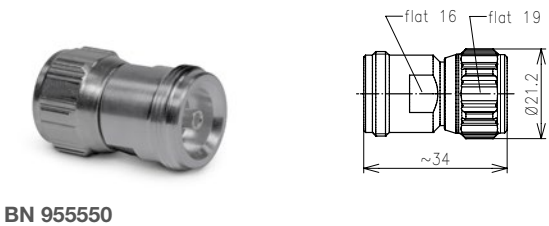

**BN 955550**



**BN 955350**

### Inter-Type Adaptors N / 2.2-5

Connector 1	Connector 2	Part Number
N male	2.2-5 male screw type	<b>BN 225014</b>
N male	2.2-5 female	<b>BN 225015</b>
N female	2.2-5 male screw type	<b>BN 225016</b>
N female	2.2-5 female	<b>BN 225017</b>

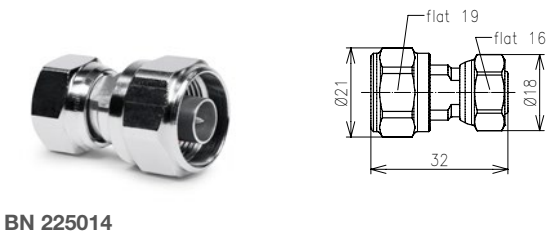

**BN 225014**

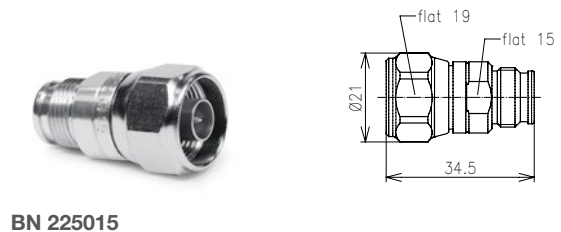

**BN 225015**



**BN 225016**



**BN 225017**

## Inter-Type Adaptors

### Inter-Type Adaptors N / 3.5 mm

Connector 1	Connector 2	Part Number
N male	3.5 mm male	<b>BN 640681</b>
N male	3.5 mm female	<b>BN 640683</b>
N female	3.5 mm male	<b>BN 640682</b>
N female	3.5 mm female	<b>BN 640680</b>

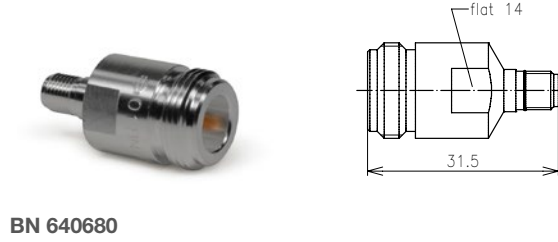
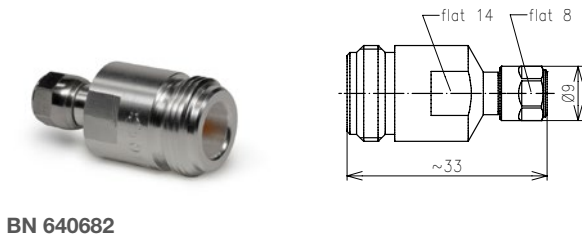
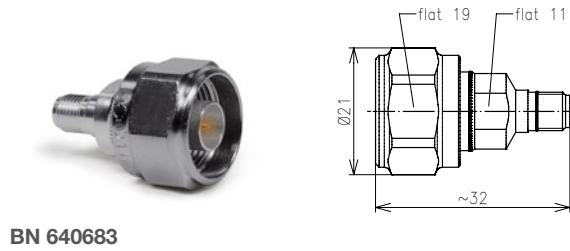
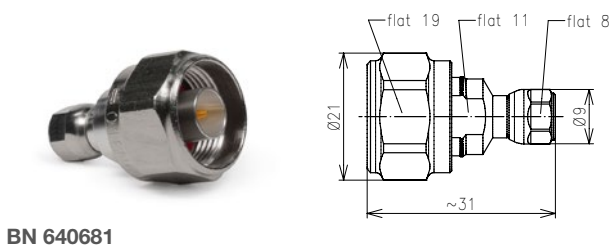



## Within-Type Adaptors

### 7-16 Within-Type Adaptors

Connector 1	Connector 2	Part Number
7-16 male	7-16 male	<b>BN 393370</b>
7-16 male right angle	7-16 male	<b>BN 944702</b>
7-16 male	7-16 female	<b>BN 756404</b>
7-16 male right angle	7-16 female	<b>BN 296400</b>
7-16 female	7-16 female	<b>BN 196400</b>
7-16 female four-hole flange	7-16 female	<b>BN 808450</b>

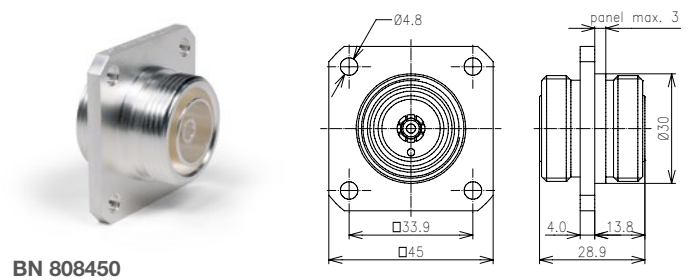
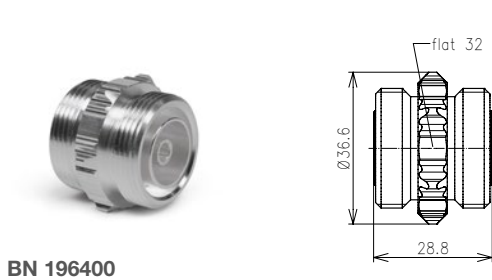
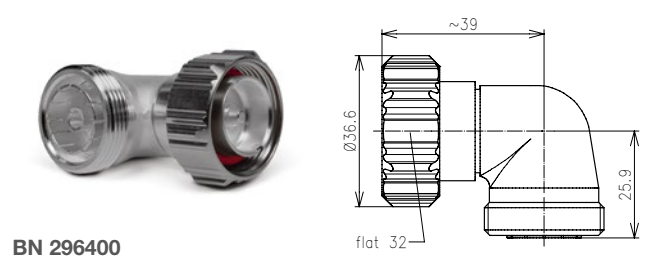
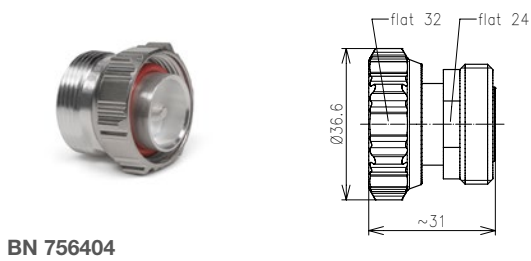
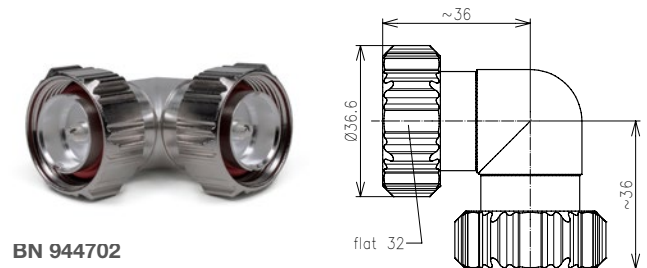
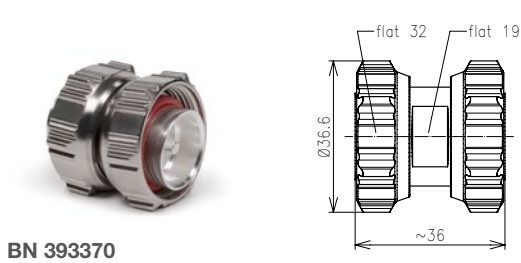

## Within-Type Adaptors

### 4.3-10 Within-Type Adaptors

Connector 1	Connector 2	Part Number
4.3-10 male screw type	4.3-10 male screw type	<b>BN 432029</b>
4.3-10 male hand screw type	4.3-10 male hand screw type	<b>BN 432018</b>
4.3-10 male push-pull type	4.3-10 male push-pull type	<b>BN 432035</b>
4.3-10 male screw type	4.3-10 female	<b>BN 432017</b>
4.3-10 male hand screw type	4.3-10 female	<b>BN 432028</b>
4.3-10 male push-pull type	4.3-10 female	<b>BN 432034</b>
4.3-10 male right angle screw type	4.3-10 female	<b>BN 432055</b>
4.3-10 female	4.3-10 female	<b>BN 432049</b>
4.3-10 female four-hole flange	4.3-10 female	<b>BN 432050</b>
4.3-10 female bulkhead	4.3-10 female	<b>BN 432019</b>

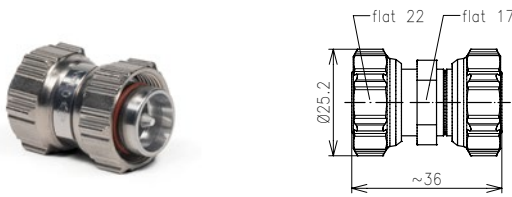

**BN 432029**

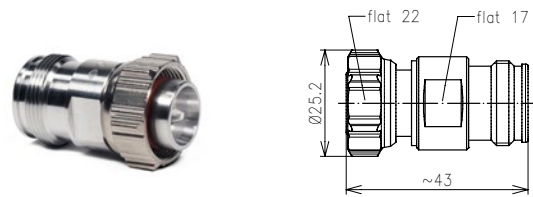

**BN 432017**

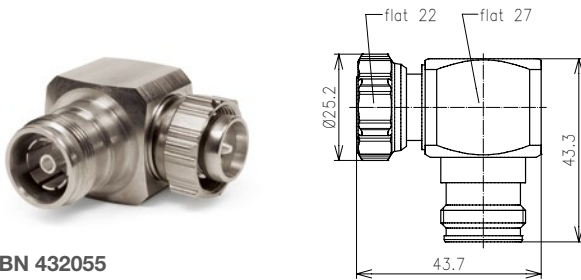

**BN 432055**

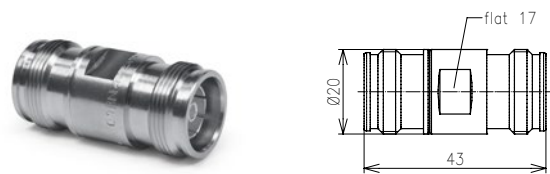

**BN 432049**

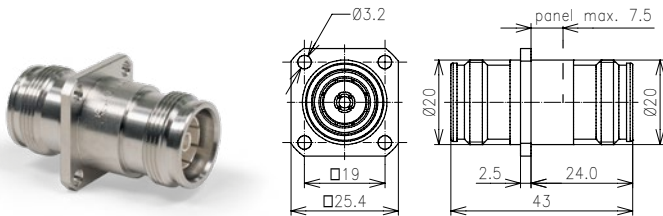

**BN 432050**

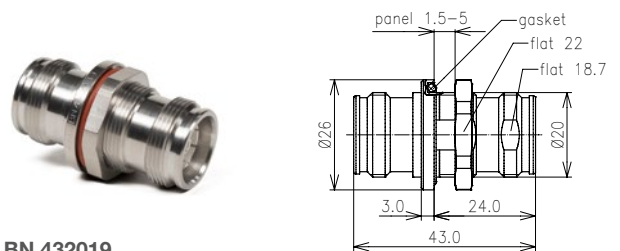

**BN 432019**

## Within-Type Adaptors

### N Within-Type Adaptors

Connector 1	Connector 2	Part Number
N male	N male	<b>BN 293650</b>
N male right angle	N male	<b>BN 708250</b>
N male	N female	<b>BN 950890</b>
N male right angle	N female	<b>BN 299750</b>
N female	N female	<b>BN 293750</b>
N female four-hole flange	N female	<b>BN 944951</b>
N female bulkhead	N female	<b>BN 944950</b>

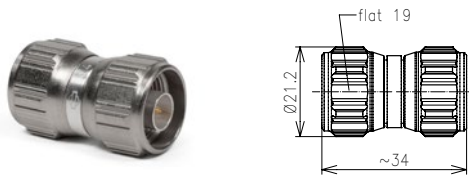

**BN 293650**

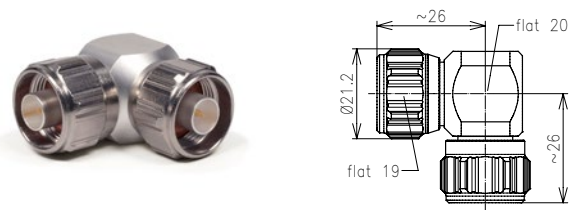

**BN 708250**

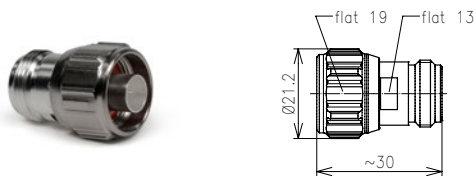

**BN 950890**

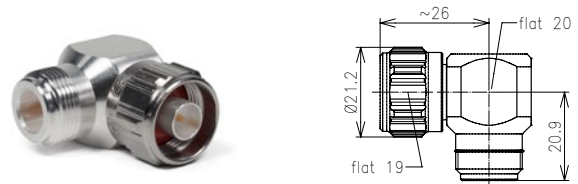

**BN 299750**



**BN 293750**

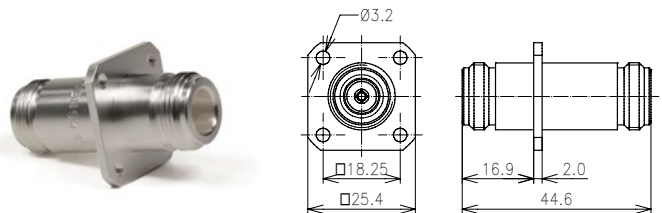

**BN 944951**

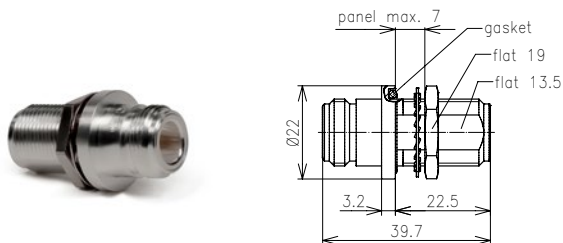

**BN 944950**

## Within-Type Adaptors

### Within-Type Adaptors 2.2-5 / 2.2-5

Connector 1	Connector 2	Part Number
2.2-5 male screw type	2.2-5 male screw type	<b>BN 225018</b>
2.2-5 male screw type	2.2-5 female	<b>BN 225019</b>
2.2-5 female bulkhead	2.2-5 female	<b>BN 225020</b>
2.2-5 male right angle screw type	2.2-5 female	<b>BN 225021</b>

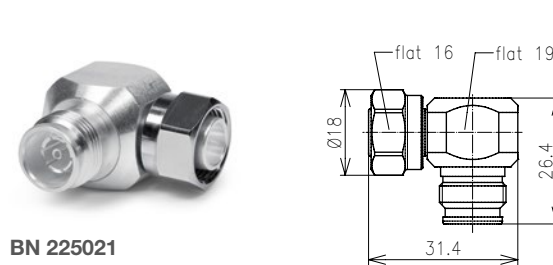
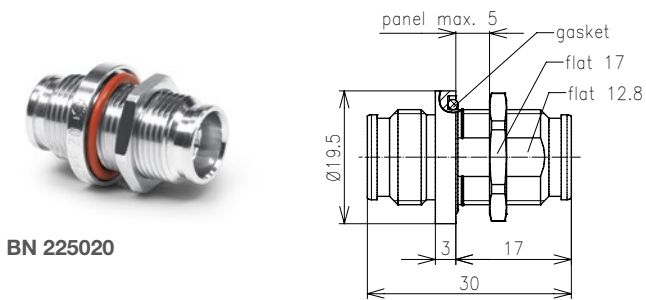
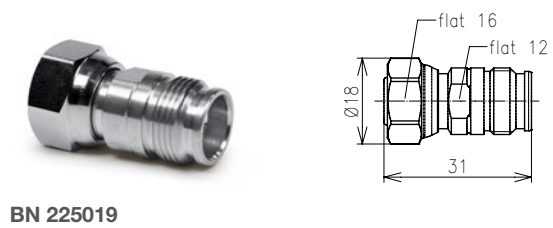
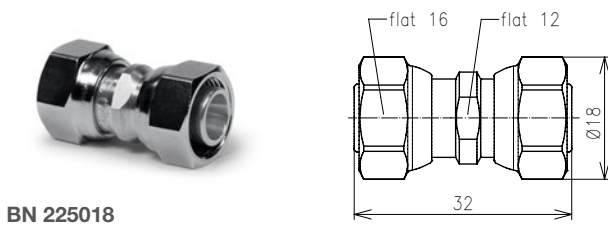



## Jumper Cable Assemblies



**SPINNER has long standing experience in manufacturing top-notch jumper cable assemblies for mobile communication. Our fully automated and permanently optimized manufacturing processes ensure excellent quality, competitive prices and short lead times.**

Our high quality standards with regards to design, material and manufacturing ensure best possible connectivity between base stations and antennas, optimized installation and failure-free operation, even under toughest conditions.

We guarantee superior IM properties and low VSWR values over the entire lifetime of the cables. **The benefits are obvious: lower total cost of ownership.**

Jumpers can be manufactured based on your individual requirements for length and connector types. We also fulfill special requirements such as measurement or phase adjusted cables, jumpers with grey jacket or specified to meet fire retardant requirements.

## Portfolio Overview

### SpinnerFlex® TopFit jumpers



The classic jumpers

### SpinnerFlex® MultiFit jumpers



SF1/2"-50 jumpers with integrated MultiFit 7/8" feeder cable clamp

### SpinnerFlex® Hybrid jumpers



Factory assembled jumper-feeder-jumper combination

### SPINNER Seriflex



Tailored cable for further processing

## Jumper Cables – SpinnerFlex® TopFit

SpinnerFlex® TopFit – SF 1/2"-50



SpinnerFlex® TopFit jumpers based on SF 1/2" cable are available with 7-16, 4.3-10, 4.1-9.5, N and 2.2-5 connectors.

For ordering please use article codes on 67.

Electrical Specification					
Passive intermodulation (IM3) @ 2 x 20 W	≤ -160 dBc; typ. ≤ -165 dBc Jumpers with improved IM3 values on request				
Frequency ranges	≤ 960 MHz	≤ 2200 MHz	≤ 2700 MHz	≤ 3800 MHz	≤ 5825 MHz
Typ. VSWR for lengths ≤ 6 m					
2 straight connectors	≤ 1.03	≤ 1.05	≤ 1.06	≤ 1.10	≤ 1.14
1 straight, 1 right angle connector	≤ 1.04	≤ 1.06	≤ 1.07	≤ 1.11	≤ 1.16
2 right angle connectors	≤ 1.05	≤ 1.07	≤ 1.08	≤ 1.12	≤ 1.18
Typ. VSWR for lengths > 6 m					
2 straight connectors	≤ 1.04	≤ 1.06	≤ 1.07	≤ 1.11	≤ 1.15
1 straight, 1 right angle connector	≤ 1.05	≤ 1.07	≤ 1.08	≤ 1.12	≤ 1.17
2 right angle connectors	≤ 1.06	≤ 1.08	≤ 1.09	≤ 1.13	≤ 1.19
Insertion loss / 100 m	≤ 11.56 dB	≤ 18.64 dB	≤ 21.06 dB	≤ 25.90 dB	≤ 33.79 dB
Power rating @ 40 °C	≤ 0.91 kW	≤ 0.56 kW	≤ 0.49 kW	≤ 0.42 kW	≤ 0.31 kW

## Jumper Cables – SpinnerFlex® TopFit

SpinnerFlex® TopFit – SF 3/8"-50



SpinnerFlex® TopFit jumpers based on SF 3/8" cable are available with 7-16, 4.3-10, 4.1-9.5, N and 2.2-5 connectors.

For ordering please use article codes on 67.

Electrical Specification					
Passive intermodulation (IM3) @ 2 x 20 W	≤ -160 dBc; typ. ≤ -165 dBc Jumpers with improved IM3 values on request				
Frequency ranges	≤ 960 MHz	≤ 2200 MHz	≤ 2700 MHz	≤ 3800 MHz	≤ 5825 MHz
Typ. VSWR for lengths ≤ 6 m					
2 straight connectors	≤ 1.03	≤ 1.05	≤ 1.06	≤ 1.10	≤ 1.14
1 straight, 1 right angle connector	≤ 1.04	≤ 1.06	≤ 1.07	≤ 1.11	≤ 1.16
2 right angle connectors	≤ 1.05	≤ 1.07	≤ 1.08	≤ 1.12	≤ 1.18
Typ. VSWR for lengths > 6 m					
2 straight connectors	≤ 1.04	≤ 1.06	≤ 1.07	≤ 1.11	≤ 1.15
1 straight, 1 right angle connector	≤ 1.05	≤ 1.07	≤ 1.08	≤ 1.12	≤ 1.17
2 right angle connectors	≤ 1.06	≤ 1.08	≤ 1.09	≤ 1.13	≤ 1.19
Insertion loss / 100 m	≤ 13.8 dB	≤ 21.7 dB	≤ 25.8 dB	≤ 30.4 dB	≤ 38.4 dB
Power rating @ 40 °C	≤ 0.57 kW	≤ 0.36 kW	≤ 0.31 kW	≤ 0.26 kW	≤ 0.20 kW



## Jumper Cables – SpinnerFlex® TopFit

SpinnerFlex® TopFit – SF 1/4"-50



SpinnerFlex® TopFit jumpers based on SF 1/4" cable are available with 7-16, 4.3-10, 4.1-9.5, N and 2.2-5 connectors.

For ordering please use article codes on 67.

Electrical Specification					
Passive intermodulation (IM3) @ 2 x 20 W	≤ -156 dBc; typ. ≤ -160 dBc Jumpers with improved IM3 values on request				
Frequency ranges	≤ 960 MHz	≤ 2200 MHz	≤ 2700 MHz	≤ 3800 MHz	≤ 5825 MHz
Typ. VSWR for lengths ≤ 6 m					
2 straight connectors	≤ 1.03	≤ 1.05	≤ 1.06	≤ 1.10	≤ 1.14
1 straight, 1 right angle connector	≤ 1.04	≤ 1.06	≤ 1.07	≤ 1.11	≤ 1.16
2 right angle connectors	≤ 1.05	≤ 1.07	≤ 1.08	≤ 1.12	≤ 1.18
Typ. VSWR for lengths > 6 m					
2 straight connectors	≤ 1.04	≤ 1.06	≤ 1.07	≤ 1.11	≤ 1.15
1 straight, 1 right angle connector	≤ 1.05	≤ 1.07	≤ 1.08	≤ 1.12	≤ 1.17
2 right angle connectors	≤ 1.06	≤ 1.08	≤ 1.09	≤ 1.13	≤ 1.19
Insertion loss / 100 m	≤ 19.1 dB	≤ 30.1 dB	≤ 33.7 dB	≤ 40.4 dB	≤ 53.4 dB
Power rating @ 40 °C	≤ 0.35 kW	≤ 0.22 kW	≤ 0.19 kW	≤ 0.16 kW	≤ 0.12 kW

## Jumper Cables – SpinnerFlex® TopFit

SpinnerFlex® TopFit – LF 1/2"-50



SpinnerFlex® TopFit jumpers based on LF 1/2" cable are available with 7-16, 4.3-10, 4.1-9.5, N and 2.2-5 connectors.

For ordering please use article codes on 67.

Electrical Specification					
Passive intermodulation (IM3) @ 2 x 20 W	≤ -156 dBc; typ. ≤ -165 dBc Jumpers with improved IM3 values on request				
Frequency ranges	≤ 960 MHz	≤ 2200 MHz	≤ 2700 MHz	≤ 3800 MHz	≤ 5825 MHz
Typ. VSWR for lengths ≤ 6 m					
2 straight connectors	≤ 1.03	≤ 1.05	≤ 1.06	≤ 1.10	≤ 1.14
1 straight, 1 right angle connector	≤ 1.04	≤ 1.06	≤ 1.07	≤ 1.11	≤ 1.16
2 right angle connectors	≤ 1.05	≤ 1.07	≤ 1.08	≤ 1.12	≤ 1.18
Typ. VSWR for lengths > 6 m					
2 straight connectors	≤ 1.04	≤ 1.06	≤ 1.07	≤ 1.11	≤ 1.15
1 straight, 1 right angle connector	≤ 1.05	≤ 1.07	≤ 1.08	≤ 1.12	≤ 1.17
2 right angle connectors	≤ 1.06	≤ 1.08	≤ 1.09	≤ 1.13	≤ 1.19
Insertion loss / 100 m	≤ 7.12 dB	≤ 11.25 dB	≤ 12.63 dB	≤ 15.36 dB	≤ 19.71 dB
Power rating @ 40 °C	≤ 1.06 kW	≤ 0.67 kW	≤ 0.59 kW	≤ 0.50 kW	≤ 0.38 kW



## Jumper Cables – SpinnerFlex® TopFit Article Codes

Please use article codes for inquiries and orders.

These are self explaining and enable you to specify a product without knowing its part number.

Jumper	Cable Type	Cable Size	Cable Jacket	Connector 1	Connector 2	Length	Unit	Length	Extra Features		
<b>J</b>	<b>Z</b>	<b>X</b>	<b>Z</b>	<b>-</b>	<b>XZ</b>	<b>XZ</b>	<b>-</b>	<b>X</b>	<b>Z</b>	<b>X</b>	<b>-Z</b>
LF	L		Blank for PE	Any combination of connectors below is possible.							Leave blank if not applicable
SF	S			Please specify an XZ combination for connectors 1 and 2.							
1/4"		14		In case of pigtail leave blank for connector 2							
3/8"		38									
1/2"		12									
Fire retardant			F								
Construction Products Regulation (CPR)			C								
Gray			G								
X =	Z =			X	Z						
Connector System	Connector Style										
7-16	Male			7	M						
4.1-9.5	Male right angle			41	R						
N	Female (right angle)			N	F(R)						
	Female bulkhead (right angle)				B(R)						
	Female four-hole panel (right angle)				P(R)						
4.3-10	Male; screw			43	MS						
2.2-5	Male; hand screw			22	MH						
NEX10®	Male; push-pull			X	MP						
	Male right angle; screw				RS						
	Male right angle; hand screw				RH						
	Male right angle; push-pull				RP						
	Female (right angle)				F(R)						
	Female bulkhead (right angle)				B(R)						
	Female four-hole panel (right angle)				P(R)						
Length in meters/feet (depending on unit specified)											
Meters as unit										M	
Feet as unit										F	
Length in decimeters/inches (depending on unit specified)											
Low PIM Measurement Cable (only available with PE jacket)											
- Passive intermodulation (IM3) @ 2 x 20 W ≤ -160 dBc <sup>1)</sup> , inspection certificate 3.1 <sup>2)</sup> , per jumper											I0
- Passive intermodulation (IM3) @ 2 x 20 W ≤ -160 dBc <sup>1)</sup> , inspection certificate 3.1 <sup>2)</sup> , per order											I1
- Passive intermodulation (IM3) @ 2 x 20 W ≤ -165 dBc <sup>1)</sup> , inspection certificate 3.1 <sup>2)</sup> , per jumper											I2
- Passive intermodulation (IM3) @ 2 x 20 W ≤ -165 dBc <sup>1)</sup> , inspection certificate 3.1 <sup>2)</sup> , per order											I3
- Passive intermodulation (IM3) @ 2 x 20 W ≤ -170 dBc <sup>1)</sup> , inspection certificate 3.1 <sup>2)</sup> , per jumper											I4
- Passive intermodulation (IM3) @ 2 x 20 W ≤ -170 dBc <sup>1)</sup> , inspection certificate 3.1 <sup>2)</sup> , per order											I5
Defined phase length											P
Extended frequency range (> 3800 MHz)											E
Connector specified on side B kitted to the jumper											K
Jumper set											S

<sup>1)</sup> According to IEC 62037-2 and WN 20 000

<sup>2)</sup> According to EN 10204

**Examples of article codes:**

**JS12-7M43RS-2M5:** 2.5-meter-long SF 1/2" jumper with 7-16 male and 4.3-10 male right-angle screw type connectors.

**JS38C-43MS43MS-6M:** 6-meter-long CPR-compliant SF 3/8" jumper with 4.3-10 male screw type connectors.

## Jumper Cables – SpinnerFlex® MultiFit

SpinnerFlex® MultiFit – SF 1/2"-50



SpinnerFlex® MultiFit jumpers are based on SF 1/2" jumper cable. On one end fits a LF 7/8" feeder connector/cable clamp, the other end can be fitted with 7-16, 4.3-10, 4.1-9.5, N or 2.2-5 connectors.

For ordering please use article codes on page 69.

Electrical Specification				
Passive intermodulation (IM3) @ 2 x 20 W	≤ -156 dBc; typ. ≤ -165 dBc Jumpers with improved IM3 values on request			
Frequency ranges	≤ 960 MHz	≤ 2200 MHz	≤ 2700 MHz	≤ 3800 MHz
Typ. VSWR for lengths ≤ 6 m				
Straight connector	≤ 1.03	≤ 1.05	≤ 1.06	≤ 1.10
Right angle connector	≤ 1.04	≤ 1.06	≤ 1.07	≤ 1.11
Typ. VSWR for lengths > 6 m				
Straight connector	≤ 1.04	≤ 1.06	≤ 1.07	≤ 1.11
Right angle connector	≤ 1.05	≤ 1.07	≤ 1.08	≤ 1.12
Insertion loss / 100 m	≤ 11.56 dB	≤ 18.64 dB	≤ 21.06 dB	≤ 25.90 dB
Power rating @ 40 °C	≤ 0.91 kW	≤ 0.56 kW	≤ 0.49 kW	≤ 0.42 kW



## Jumper Cables – SpinnerFlex® MultiFit Article Codes

Please use article codes for inquiries and orders.

These are self explaining and enable you to specify a product without knowing its part number.

Jumper MultiFit	Cable Type	Cable Size	Cable Jacket	Connector	Feeder Connection	Length	Unit	Length			
JM	S	12	Z	-	XZ	L78	-	X	Z	X	
		Currently only SF 1/2" available	Blank for PE	Please specify XZ combination for connector	Currently only LF 7/8" available						
Fire retardant			F								
Construction Products Regulation (CPR)			C								
Gray			G								
X = Connector system		Z = Connector style		X	Z						
7-16		Male		7	M						
4.1-9.5		Male right angle		41	R						
N		Female (right angle)		N	F(R)						
		Female bulkhead (right angle)			B(R)						
		Female four-hole flange (right angle)			P(R)						
4.3-10		Male; screw		43	MS						
2.2-5		Male; hand screw		22	MH						
		Male; push-pull			MP						
		Male right angle; screw			RS						
		Male right angle; hand screw			RH						
		Male right angle; push-pull			RP						
		Female (right angle)			F(R)						
		Female bulkhead (right angle)			B(R)						
		Female four-hole flange (right angle)			P(R)						
Length in meters/feet (max. length from 0.5 m - 3 m/3 ft. - 10 ft., depending on unit specified)											
Meters									M		
Feet									F		
Length in decimeters/inch (depending on unit specified)											

**Examples of article codes:**

**JMS12-43MSL78-1M5:** 1.5-meter-long SF 1/2" jumper with 4.3-10 male screw type and assemble to feeder LF 7/8".

## Jumper Cables – SpinnerFlex® Hybrid

SpinnerFlex® TopFit – LF 1/2"-50



The SpinnerFlex® Hybrid jumpers are based on SF 1/2" and LF 7/8" cable and available with 7-16, 4.3-10, 4.1-9.5, N or 2.2-5 connectors. Total length is between 6 and 20 meters, the SF 1/2" jumper part is one meter on each side. Other versions can be made available on request.

For ordering please use article codes on page 71.

Electrical Specification					
Passive intermodulation (IM3) @ 2 x 20 W		≤ -160 dBc; typ. ≤ -165 dBc Jumpers with improved IM3 values on request			
Frequency ranges		≤ 960 MHz	≤ 2200 MHz	≤ 2700 MHz	≤ 3800 MHz
Typ. VSWR		≤ 1.06	≤ 1.08	≤ 1.09	≤ 1.16
Insertion loss		Jumper SF 1/2" Feeder LF 7/8"		≤ 11.56 dB/100m ≤ 4.02 dB/100m	≤ 18.64 dB/100m ≤ 6.46 dB/100m
Power rating @ 40 °C		≤ 0.91 kW	≤ 0.56 kW	≤ 0.49 kW	≤ 0.35 kW



## Jumper Cables – SpinnerFlex® Hybrid Jumper Article Codes

Please use article codes for inquiries and orders.

These are self explaining and enable you to specify a product without knowing its part number.

Jumper	Hybrid	Cable Jacket		Connector 1	Connector 2		Length	Unit	Length	
J	H	Z	-	XZ	XZ	-	X	Z	X	
		Blank for PE	Any combination of connectors below is possible. Please specify an XZ combination for connectors 1 and 2.							
SF 1/2"+LF 7/8"+SF 1/2"										
Fire retardant Construction Products Regulation (CPR)		F C								
X = Connector system		Z = Connector style								
7-16	7	Male		M						
4.1-9.5	41	Male right angle		R						
N	N	Female (right angle)		F(R)						
		Female bulkhead (right angle)		B(R)						
		Female four-hole flange (right angle)		P(R)						
4.3-10	43	Male; screw		MS						
2.2-5	22	Male; hand screw		MH						
		Male; push-pull		MP						
		Male right angle; screw		RS						
		Male right angle; hand screw		RH						
		Male right angle; push-pull		RP						
		Female (right angle)		F(R)						
		Female bulkhead (right angle)		B(R)						
		Female four-hole flange (right angle)		P(R)						
Total length in meters/feet (depending on unit specified; please consider fix length for each SF1/2" end is 1 m by default and included in total length)										
Meters								M		
Feet								F		
Length in decimeters/inch (depending on unit specified)										

**Example of article codes:**

**JH-7M43RS-6M:** Hybrid jumper with 7-16 male and 4.3-10 male right angle screw type; length of 6 meters; 2x jumper SF 1/2" 1 meter each and feeder LF 7/8" with 4 meters.

## SpinnerFlex® Cable

In-Building and other installation projects often call for cables that are cut to length and terminated on site. SPINNER lets you order the most popular cable types on reels and have them sent straight to where they will be used.

All SPINNER CAF® and SPINNER MultiFit® connectors can of course be attached to our cables to ensure the best possible connections for your applications.

Cable Type	Jacket (Fire Class)	Diameter over Jacket	Min. Bending Radius Repeated Bends	Attenuation @ 960 MHz / 100 m	Power Rating @ 960 MHz	Part Number
SF 1/2"-50-PE	PE (F <sub>ca</sub> )	13.5 mm	30 mm	≤ 11.56 dB	≤ 0.91 kW	<b>A73151</b> *
SF 1/2"-50-CPR	CPR (B2 <sub>ca</sub> )	13.5 mm	30 mm	≤ 11.56 dB	≤ 0.91 kW	<b>A73030</b> *
LF 1/2"-50-PE	PE (F <sub>ca</sub> )	15.8 mm	125 mm	≤ 7.12 dB	≤ 1.06 kW	<b>A73088</b> *
LF 1/2"-50-CPR	CPR (B2 <sub>ca</sub> )	15.8 mm	125 mm	≤ 7.12 dB	≤ 1.06 kW	<b>A73028</b> *
LF 7/8"-50-PE	PE (F <sub>ca</sub> )	27.3 mm	250 mm	≤ 4.02 dB	≤ 2.25 kW	<b>A73089</b> *
LF 7/8"-50-CPR	CPR (B2 <sub>ca</sub> )	27.3 mm	250 mm	≤ 4.02 dB	≤ 2.25 kW	<b>A73029</b> *
LF 1 1/4"-50-PE	PE (F <sub>ca</sub> )	38.8 mm	380 mm	≤ 2.87 dB	≤ 3.42 kW	<b>A73090</b> **
LF 1 1/4"-50-FR	CPR (E <sub>ca</sub> )	38.8 mm	380 mm	≤ 2.87 dB	≤ 3.42 kW	<b>A73037</b> **
LF 1 5/8"-50-PE	PE (F <sub>ca</sub> )	49.5 mm	510 mm	≤ 2.38 dB	≤ 4.61 kW	<b>A73091</b> **
LF 1 5/8"-50-CPR	CPR (D <sub>ca</sub> )	49.5 mm	510 mm	≤ 2.38 dB	≤ 4.61 kW	<b>A73038</b> **

\* Ships on reels with a length of 500m ± 50m

\*\* Ships on reels with a length of 350m ± 30m



**A73151**



**A73088**



**A73089**



**A73090**



**A73091**



## SpinnerFlex® Cable

### SpinnerFlex Cables Certified acc. to the EU Construction Products Regulation

Sadly, building fires still take a considerable toll in terms of human lives. Yet in many cases, it isn't the fire itself that makes it hard to rescue people but the toxic gases that are present in dense smoke. Smoke also makes it difficult to see escape routes and locate injured persons. With the aims of reducing emissions of smoke and toxic gases, delaying their spread and extending the available time for leaving burning buildings, in 2013 the European Union issued the Construction Products Regulation (CPR), to establish harmonized rules for the marketing and use of construction products.

This regulation also affects the mobile communication market, because permanently installed cables in buildings and facilities can pose risks in connection with In-Building/DAS projects. The EU therefore decided that cabling for fixed installations may no longer be used unless it is tested and certified under the rules of the CPR.

Cables are assigned to different classes depending on their reaction to fire behavior. These range from readily flammable (Class F) to non-combustible (Class A). Other criteria such as smoke emissions, burning droplets and acidity are also taken into account. All of these properties are determined by independent testing institutions, which certify each product while assigning it to a harmonized euroclass with defined smoke emissions, burning droplets and acidity.

For stricter classes (the requirements increase from A to F), the tests that must be performed by a "notified body" (a third-party institute designated by the EU country concerned) are also more extensive. Classes A to D require not only testing of samples, but also regular factory audits and regular sample taking from ongoing production.

The CPR cables supplied under the SpinnerFlex brand name undergo these tests and are also certified as complying with EU Regulation no. EN 50575:2014. In addition to the fire classes, smoke generation (s), flaming droplets (d) and acidity (a) are also determined and presented.

SpinnerFlex CPR cables are available in SF 1/2"-50-CPR, LF 1/2"-50-CPR, LF 7/8"-50-CPR, LF 1 1/4"-50-FR and LF 1 5/8"-50-CPR versions. For part numbers, please refer to the previous page.



## Jumper Cables – Seriflex

Seriflex cables are designed for housing installations. They also meet the RoHS 2002/95 guideline. Upon request SPINNER delivers any cable length and connector combination.

### Seriflex 141-50-FEP (RG 402/U)



Seriflex 141-50-FEP can be customized using connector types 7-16, 4.3-10, N, 2.2-5 and SMA.

Electrical Specification				
Frequency ranges	≤ 960 MHz	≤ 2200 MHz	≤ 2700 MHz	≤ 3800 MHz
Insertion loss	≤ 0.401 dB/m	≤ 0.642 dB/m	≤ 0.722 dB/m	≤ 0.876 dB/m
Power rating @ 40 °C	≤ 425 W	≤ 275 W	≤ 245 W	≤ 200 W

### Seriflex 250-50-FEP (RG 401/U)



Seriflex 250-50-FEP can be customized using connector types 7-16, 4.3-10, N and 2.2-5.

Electrical Specification				
Frequency ranges	≤ 960 MHz	≤ 2200 MHz	≤ 2700 MHz	≤ 3800 MHz
Insertion loss	≤ 0.244 dB/m	≤ 0.403 dB/m	≤ 0.457 dB/m	≤ 0.562 dB/m
Power rating @ 40 °C	≤ 1080 W	≤ 680 W	≤ 610 W	≤ 500 W



## Jumper Cables – Seriflex Article Codes

Please use article codes for inquiries and orders.

These are self explaining and enable you to specify a product without knowing its part number.

Jumper	Cable Type	Cable Size	Cable Jacket	Connector 1	Connector 2	Length	Unit	Length	Extra Features		
<b>J</b>	<b>X</b>	<b>Z</b>	<b>X</b>	<b>-</b>	<b>XZ</b>	<b>XZ</b>	<b>-</b>	<b>X</b>	<b>Z</b>	<b>X</b>	<b>-Z</b>
Seriflex	X	250	Blank for FEP	Any combination of connectors below is possible. Please specify an XZ combination for connectors 1 and 2. In case of pigtail leave blank for connector 2							Leave blank if not applicable
250-50		250									
141-50		141									
086-50		086									
No Jacket			N								
Halogen Free			H								
X =	Z =			X	Z						
Connector System	Connector Style										
7-16	Male			7	M						
4.1-9.5	Male right angle			41	R						
N	Female (right angle)			N	F(R)						
TNC	Female bulkhead (r. a.)			T	B(R)						
SMA	Female four-hole panel (r. a.)			SA	P(R)						
4.3-10	Male; screw			43	MS						
2.2-5	Male; hand screw			22	MH						
NEX10®	Male; push-pull			X	MP						
	Male right angle; screw				RS						
	Male right angle; hand screw				RH						
	Male right angle; push-pull				RP						
	Female (right angle)				F(R)						
	Female bulkhead (right angle)				B(R)						
	Female four-hole panel (right angle)				P(R)						
Length in meters/feet (depending on unit specified)											
Meters as unit										M	
Feet as unit										F	
Length in decimeters/inches (depending on unit specified)											
Customized Label											L
Jumper set											S

**Example of article codes:**

**JX250-7M43RS-2M5:** 2.5-meter-long SX250-50 FEP jumper with 7-16 male and 4.3-10 male right angle screw type connectors.

## Filters



Since the demand for frequency bands in telecommunication keeps growing continuously the transmission and reception frequencies are getting closer all the time, causing more and more undesirable mutual interference and noise. This reduces the system power and finally results in lower throughput. It is most critical when bands which are close together are transmitted and received by the same transmission line.

### Maximize bandwidth usage

The filters have been designed for the lowest possible attenuation in the pass-band. This helps to minimise the inevitable loss of useful power (0.5 dB of attenuation are already equivalent to more than a 10% power loss). In addition our filters stand out for high stop-band attenuation and steep filter edges.

We customize most of our filters before dispatching them. The products for which this service is available are designated in our catalogue by the logo shown on the right. The technical data given for the VSWR, frequency range, isolation and loss of these products depend on the individual tuning. Before you place your order, we send you

a binding quotation indicating the specified technical data and measurement curves. To request a quotation for customized filters for your applications, please contact us at [info@spinner-group.com](mailto:info@spinner-group.com).



SPINNER delivers a broad variety of band-pass, band-stop and low-pass filters to ensure suitable solutions.

## Band-Pass Filters



### TETRA

Part Number	BN 616431	BN 616430
Pass-band	380 – 385 MHz	390 – 395 MHz
Pass-band loss	≤ 0.5 dB	
Stop-band	390 - 395 MHz 890 - 960 MHz	380 - 385 MHz 890 - 960 MHz
Stop-band loss	≥ 30 dB @ 390 – 395 MHz ≥ 50 dB @ 890 – 960 MHz	≥ 30 dB @ 380 – 385 MHz ≥ 50 dB @ 890 – 960 MHz
Passive intermodulation (IM3) @ 2 x 20 W	≤ -150 dBc; typ. ≤ -160 dBc	
VSWR	≤ 1.25	
Power rating	≤ 200 W	
Connectors	7-16 female	
Temperature range	-5 °C ... +60 °C	
Degree of protection (mated)	IP 54	
Weight	~ 1.7 kg	
Mounting brackets	<b>BN B07787</b>	



**BN 616431 / BN 616430**

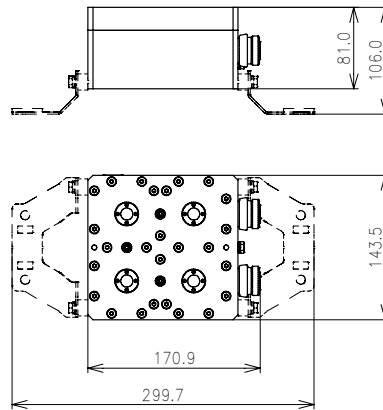

## Band-Pass Filters



LTE800 | GSM1800 | UMTS

Part Number	BN 616499	BN 616396	BN 616398
Pass-band	Tunable within 790 - 857 MHz	Tunable within 1710 - 1880 MHz	Tunable within 1920 - 2170 MHz
Pass-band loss	Dependent on tuning		
Stop-band	Tunable and dependent on pass-band		
Stop-band loss	Dependent on tuning		
Passive intermodulation (IM3) @ 2 x 20 W	≤ -150 dBc; typ. ≤ -160 dBc		
VSWR	Dependent on tuning		
Power rating	≤ 100 W		
Connectors	7-16 female		
Temperature range	-40 °C ... +65 °C		
Degree of protection (mated)	IP 65		
Weight	~ 3.5 kg	~ 1.2 kg	~ 1.7 kg
Mounting brackets	<b>BN B16603</b>	<b>BN B17365</b>	

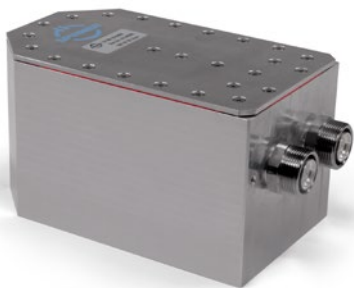

**BN 616499**

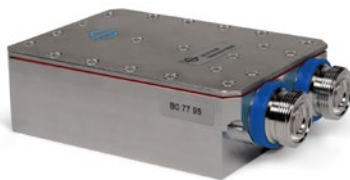
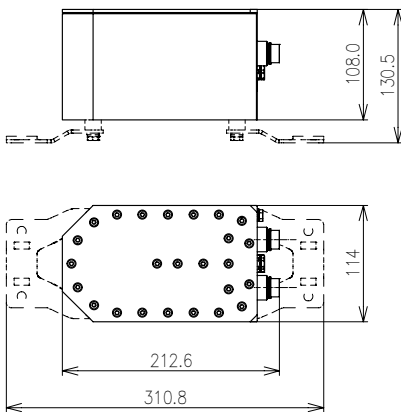

**BN 616396**

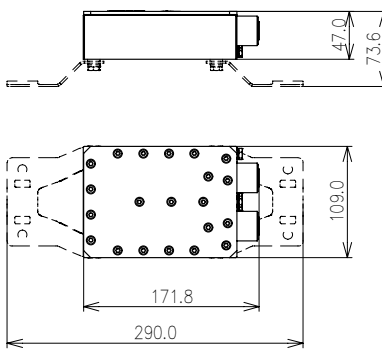

**BN 616398**

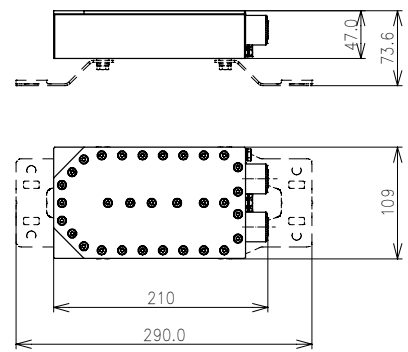

## Band-Stop Filters



### GSM-R

Part Number	BN 610007	BN 610015	BN 610017
Stop-band	873.1 – 880.1 MHz 918.1 – 925.1 MHz		
Stop-band loss	≥ 44 dB		
Pass-band	0.3 - 862.0 MHz 880.9 - 915.0 MHz 925.9 - 960.0 MHz 1710 - 1880 MHz 1920 - 2170 MHz 2500 - 2700 MHz		
Pass-band loss	≤ 1.0 dB @ 0.3 - 862.0 MHz ≤ 8.0 dB @ 880.9 - 883.5 MHz ≤ 1.0 dB @ 883.5 - 914.0 MHz ≤ 1.8 dB @ 914.0 - 915.0 MHz ≤ 8.0 dB @ 925.9 - 928.5 MHz ≤ 1.0 dB @ 928.5 - 960.0 MHz ≤ 1.0 dB @ 1710 - 1880 MHz ≤ 1.0 dB @ 1920 - 2170 MHz ≤ 1.0 dB @ 2500 - 2700 MHz		
Passive intermodulation (IM3) @ 2 x 20 W	≤ -150 dBc; typ. ≤ -160 dBc		
VSWR	≤ 1.29		
Power rating	≤ 200 W		
Connectors	7-16 female	4.3-10 female	N female
Temperature range	-25 °C ... +85 °C		
Degree of protection (mated)	IP 65		
Weight	~ 15 kg		
Mounting brackets	<b>BN B07787</b>		



**BN 610007**

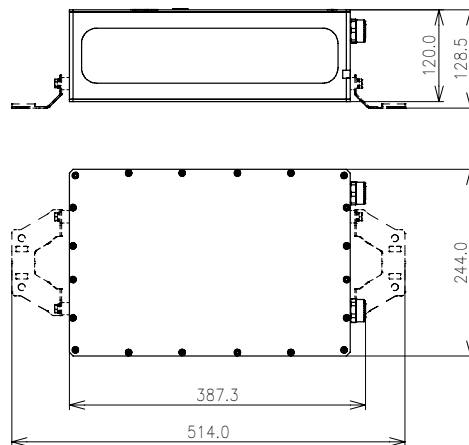

## Band-Stop Filters



### GSM-R

Part Number	BN 616314	BN 616313
Stop-band		876 - 880 MHz 921 - 925 MHz
Stop-band loss		≥ 50 dB
Pass-band		890 – 915 MHz 935 – 960 MHz 1710 – 1880 MHz 1920 – 2170 MHz
Pass-band loss		≤ 0.7 dB @ 890 – 915 MHz ≤ 0.4 dB @ 935 – 960 MHz ≤ 0.2 dB @ 1710 – 1880 MHz ≤ 0.2 dB @ 1920 – 2170 MHz
Passive intermodulation (IM3) @ 2 x 20 W		≤ -150 dBc; typ. ≤ -160 dBc
VSWR		≤ 1.29
Power rating		≤ 200 W
Connectors	7-16 female	N female
Temperature range		-40 °C ... +85 °C
Degree of protection (mated)		IP 65
Weight		~ 6.5 kg
Mounting brackets		N/A



**BN 616313**

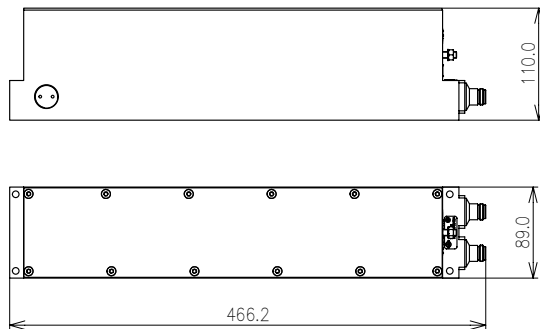



## Band-Stop Filters



### GSM900 | UMTS

Part Number	BN 610003	BN 570552	BN 570554
Stop-band	Tunable within 900 MHz band		Tunable within 1800 MHz band
Stop-band loss	Dependent on tuning		
Pass-band	Tunable and dependent on stop-band		
Pass-band loss	Dependent on tuning		
Passive intermodulation (IM3) @ 2 x 2 W (BN 610003) @ 2 x 20 W (BN 570552 / BN 570554)	≤ -130 dBc	≤ -150 dBc; typ. ≤ -155 dBc	
VSWR	Dependent on tuning		
Power rating	≤ 10 W	≤ 150 W	≤ 500 W
Connectors	7-16 female		
Temperature range	-25 °C ... +55 °C	-10 °C ... +60 °C	
Degree of protection (mated)	IP 65		
Weight	~ 3.6 kg	~ 5 kg	
Mounting brackets	Included	<b>BN B16603</b>	



**BN 610003**

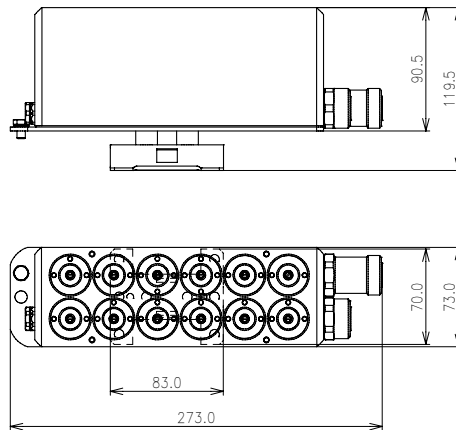

## Low-Pass Filters



≤ 500 MHz | ≤ 614 MHz

Part Number	BN 616331	BN 616439
Pass-band	0 - 500 MHz	0 - 614 MHz
Pass-band loss	≤ 0.20 dB	≤ 0.20 dB
Stop-band	800 - 2200 MHz	800 - 2170 MHz
Stop-band loss	≥ 45 dB @ 800 - 876 MHz ≥ 55 dB @ 876 - 2200 MHz	≥ 30 dB @ 800 - 860 MHz ≥ 40 dB @ 860 - 960 MHz ≥ 70 dB @ 1710 - 2170 MHz
Passive intermodulation (IM3) @ 2 x 20 W	≤ -150 dBc; typ. ≤ -160 dBc	
VSWR	≤ 1.25 @ 0 - 380 MHz ≤ 1.14 @ 380 - 500 MHz	≤ 1.40 @ 0 - 380 MHz ≤ 1.15 @ 380 - 614 MHz
Power rating	≤ 150 W	
Connectors	7-16 female	
Temperature range	-40 °C ... +65 °C	
Degree of protection (mated)	IP 65	
Weight	~ 1.4 kg	
Mounting brackets	Included	

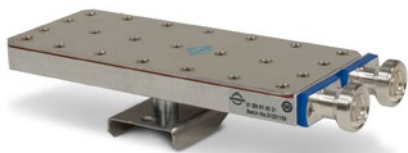

BN 616331 / 616439

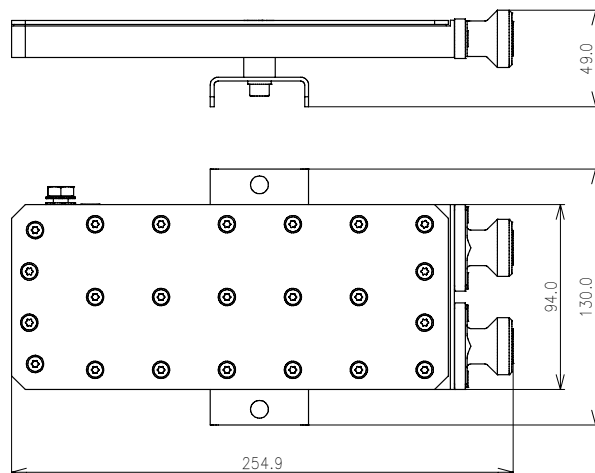

## Uplink / Downlink Filters

SPINNER offers uplink/downlink (UL/DL) filters, which consist of a parallel circuit each with one band-pass filter for the reception and transmission signal. In comparison to a single band-pass filter, UL/DL filter offer the advantage of also eliminating signals which are between the transmitted and received band. Furthermore, the lower bandwidth means that a significantly larger edge steepness is possible which in turn leads to higher isolation values.

As with all SPINNER filters, the uplink/downlink filters are designed for minimum insertion loss and highest edge steepness. Furthermore, the filters are adjustable in the complete frequency band (LTE700/LTE800, CDMA850/GSM900, GSM1800/UMTS and LTE2600) with a bandwidth of ~ 5 MHz to 20 MHz and can therefore be individually tuned to your requirements.

Depending on requirements, there is a selection of 4 and 6 cavity filter types available. All UL/DL filters are suitable for outdoor installation. Their compact design means that they have a low weight and wind load which are key advantages when being used e.g. on a mobile site.

Please let us know your requirements so we can suggest the best possible solution.



### LTE700 | LTE800 | GSM850 | GSM900

Part Number	BN 570569	BN 610011	BN 570568	BN 570668
Version	Single	Double	Single	Double
Cavities	4	4	6	6
Frequency range	694 - 960 MHz			
Insertion loss	Dependent on tuning			
Isolation	Dependent on tuning			
Passive intermodulation (IM3) @ 2 x 20 W	≤ -150 dBc; typ. ≤ -160 dBc			
VSWR	Dependent on tuning			
Power rating	≤ 100 W			
Connectors	7-16 female			
Temperature range	-25 °C ... +65 °C			
Degree of protection (mated)	IP 65			
Weight	~ 4.3 kg	~ 8.7 kg	~ 6.7 kg	~ 12.0 kg
Mounting brackets	<b>BN B16603</b>	Included	<b>BN B16603</b>	Included

## Uplink / Downlink Filters



### GSM1800 | UMTS2100

Part Number	BN 570571	BN 610013	BN 570572	BN 570672
Version	Single	Double	Single	Double
Cavities	4	4	6	6
Frequency range	1710 - 2170 MHz			
Insertion loss	Dependent on tuning			
Isolation	Dependent on tuning			
Passive intermodulation (IM3) @ 2 x 20 W	≤ -150 dBc; typ. ≤ -160 dBc			
VSWR	Dependent on tuning			
Power rating	≤ 100 W			
Connection	7-16 female			
Temperature range	-25 °C ... +65 °C			
Degree of protection (mated)	IP 65			
Weight	~ 3.0 kg	~ 6.4 kg	~ 5.0 kg	~ 10.4 kg
Mast or wall mounting brackets	<b>BN B16603</b>	Included	<b>BN B16603</b>	Included



### LTE2600

Part Number	BN 570573	BN 610014	BN 570574	BN 570674
Version	Single	Double	Single	Double
Cavities	4	4	6	6
Frequency range	2500 - 2690 MHz			
Insertion loss	Dependent on tuning			
Isolation	Dependent on tuning			
Passive intermodulation (IM3) @ 2 x 20 W	≤ -150 dBc; typ. ≤ -160 dBc			
VSWR	Dependent on tuning			
Power rating	≤ 100 W			
Connection	7-16 female			
Temperature range	-25 °C ... +65 °C			
Degree of protection (mated)	IP 65			
Weight	~ 2.9 kg	~ 6.4 kg	~ 5.0 kg	~ 10.0 kg
Mast or wall mounting brackets	<b>BN B16603</b>	Included	<b>BN B16603</b>	Included

## Combining Products and Systems

SPINNER develops and manufactures innovative combining products for all mobile communication bands. They are excellently suited as single- and multi-carrier solutions for shared use of antenna installations.

Their outstanding properties include minimal insertion loss, excellent isolation, and extremely low intermodulation. This ensures maximum bandwidth use while minimizing the chance of problems.

### Multiband Combiners



#### Combining multiple different bands

- Diplexer
- Triplexer
- Quadruplexer
- Pentaplexer
- Hexaplexer

### Multiband Combining Systems



#### Combining multiple different bands and multiple carriers

Input ports : output ports

- 2 : 1
- 3 : 3    6 : 3    9 : 3    12 : 3
- 4 : 4    8 : 4    12 : 4    16 : 4    20 : 4

### Sameband Combiners



#### Combining multiple carriers within the same band

Available for different frequency bands as 4 and 6 cavity sameband combiner.

### Mobile Network Combining System (MNCS®)



#### Combining multiple bands and multiple carriers

A fully customizable In-Building solution for feeding a distributed antenna system. The components are tuned to individual frequency plans and designed to ensure the greatest possible bandwidth. Modular rack architecture for easy extension at any time.

## Multiband Combiners

### Diplexers, Triplexers, Quadruplexers, Pentaplexers, Hexaplexer

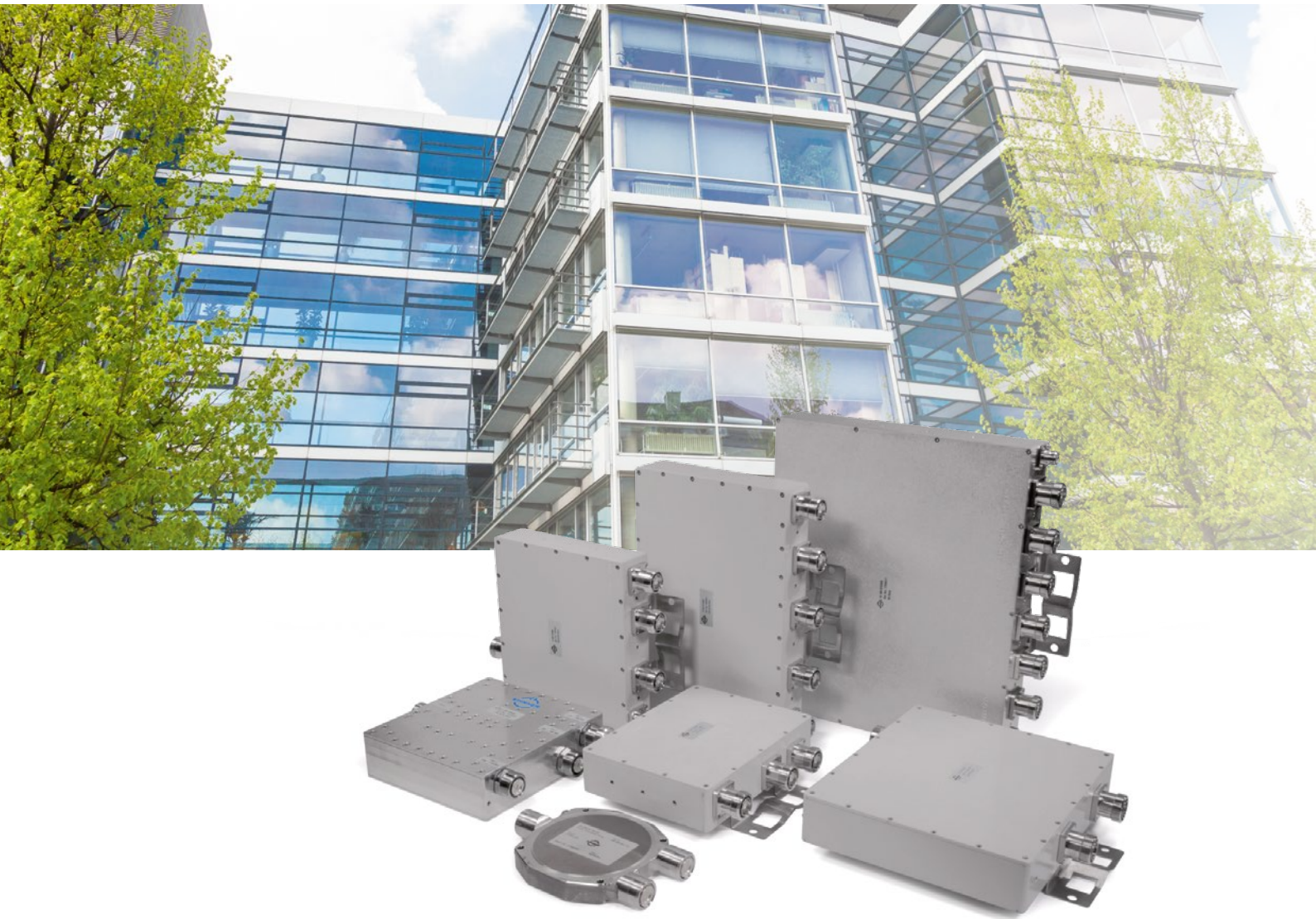

**Frequency combiners are used to isolate two or more channels on different frequencies, thus allowing the common use of one antenna feeder cable or one antenna by several transmitters or receivers.**

Our combiners are available for frequency bands in the range from 0 to 3800 MHz, making our multiband combiner families ideal for the common utilization of antenna equipment by several mobile communication systems.

Besides solutions for GSM900, GSM1800, PCS1900, UMTS and LTE, SPINNER also offers diplexers for analogue radio, TETRA, DVB-H, DMB, WLAN and WiMAX.

All combiners work in bi-directional mode and can therefore be used to combine and split the transmitted and received signals.

Very low insertion loss, excellent signal isolation and superior intermodulation properties prevent mutual interference between adjacent systems. AISG/3GPP-compatible DC connections allow the transfer of control signals to the antenna as well as the power supply for antenna pre-amplifiers.

All combining products are suited for indoor and outdoor installation.



## Multiband Combiners Diplexers, Triplexers, Quadruplexers, Pentaplexers, Hexaplexer

Frequency Range in MHz															
	350 - 475	694 - 788	791 - 862	876 - 960	1427 - 1518	1710 - 1880	1850 - 1990	1920 - 2170	2300 - 2400	2400 - 2500	2496 - 2690	3300 - 3800			
Examples															
	TETRA PMR	LTE700	LTE800	LTE900 GSM900 GSM-R	LTE1500 L-Band	GSM1800 LTE1800 AWS RX	PCS1900	UMTS AWS TX	LTE2300	WLAN	LTE2500 LTE2600	5G			
Type													Page		
Diplexer	Port 1 DC - 2170 MHz										Port 2 2496 - 2690 MHz			88	
	Port 1 DC - 2700 MHz											Port 2 3300 - 3800 MHz		89	
	Port 2 68 - 490 MHz		Port 1 698 - 960 MHz				Port 1 1710 - 2690 MHz						90		
	Port 1 350 - 960 MHz						Port 2 1710 - 3800 MHz							92	
	Port 1 440 - 475 MHz			Port 2 870 - 960 MHz										93	
	Port 1 694 - 960 MHz					Port 2 1710 - 2170 MHz								94	
	Port 1 694 - 960 MHz										Port 2 2400 - 2690 MHz			96	
		Port 1 790 - 862 MHz		Port 2 880 - 960 MHz										97	
	Port 1 790 - 960 MHz				Port 2 1710 - 2170 MHz								98		
					Port 1 1710 - 1880 MHz			Port 2 1920 - 2170 MHz						99	
					Port 1 1710 - 1880 MHz			Port 2 1920 - 2690 MHz					100		
				Port 1 1710 - 2170 MHz						Port 2 2496 - 2690 MHz		101			
Triplexer	Port 1 694 - 960 MHz					Port 2 1710 - 1880 MHz			Port 3 1920 - 2170 MHz				103		
	Port 1 690 - 960 MHz					Port 2 1710 - 2170 MHz			Port 3 2300 - 2700 MHz			105			
					Port 1 1710 - 1880 MHz			Port 2 1920 - 2170 MHz			Port 3 2500 - 2690 MHz		106		
Quadru-plexer	Port 1 694 - 960 MHz					Port 2 1710 - 1880 MHz			Port 3 1920 - 2170 MHz			Port 4 2500 - 2690 MHz		107	
Penta-plexer	Port 1 694 - 862 MHz		Port 2 880 - 960 MHz			Port 3 1710 - 1880 MHz			Port 4 1920 - 2170 MHz			Port 5 2500 - 2690 MHz		109	
Hexa-plexer	Port 1 694 - 870 MHz		Port 2 880 - 960 MHz			Port 3 1710 - 1880 MHz			Port 4 1920 - 2170 MHz		Port 5 2300 - 2400 MHz		Port 6 2500 - 2700 MHz		110

## Multiband Combiners



### Diplexers

Part Number	BN 572674	BN 572677	BN 572668	BN 572669
Version	Single	Double	Single	Double
Frequency range Port 1 Port 2 Port 3	DC - 2170 MHz 2496 - 2690 MHz Common			
Insertion loss Port 1 -> port 3	≤ 0.30 dB			
Isolation	≥ 50 dB			
Passive intermodulation (IM3) @ 2 x 20 W	≤ -160 dBc			
VSWR	≤ 1.25			
Power rating Port 1 Port 2	≤ 600 W ≤ 100 W		≤ 500 W ≤ 100 W	
DC and AISG	1 A (port 1 -> port 3)			
Connectors	7-16 female		4.3-10 female	
Temperature range	-40 °C ... +55 °C			
Degree of protection (mated)	IP 67			
Weight	~ 2.5 kg	~ 5.5 kg	~ 2.5 kg	~ 5.5 kg
Mounting bracket	Included			



BN 572674

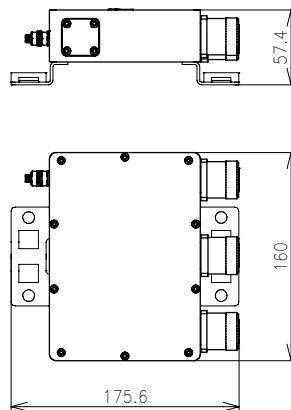



## Multiband Combiners

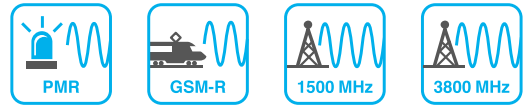

### Diplexer

Part Number	BN 570732	BN 570756
Version	Single	Double
Frequency range Port 1 Port 2 Port 3	DC - 2700 MHz 3300 - 3800 MHz Common	
Insertion Loss Port 1 -> port 3	≤ 0.50 dB	
Isolation	≥ 50 dB	
Passive intermodulation (IM3) @ 2 x 20 W	≤ -155 dBc	
VSWR	≤ 1.25	
Power rating Port 1 Port 2	≤ 300 W ≤ 60 W	
DC and AISG	1 A (port 1 -> port 3)	
Connectors	4.3-10 female	
Temperature range	-40 °C ... +60 °C	
Degree of protection (mated)	IP 65	
Weight	~ 6 kg	~ 12 kg
Mounting bracket	Included	



BN 570732

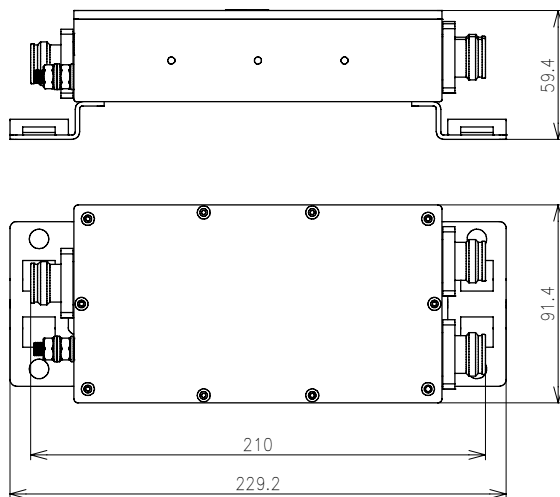

## Multiband Combiners



### Diplexers

Part Number	BN 573189	BN 573191	BN 570637	BN 570638
Version	Single	Double	Single	Double
Frequency range				
Port 1	range 1 range 2 range 3 range 4		698 - 800 MHz 800 - 960 MHz 1710 - 2500 MHz 2500 - 2690 MHz	
Port 2	range 5 range 6 range 7 range 8		68 - 200 MHz 200 - 380 MHz 380 - 470 MHz 470 - 490 MHz	
Port 3			Common	
Insertion loss				
Port 1 -> port 3	range 1 range 2, 3, 4		≤ 0.3 dB ≤ 0.2 dB	
Port 2 -> port 3	range 5, 6, 7 range 8		≤ 0.2 dB ≤ 0.3 dB	
Isolation				
Port 1 -> port 2	range 1 range 2, 3 range 4		≥ 30 dB ≥ 50 dB ≥ 40 dB	
Port 2 -> port 1	range 5, 6, 7 range 8		≥ 30 dB ≥ 25 dB	
Passive intermodulation (IM3) @ 2 x 20 W				≤ -155 dBc; typ. ≤ -160 dBc
VSWR				
Port 1	range 1 range 2, 3, 4		≤ 1.35 ≤ 1.2	
Port 2	range 5, 6, 7 range 8		≤ 1.2 ≤ 1.35	
Power rating				
Port 1				≤ 500 W
Port 2				≤ 300 W
DC and AISG		N/A		1 A (port 2 -> port 3)
Connectors				7-16 female
Temperature range				-25 °C ... +65 °C
Degree of protection (mated)				IP 68
Weight	~ 1.5 kg	~ 3.6 kg	~ 1.5 kg	~ 3.6 kg
Mounting brackets				Included

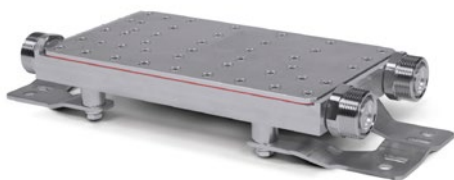

BN 573189

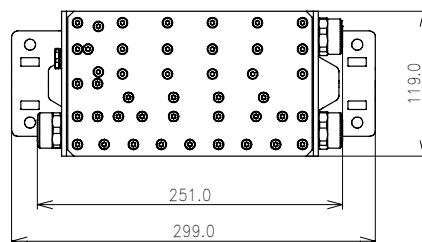
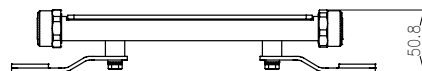

## Multiband Combiners



### Diplexers

Part Number	BN 572670	BN 572671	BN 572672	BN 572673
Version	Single	Double	Single	Double
Frequency range				
Port 1	range 1 range 2 range 3 range 4		698 - 800 MHz 800 - 960 MHz 1710 - 2500 MHz 2500 - 2690 MHz	
Port 2	range 5 range 6 range 7 range 8		68 - 200 MHz 200 - 380 MHz 380 - 470 MHz 470 - 490 MHz	
Port 3			Common	
Insertion loss				
Port 1 -> port 3	range 1 range 2, 3, 4		≤ 0.3 dB ≤ 0.2 dB	
Port 2 -> port 3	range 5, 6, 7 range 8		≤ 0.2 dB ≤ 0.3 dB	
Isolation				
Port 1 -> port 2	range 1 range 2, 3 range 4		≥ 30 dB ≥ 50 dB ≥ 40 dB	
Port 2 -> port 1	range 5, 6, 7 range 8		≥ 30 dB ≥ 25 dB	
Passive intermodulation (IM3) @ 2 x 20 W				≤ -155 dBc; typ. ≤ -160 dBc
VSWR				
Port 1	range 1 range 2, 3, 4		≤ 1.35 ≤ 1.2	
Port 2	range 5, 6, 8 range 7		≤ 1.2 ≤ 1.35	
Power rating				
Port 1				≤ 500 W
Port 2				≤ 300 W
DC and AISG		N/A		1 A (port 2 -> port 3)
Connectors				4.3 - 10 female
Temperature range				-25 °C ... +65 °C
Degree of protection (mated)				IP 68
Weight	~ 1.5 kg	~ 3.6 kg	~ 1.5 kg	~ 3.6 kg
Mounting brackets				Included

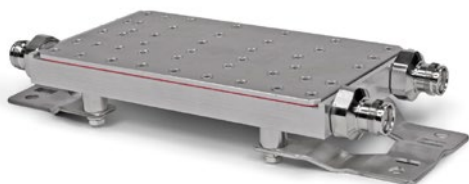

BN 572670

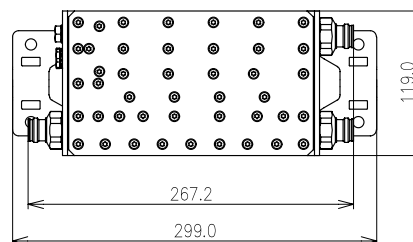

## Multiband Combiners



### Diplexer

<b>Part Number</b>	<b>BN 570744</b>
Version	Single
Frequency range Port 1 Port 2 Port 3	350 - 960 MHz 1710 - 3800 MHz Common
Insertion loss	≤ 0.50 dB; typ. ≤ 0.30 dB
Isolation	≥ 50 dB; typ. ≥ 60 dB
Passive intermodulation (IM3) @ 2 x 20 W	≤ -155 dBc; typ. ≤ -160 dBc
VSWR	≤ 1.25; typ. ≤ 1.20
Power rating	≤ 250 W
DC and AISG	1 A (port 1 -> port 3)
Connectors	4.3-10 female
Temperature range	-20 °C ... +60 °C
Degree of protection (mated)	IP 67
Weight	~ 2.0 kg
Mounting brackets	Included



**BN 570744**

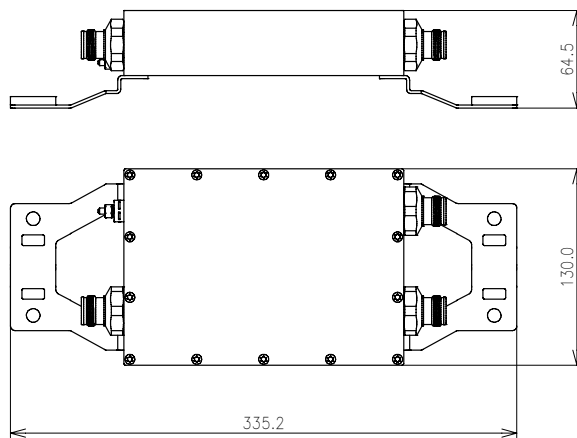

## Multiband Combiners



### Diplexer

<b>Part Number</b>	<b>BN 572924</b>
Version	Single
Frequency range Port 1 Port 2 Port 3	440 - 475 MHz 870 - 960 MHz Common
Insertion loss	≤ 0.20 dB
Isolation	≥ 60 dB
Passive intermodulation (IM3) @ 2 x 20 W	≤ -150 dBc; typ. ≤ -160 dBc
VSWR	≤ 1.15
Power rating	≤ 50 W
DC and AISG	N/A
Connectors	N female
Temperature range	-40 °C ... +70 °C
Degree of protection (mated)	IP 60
Weight	~ 1.3 kg
Mounting brackets	N/A



**BN 572924**

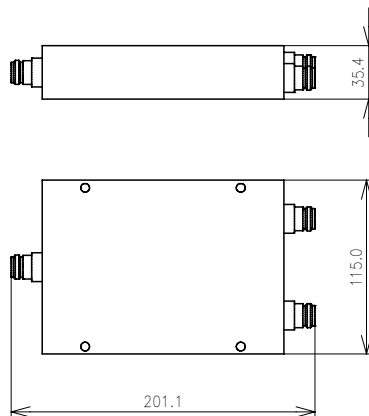

## Multiband Combiners



### Diplexers

Part Number	BN 570511	BN 570513	BN 570510	BN 570512
Version	Single	Double	Single	Double
Frequency range Port 1 Port 2 Port 3	694 - 960 MHz 1710 - 2170 MHz Common			
Insertion loss Port 1 -> port 3 Port 2 -> port 3	≤ 0.12 dB ≤ 0.15 dB			
Isolation	≥ 50 dB			
Passive intermodulation (IM3) @ 2 x 20 W	≤ -165 dBc; typ. ≤ -170 dBc			
VSWR	≤ 1.2			
Power rating Port 1 Port 2	≤ 570 W ≤ 380 W			
DC and AISG	5 A (port 2 -> port 3)		5 A (all ports)	
Connectors	7-16 female			
Temperature range	-40 °C ... +85 °C			
Degree of protection (mated)	IP 68			
Weight	~ 0.8 kg	~ 1.9 kg	~ 0.8 kg	~ 1.9 kg
Mounting brackets	<b>BN B08962</b>	Included	<b>BN B08962</b>	Included



**BN 570510**

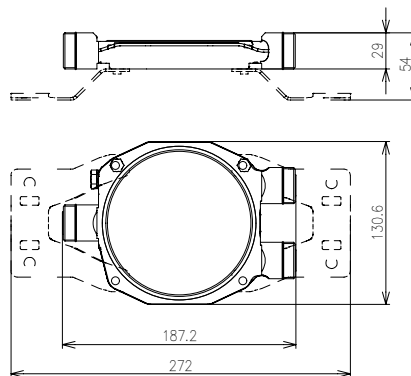

## Multiband Combiners



### Diplexers

Part Number	BN 572639	BN 572641	BN 572638	BN 572640
Version	Single	Double	Single	Double
Frequency range Port 1 Port 2 Port 3	694 - 960 MHz 1710 - 2170 MHz Common			
Insertion loss Port 1 -> port 3 Port 2 -> port 3	≤ 0.12 dB ≤ 0.15 dB			
Isolation	≥ 50 dB			
Passive intermodulation (IM3) @ 2 x 20 W	≤ -165 dBc; typ. ≤ -170 dBc			
VSWR	≤ 1.2			
Power rating Port 1 Port 2	≤ 350 W ≤ 250 W			
DC and AISG	5 A (port 2 -> port 3)		5 A (all ports)	
Connectors	4.3-10 female			
Temperature range	-40 °C ... +85 °C			
Degree of protection (mated)	IP 68			
Weight	~ 0.7 kg	~ 1.7 kg	~ 0.7 kg	~ 1.7 kg
Mounting brackets	<b>BN B08962</b>	Included	<b>BN B08962</b>	Included



**BN 572638**

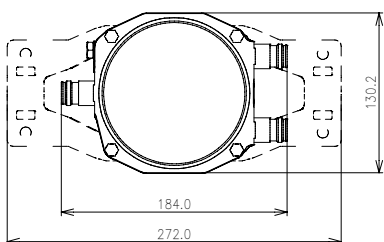
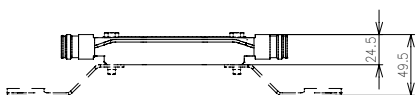

**BN 572640**

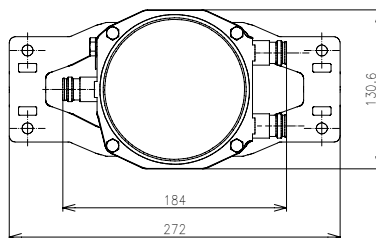
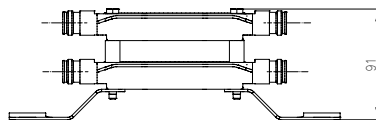

## Multiband Combiners



### Diplexers

Part Number	BN 572648	BN 572650	BN 572649	BN 572651
Version	Single	Double	Single	Double
Frequency range Port 1 Port 2 Port 3	694 - 960 MHz 2400 - 2690 MHz Common			
Insertion loss Port 1 -> port 3 Port 2 -> port 3	≤ 0.12 dB ≤ 0.15 dB			
Isolation	≥ 50 dB			
Passive intermodulation (IM3) @ 2 x 20 W	≤ -165 dBc; typ. ≤ -170 dBc			
VSWR	≤ 1.2			
Power rating Port 1 Port 2	≤ 400 W ≤ 200 W			
DC and AISG	5 A (port 2 -> port 3)		5 A (all ports)	
Connectors	4.3-10 female			
Temperature range	-40 °C ... +85 °C			
Degree of protection (mated)	IP 68			
Weight	~ 0.7 kg	~ 1.7 kg	~ 0.7 kg	~ 1.7 kg
Mounting brackets	BN B08962	Included	BN B08962	Included



BN 572649

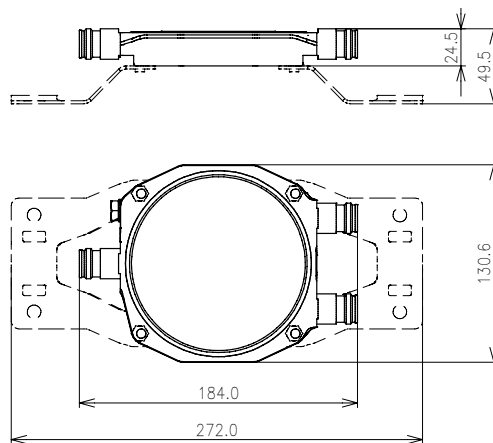



## Multiband Combiners

### Diplexers

Part Number	BN 576115	BN 576116	BN 576117	BN 576118
Version	Single	Double	Single	Double
Frequency range Port 1 Port 2 Port 3	790 - 862 MHz 880 - 960 MHz Common			
Insertion loss	≤ 0.4 dB; typ. ≤ 0.25 dB			
Isolation	≥ 55 dB; typ. ≥ 60 dB		≥ 50 dB; typ. ≥ 55 dB	
Passive intermodulation (IM3) @ 2 x 20 W	≤ -155 dBc; typ. ≤ -160 dBc		≤ -160 dBc; typ. ≤ -165 dBc	
VSWR	≤ 1.25; typ. ≤ 1.2			
Power rating	≤ 300 W			
DC and AISG	1 A (all ports)			
Connectors	7-16 female		4.3-10 female	
Temperature range	-40 °C ... +65 °C			
Degree of protection (mated)	IP 68			
Weight	~ 4 kg	~ 8 kg	~ 4 kg	~ 8 kg
Mounting brackets	Included			



BN 576115

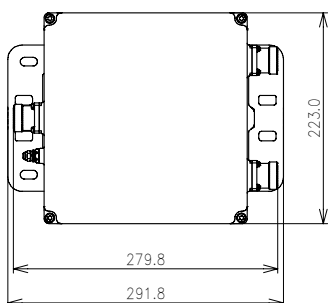
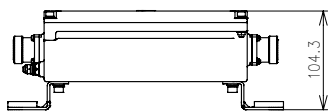

BN 576116

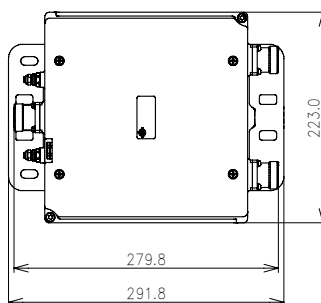
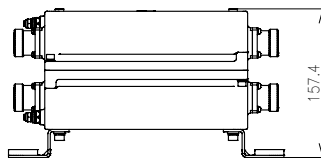

## Multiband Combiners



### Diplexers

Part Number	BN 573641	BN 573643	BN 573640	BN 573642
Version	Single	Double	Single	Double
Frequency range Port 1 Port 2 Port 3	790 - 960 MHz 1710 - 2170 MHz Common			
Insertion loss Port 1 -> port 3 Port 2 -> port 3	≤ 0.12 dB ≤ 0.15 dB			
Isolation	≥ 45 dB			
Passive intermodulation (IM3) @ 2 x 20 W	≤ -165 dBc; typ. ≤ -170 dBc			
VSWR	≤ 1.2; typ. ≤ 1.1			
Power rating Port 1 Port 2	≤ 570 W ≤ 380 W			
DC and AISG	5 A (port 2 -> port 3)		5 A (all ports)	
Connectors	7-16 female			
Temperature range	-40 °C ... +85 °C			
Degree of protection (mated)	IP 68			
Weight	~ 0.8 kg	~ 1.8 kg	~ 0.8 kg	~ 1.8 kg
Mounting brackets	<b>BN B08962</b>	Included	<b>BN B08962</b>	Included



**BN 573640**

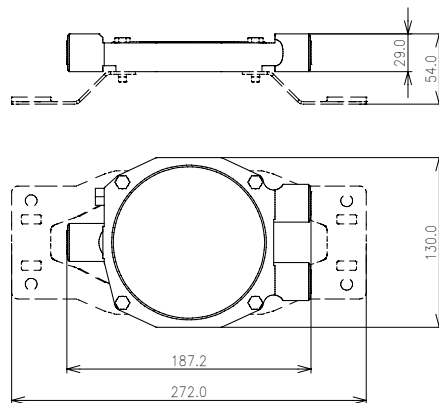

## Multiband Combiners

### Diplexers

Part Number	BN 572664	BN 572667	BN 572665	BN 572666
Version	Single	Double	Single	Double
Frequency range Port 1 Port 2 Port 3	1710 - 1880 MHz 1920 - 2170 MHz Common			
Insertion loss Port 1 -> port 3 Port 2 -> port 3	≤ 0.35 dB ≤ 0.45 dB			
Isolation	≥ 50 dB			
Passive intermodulation (IM3) @ 2 x 20 W	≤ -155 dBc; typ. ≤ -160 dBc			
VSWR	≤ 1.22			
Power rating	≤ 250 W			
DC and AISG	3 A (port 2 -> port 3)		3 A (all ports)	
Connectors	7-16 female			
Temperature range	-40 °C ... +60 °C			
Degree of protection (mated)	IP 65			
Weight	~ 3 kg	~ 6 kg	~ 3 kg	~ 6 kg
Mounting brackets	Included			



**BN 572665**

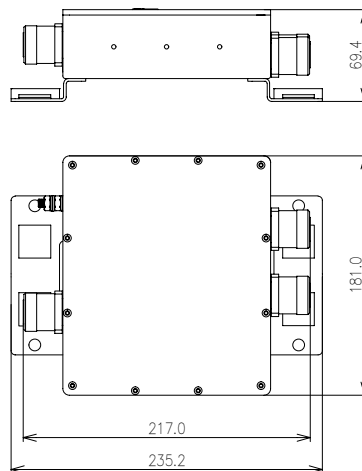

## Multiband Combiners

### Diplexers

Part Number	BN 572612	BN 572613	BN 572610	BN 572611
Version	Single	Double	Single	Double
Frequency range Port 1 Port 2 range 1 Port 3 range 2	1710 - 1880 MHz 1920 - 2170 MHz 2300 - 2690 MHz Common			
Insertion loss Port 1 -> port 3 Port 2 -> port 3	$\leq 0.35$ dB $\leq 0.45$ dB			
Isolation	$\geq 50$ dB			
Passive intermodulation (IM3) @ 2 x 20 W	$\leq -155$ dBc; typ. $\leq -160$ dBc			
VSWR	$\leq 1.25$			
Power rating	$\leq 250$ W			
DC and AISG	3 A (port 2 -> port 3)		3 A (all ports)	
Connectors	4.3-10 female			
Temperature range	$-20$ °C ... $+55$ °C			
Degree of protection (mated)	IP 65			
Weight	~ 3 kg	~ 6 kg	~ 3 kg	~ 6 kg
Mounting brackets	Included			



BN 572612

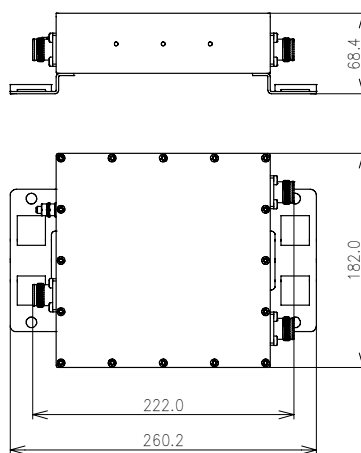

## Multiband Combiners

### Diplexers

Part Number	BN 570528	BN 572620	BN 573621	BN 572621	BN 573622	BN 572622
Version	Single	Double	Single	Double	Single	Double
Frequency range Port 1 Port 2 Port 3	1710 - 2170 MHz 2496 - 2690 MHz Common					
Insertion loss Port 1 -> port 3 Port 2 -> port 3	≤ 0.20 dB; typ. ≤ 0.12 dB ≤ 0.20 dB; typ. ≤ 0.15 dB					
Isolation	≥ 50 dB					
Passive intermodulation (IM3) @ 2 x 20 W	≤ -165 dBc; typ. ≤ -170 dBc					
VSWR	≤ 1.2					
Power rating Port 1 Port 2	≤ 400 W ≤ 200 W					
DC and AISG	5 A (port 1 -> port 3)		5 A (port 2 -> port 3)		5 A (all ports)	
Connectors	7-16 female					
Temperature range	-40 °C ... +85 °C					
Degree of protection (mated)	IP 68					
Weight	~ 0.9 kg	~ 2 kg	~ 0.9 kg	~ 2 kg	~ 0.9 kg	~ 2 kg
Mounting brackets	<b>BN B08962</b>	Included	<b>BN B08962</b>	Included	<b>BN B08962</b>	Included



**BN 570528**

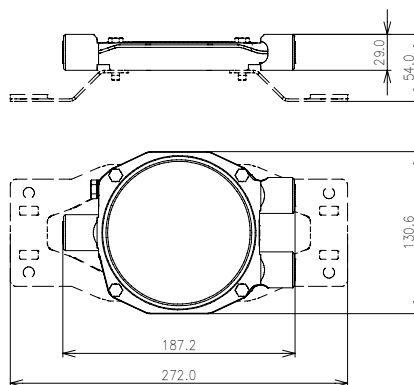

## Multiband Combiners

### Diplexers

Part Number	BN 572654	BN 572657	BN 572655	BN 572658	BN 572656	BN 572659
Version	Single	Double	Single	Double	Single	Double
Frequency range Port 1 Port 2 Port 3	1710 - 2170 MHz 2496 - 2690 MHz Common					
Insertion loss Port 1 -> port 3 Port 2 -> port 3	≤ 0.20 dB; typ. ≤ 0.12 dB ≤ 0.20 dB; typ. ≤ 0.15 dB					
Isolation	≥ 50 dB					
Passive intermodulation (IM3) @ 2 x 20 W	≤ -165 dBc; typ. ≤ -170 dBc					
VSWR	≤ 1.2					
Power rating Port 1 Port 2	≤ 300 W ≤ 150 W					
DC and AISG	5 A (port 1 -> port 3)		5 A (port 2 -> port 3)		5 A (all ports)	
Connectors	4.3-10 female					
Temperature range	-40 °C – +85 °C					
Degree of protection (mated)	IP 68					
Weight	~ 0.7 kg	~ 1.7 kg	~ 0.7 kg	~ 1.7 kg	~ 0.7 kg	~ 1.7 kg
Mounting brackets	<b>BN B08962</b>	Included	<b>BN B08962</b>	Included	<b>BN B08962</b>	Included



BN 572659

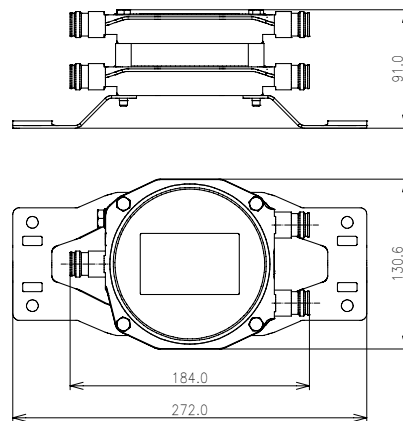

## Multiband Combiners



### Triplexers

Part Number	BN 570703	BN 570705	BN 570702	BN 570704
Version	Single	Double	Single	Double
Frequency range Port 1 Port 2 Port 3 Port 4	694 - 960 MHz 1710 - 1880 MHz 1920 - 2170 MHz Common			
Insertion loss Port 1 -> port 4 Port 2 -> port 4 Port 3 -> port 4	≤ 0.20 dB ≤ 0.35 dB ≤ 0.45 dB			
Isolation	≥ 50 dB			
Passive intermodulation (IM3) @ 2 x 20 W	≤ -155 dBc; typ. ≤ -160 dBc			
VSWR	≤ 1.22			
Power rating	≤ 250 W			
DC and AISG	1 A (port 3 -> port 4)		1 A (all ports)	
Connectors	7-16 female			
Temperature range	-40 °C ... +60 °C			
Degree of protection (mated)	IP 65			
Weight	~ 3.3 kg	~ 6.6 kg	~ 3.3 kg	~ 6.6 kg
Mounting brackets	Included			



BN 570702

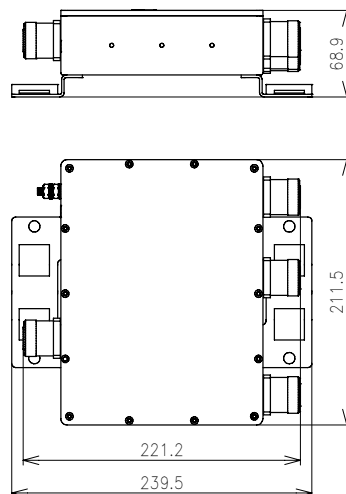

## Multiband Combiners



### Triplexers

Part Number	BN 570721	BN 570723	BN 570720	BN 570722
Version	Single	Double	Single	Double
Frequency range Port 1 Port 2 Port 3 Port 4	694 - 960 MHz 1710 - 1880 MHz 1920 - 2170 MHz Common			
Insertion loss Port 1 -> port 4 Port 2 -> port 4 Port 3 -> port 4	≤ 0.20 dB ≤ 0.35 dB ≤ 0.45 dB			
Isolation	≥ 50 dB			
Passive intermodulation (IM3) @ 2 x 20 W	≤ -155 dBc; typ. ≤ -160 dBc			
VSWR	≤ 1.22			
Power rating	≤ 250 W			
DC and AISG	1 A (port 3 -> port 4)		1 A (all ports)	
Connectors	4.3-10 female			
Temperature range	-40 °C ... +60 °C			
Degree of protection (mated)	IP 65			
Weight	~ 3.3 kg	~ 6.6 kg	~ 3.3 kg	~ 6.6 kg
Mounting brackets	Included			



**BN 570720**

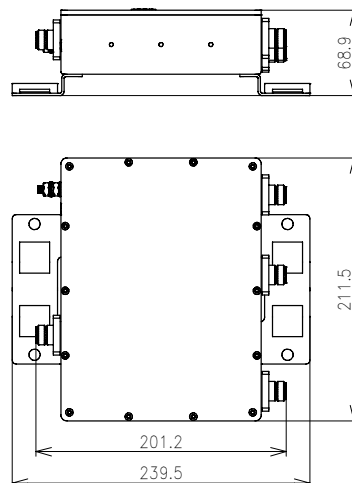



## Multiband Combiners

### Triplexers

Part Number	BN 570747	BN 570748	BN 570749	BN 570750
Version	Single	Double	Single	Double
Frequency range Port 1 Port 2 Port 3 Port 4	690 - 960 MHz 1710 - 2170 MHz 2300 - 2700 MHz Common			
Insertion loss	≤ 0.3 dB			
Isolation	≥ 60 dB			
Passive intermodulation (IM3) @ 2 x 20 W	≤ -155 dBc; typ. ≤ -160 dBc			
VSWR	≤ 1.25; typ. ≤ 1.2			
Power rating	≤ 300 W			
DC and AISG	1 A (all ports)			
Connectors	7-16 female		4.3-10 female	
Temperature range	-40 °C ... +60 °C			
Degree of protection (mated)	IP 67			
Weight	~ 3 kg	~ 6 kg	~ 3 kg	~ 6 kg
Mounting brackets	Included			



BN 570749

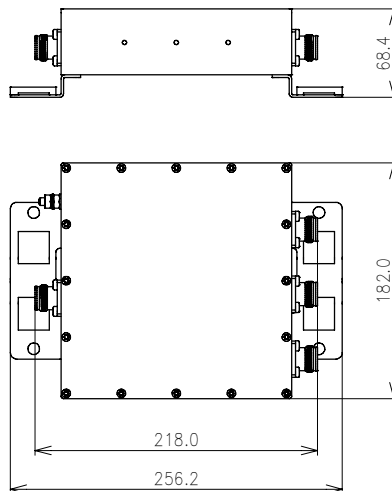

## Multiband Combiners

### Triplexers

Part Number	BN 570735	BN 570738	BN 570736	BN 570739	BN 570734	BN 570737
Version	Single	Double	Single	Double	Single	Double
Frequency range Port 1 Port 2 Port 3 Port 4	1710 - 1880 MHz 1920 - 2170 MHz 2500 - 2690 MHz Common					
Insertion loss Port 1 -> port 4 Port 2 -> port 4 Port 3 -> port 4	$\leq 0.4$ dB $\leq 0.45$ dB $\leq 0.5$ dB					
Isolation	$\geq 50$ dB					
Passive intermodulation (IM3) @ 2 x 20 W	$\leq -155$ dBc					
VSWR	$\leq 1.25$					
Power rating	$\leq 240$ W					
DC and AISG	1 A (port 1 -> port 4)		1 A (port 2 -> port 4)		1A (all ports)	
Connectors	4.3-10 female					
Temperature range	-25 °C ... +65 °C					
Degree of protection (mated)	IP 65					
Weight	~ 3.3 kg	~ 6.6 kg	~ 3.3 kg	~ 6.6 kg	~ 3.3 kg	~ 6.6 kg
Mounting brackets	Included					



BN 570734

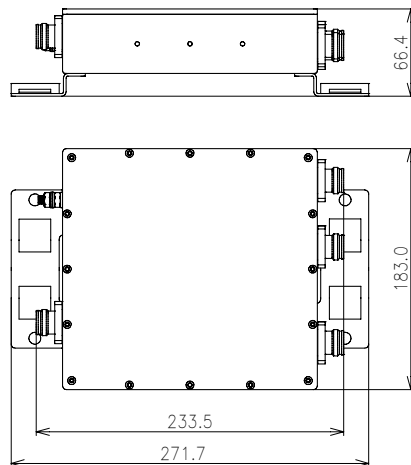

## Multiband Combiners



### Quadruplexers

Part Number	BN 570698	BN 570699	BN 570691	BN 570692
Version	Single	Double	Single	Double
Frequency range Port 1 Port 2 Port 3 Port 4 Port 5	694 - 960 MHz 1710 - 1880 MHz 1920 - 2170 MHz 2500 - 2690 MHz Common			
Insertion loss Port 1 -> port 5 Port 2 -> port 5 Port 3 -> port 5 Port 4 -> port 5	$\leq 0.2$ dB $\leq 0.4$ dB $\leq 0.5$ dB $\leq 0.3$ dB			
Isolation	$\geq 50$ dB			
Passive intermodulation (IM3) @ 2 x 20 W	$\leq -155$ dBc			
VSWR	$\leq 1.25$			
Power rating	$\leq 250$ W			
DC and AISG	3 A (port 4 -> port 5)		3 A (all ports)	
Connectors	7-16 female			
Temperature range	-40 °C ... +65 °C			
Degree of protection (mated)	IP 65			
Weight	~ 4.0 kg	~ 9.0 kg	~ 4.0 kg	~ 9.0 kg
Mounting brackets	Included			



BN 570691

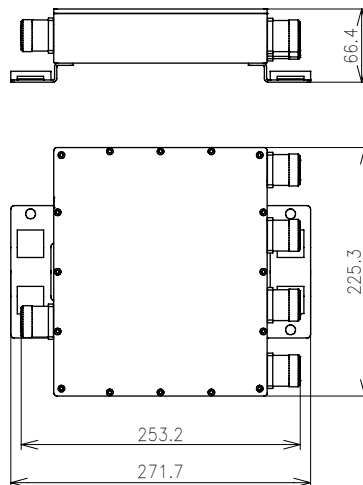

## Multiband Combiners



### Quadruplexers

Part Number	BN 572646	BN 572647	BN 572642	BN 572643
Version	Single	Double	Single	Double
Frequency range	Port 1 694 - 960 MHz Port 2 1710 - 1880 MHz Port 3 1920 - 2170 MHz Port 4 2500 - 2690 MHz Port 5 Common			
Insertion loss	Port 1 -> Port 5 ≤ 0.2 dB Port 2 -> Port 5 ≤ 0.4 dB Port 3 -> Port 5 ≤ 0.5 dB Port 4 -> Port 5 ≤ 0.3 dB			
Isolation	≥ 50 dB			
Passive intermodulation (IM3) @ 2 x 20 W	≤ -155 dBc			
VSWR	≤ 1.25			
Power rating	≤ 250 W			
DC and AISG	3 A (port 4 -> port 5)		3 A (all ports)	
Connectors	4.3-10 female			
Temperature range	-40 °C ... +65 °C			
Degree of protection (mated)	IP 65			
Weight	~ 4.0 kg	~ 9.0 kg	~ 4.0 kg	~ 9.0 kg
Mounting brackets	Included			



BN 572642

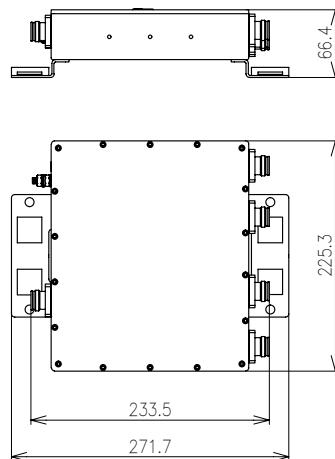

## Multiband Combiners



### Pentaplexers

Part Number	BN 572680
Version	Single
Frequency range	
Port 1	694 - 862 MHz
Port 2	880 - 960 MHz
Port 3	1710 - 1880 MHz
Port 4	1920 - 2170 MHz
Port 5	2500 - 2690 MHz
Port 6	Common
Insertion loss	≤ 0.5 dB
Isolation	≥ 50 dB
Passive intermodulation (IM3) @ 2 x 20 W	≤ -155 dBc
VSWR	≤ 1.25
Power rating	≤ 250 W
DC and AISG	3 A (all ports)
Connectors	4.3-10 female
Temperature range	-40 °C ... +65 °C
Degree of protection (mated)	IP 65
Weight	~ 8.0 kg
Mounting brackets	Included



**BN 572680**

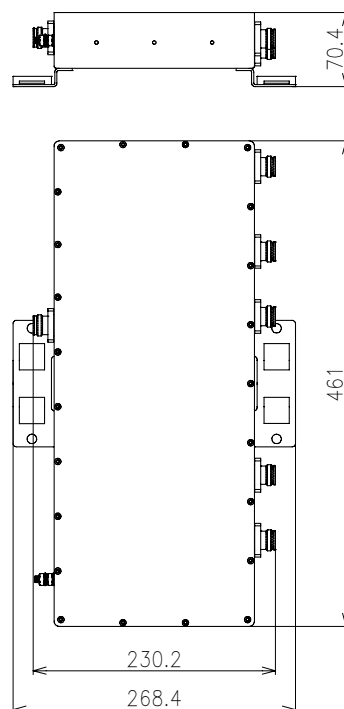

## Multiband Combiners

### Hexaplexer

Part Number	BN 572691	BN 572692
Version	Single	
Frequency range	Port 1                    694 - 870 MHz Port 2                    880 - 960 MHz Port 3                    1710 - 1880 MHz Port 4                    1920 - 2170 MHz Port 5                    2300 - 2400 MHz Port 6                    2500 - 2700 MHz Port 7                    Common Port 8                    Common monitoring port: -30 dB	
Insertion loss	Port 1,2 -> port 7                    ≤ 0.60 dB Port 3,4,5,6 -> port 7                ≤ 0.40 dB	
Isolation	≥ 50 dB	
Passive intermodulation (IM3) @ 2 x 20 W	≤ -155 dBc	
VSWR	≤ 1.25; typ. ≤ 1.2	
Power rating	≤ 250 W	
DC and AISG	N/A	1 A (all ports)
Connectors	7-16 female	
Temperature range	-25 °C ... +65 °C	
Degree of protection (mated)	IP 65	
Weight	~ 12.0 kg	
Mounting brackets	Included	



BN 572691

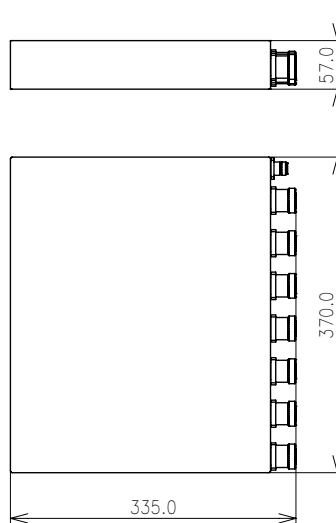



## Multiband Combining Systems



**SPINNER multiband combining systems are excellently suited for merging multiple operators with a number of different bands and/or carrier frequencies.**

### The appropriate solution for every requirement

SPINNER multiband combining systems have a wide variety of uses. Different types are available for small to midsized projects and for quickly and easily equipping business buildings, underground stations and shopping malls, to name just a few examples.

A large selection of systems with different numbers of inputs and outputs is available: 2:1, 3:3, 4:4, 6:3, 9:3, 12:3, 8:4, 12:4 and 16:4. These can be mounted in a 19" rack or on a wall. On request, we are also happy to supply a system to you in a sturdy box for outdoor installation.

### No operating cost

The principal advantages of these systems are: no operating cost, high flexibility, simple installation, and excellent technical properties.

All SPINNER multiband combining systems are completely passive and require no power supply, maintenance or network management. They also eliminate costs when services are discontinued. Once installed, a system runs reliably and fault-free. The broadband inputs also make it extremely flexible; for example, operator frequencies can be easily changed without tinkering with the system itself.





## Multiband Combining Systems

Frequency Range in MHz														
	350 - 475	694 - 788	791 - 862	876 - 960	1427 - 1518	1710 - 1880	1850 - 1990	1920 - 2170	2300 - 2400	2400 - 2500	2496 - 2690	3300 - 3800		
Examples														
	TETRA PMR	LTE700	LTE800	LTE900 GSM900 GSM-R	LTE1500 L-Band	GSM1800 LTE1800 AWS RX	PCS1900	UMTS AWS TX	LTE2300	WLAN	LTE2500 LTE2600	5G		
Type (input ports : output ports) – Style												Page		
<b>Broadband versions</b>														
2 : 1 - compact							2 inputs 350 - 2700 MHz						115	
2 : 1 - compact							2 inputs 694 - 2700 MHz						114 115	
2 : 1 - compact							2 inputs 694 - 3800 MHz						115	
3 : 3 - compact							3 inputs 380 - 3800 MHz						116	
3 : 3 - compact							3 inputs 694 - 2700 MHz						117 118	
4 : 4 - compact							4 inputs 350 - 2700 MHz						119	
4 : 4 - compact							4 inputs 380 - 3800 MHz						119	
4 : 4 - compact							4 inputs 694 - 3800 MHz						120	
4 : 4 - compact							4 inputs 694 - 2700 MHz						121	
<b>Optimized for combining 3 carriers with 2 bands each</b>														
6 : 3 - shelf	3 inputs 694 - 960 MHz						3 inputs 1710 - 2170 MHz						122	
6 : 3 - shelf	3 inputs 694 - 2170 MHz									3 inputs 2496 - 2690 MHz			122	
6 : 3 - shelf				3 inputs 1710 - 1880 MHz			3 inputs 1920 - 2170 MHz						122	
<b>Optimized for combining 3 carriers with 3 bands each</b>														
9 : 3 - shelf	3 inputs 694 - 960 MHz						3 inputs 1710 - 1880 MHz		3 inputs 1920 - 2170 MHz					123
<b>Optimized for combining 3 carriers with 4 bands each</b>														
12 : 3 - shelf	3 inputs 694 - 960 MHz						3 inputs 1710 - 1880 MHz		3 inputs 1920 - 2170 MHz		3 inputs 2500 - 2690 MHz			124
12 : 3 - box	3 inputs 694 - 960 MHz						3 inputs 1710 - 1880 MHz		3 inputs 1920 - 2170 MHz		3 inputs 2500 - 2690 MHz			125
<b>Optimized for combining 4 carriers with 2 bands each</b>														
8 : 4 - shelf	4 inputs 694 - 960 MHz						4 inputs 1710 - 2170 MHz						126	
8 : 4 - shelf	4 inputs 694 - 2170 MHz									4 inputs 2496 - 2690 MHz			126	
8 : 4 - shelf				4 inputs 1710 - 1880 MHz			4 inputs 1920 - 2170 MHz						126	
8 : 4 - box	4 inputs 694 - 960 MHz						4 inputs 1710 - 2170 MHz						127	
<b>Optimized for combining 4 carriers with 3 bands each</b>														
12 : 4 - shelf	4 inputs 694 - 960 MHz						4 inputs 1710 - 1880 MHz		4 inputs 1920 - 2170 MHz					128
12 : 4 - shelf							4 inputs 1710 - 1880 MHz		4 inputs 1920 - 2170 MHz		4 inputs 2500 - 2690 MHz			128
<b>Optimized for combining 4 carriers with 4 bands each</b>														
16 : 4 - shelf	4 inputs 694 - 960 MHz						4 inputs 1710 - 1880 MHz		4 inputs 1920 - 2170 MHz		4 inputs 2500 - 2690 MHz			129
16 : 4 - box	4 inputs 694 - 960 MHz						4 inputs 1710 - 1880 MHz		4 inputs 1920 - 2170 MHz		4 inputs 2500 - 2690 MHz			130
<b>Optimized for combining 4 carriers with 5 bands each</b>														
20 : 4 - shelf	4 inputs 694 - 960 MHz						4 inputs 1710 - 1880 MHz		4 inputs 1920 - 2170 MHz		4 inputs 2500 - 2690 MHz		4 inputs 3300 - 3800 MHz	131

## Multiband Combining Systems

### 2 : 1 (Hybrid) Combiners Compact Version

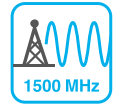

Part Number	BN 573645	BN 753367
Version (input : output)	2 : 1	
Frequency range	694 - 2700 MHz	
Insertion loss	3.0 dB ± 0.5 dB	
Isolation	≥ 30 dB	
Passive intermodulation (IM3) @ 2 x 20 W	≤ -155 dBc; typ. ≤ -160 dBc	
VSWR	≤ 1.15	
Power rating	≤ 100 W	
Connectors	7-16 female	4.3-10 female
Temperature range	-40 °C ... +55 °C	
Degree of protection (mated)	IP 68	
Weight	~ 4.0 kg	
Mounting brackets	Included	



BN 573645

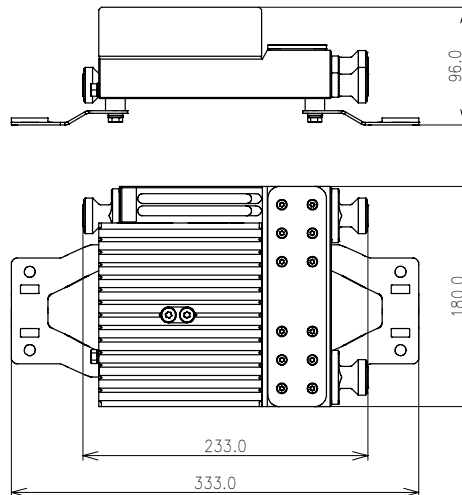

## Multiband Combining Systems

2 : 1 (Hybrid) Combiners  
Compact Version

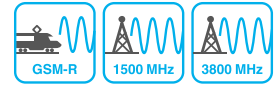
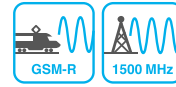

Part Number	BN 753388	BN 753373	BN 753374
Version (input : output)	2 : 1		
Frequency range	350 - 2700 MHz	694 - 2700 MHz	694 - 3800 MHz
Insertion loss	3.0 dB ± 0.9 dB	3.0 dB ± 0.6 dB	
Isolation	≥ 23 dB		≥ 23 dB @ 694 - 2700 MHz ≥ 20 dB @ 2700 - 3800 MHz
Passive intermodulation (IM3) @ 2 x 20 W	≤ 140 dBc @ 350 - 694 MHz ≤ 150 dBc @ 694 - 2700 MHz	≤ 150 dBc @ 694 - 800 MHz ≤ 155 dBc @ 800 - 3000 MHz	
VSWR	≤ 1.25		
Power rating	≤ 80 W		
Connectors	4.3-10 female		
Temperature range	-40 °C ... +50 °C		
Degree of protection (mated)	IP 65		
Weight	~ 3.7 kg	~ 3.5 kg	
Mounting brackets	Included		



BN 753373

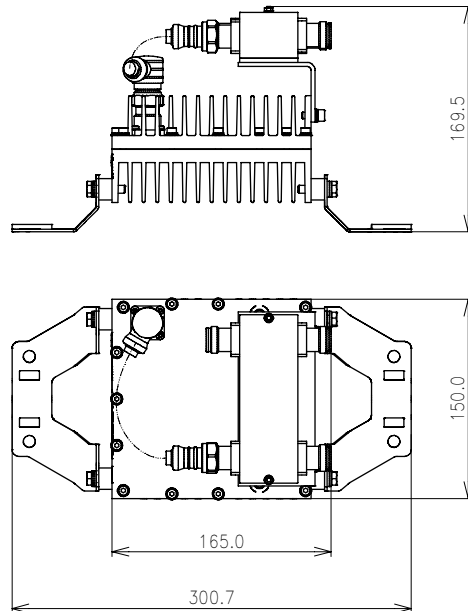

## Multiband Combining Systems

3 : 3 Combiners  
Compact Version

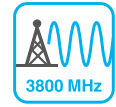
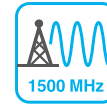
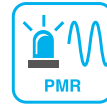

<b>Part Number</b>	<b>BN 570754</b>
Version (input : output)	3 : 3
Frequency range	380 - 3800 MHz
Insertion loss	5.0 dB ± 1.2 dB
Isolation	≥ 28 dB; typ. ≥ 30 dB
Passive intermodulation (IM3) @ 2 x 20 W	≤ -160 dBc; typ. ≤ -165 dBc
VSWR	≤ 1.25
Power rating	≤ 500 W
Connectors	4.3-10 female
Temperature range	-40 °C ... +55 °C
Degree of protection (mated)	IP 65
Weight	~ 6.6 kg
Mounting brackets	Included



**BN 570754**

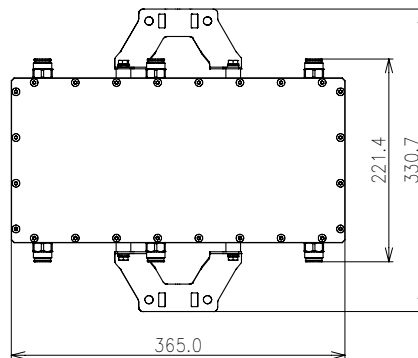

## Multiband Combining Systems

3 : 3 Combiners  
Compact Version

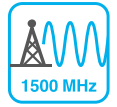

Part Number	BN 570633	BN 570635
Version (input : output)	3 : 3	
Frequency range	694 - 2700 MHz	
Insertion loss Port 1,2,3 -> port 4,5 Port 1,2,3 -> port 6	5.0 dB ± 0.8 dB 5.0 dB ± 1.2 dB	
Isolation	≥ 30 dB	
Passive intermodulation (IM3) @ 2 x 20 W	≤ -160 dBc; typ. ≤ -165 dBc	
VSWR	≤ 1.20	
Power rating	≤ 500 W	
Connectors	7-16 female	4.3-10 female
Temperature range	-40 °C ... +70 °C	
Degree of protection (mated)	IP 65	
Weight	~ 5.0 kg	
Mounting brackets	Included	



BN 570635

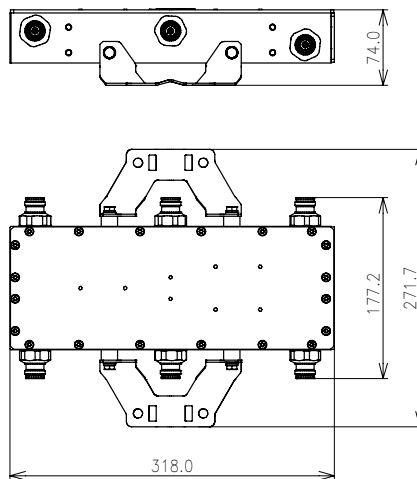

## Multiband Combining Systems

3 : 3 Combiners  
Compact Version

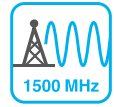

Part Number	BN 570684	BN 570685	BN 570733
Version (input : output)	3 : 3		
Frequency range	694 - 2700 MHz		
Insertion loss	5.0 dB ± 1.3 dB		
Isolation	≥ 23 dB		
Passive intermodulation (IM3) @ 2 x 20 W	≤ -155 dBc; typ. ≤ -160 dBc		
VSWR	≤ 1.25		
Power rating	≤ 200 W		
Connectors	7-16 female	4.3-10 female	N female
Temperature range	-30 °C ... +65 °C		
Degree of protection (mated)	IP 65		
Weight	~ 2.6 kg	~ 2.0 kg	~ 1.6 kg
Mounting brackets	Included		



BN 570685

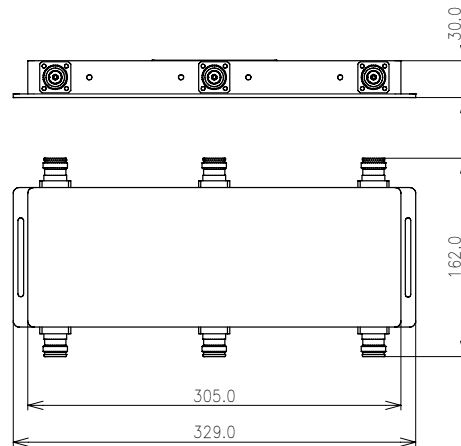

## Multiband Combining Systems

4 : 4 Combiners  
Compact Version

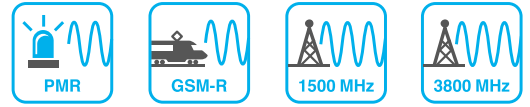

Part Number	BN 570680	BN 570680F001	BN 570755
Version (input : output)	4 : 4		
Frequency range	350 - 2700 MHz		380 - 3800 MHz
Insertion loss	6.0 dB $\pm$ 1.5 dB		6.1 dB $\pm$ 1.2 dB
Isolation	$\geq$ 23 dB		$\geq$ 28 dB; typ. $\geq$ 30 dB
Passive intermodulation (IM3) @ 2 x 20 W	$\leq$ -155 dBc	$\leq$ -160 dBc; typ. $\leq$ -165 dBc	
VSWR	$\leq$ 1.25; typ. $\leq$ 1.2		$\leq$ 1.25
Power rating	$\leq$ 400 W		$\leq$ 500 W
Connectors	4.3-10 female		
Temperature range	-25 °C ... +65 °C		-40 °C ... +55 °C
Degree of protection (mated)	IP 65		
Weight	~ 3.6 kg		~ 6.2 kg
Mounting brackets	Included		



BN 570680

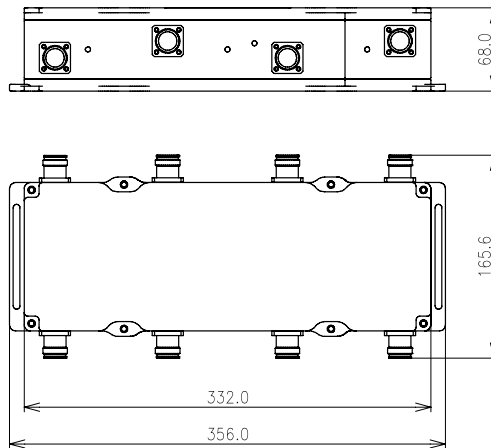

## Multiband Combining Systems

4 : 4 Combiners  
Compact Version

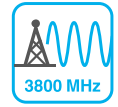
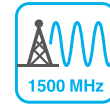

Part Number	BN 570682	BN 570741	BN 570681	BN 570683
Version (input : output)	4 : 4			
Frequency range	694 - 3800 MHz			
Insertion loss	6.1 dB ± 1.4 dB			
Isolation	≥ 23 dB	≥ 30 dB	≥ 23 dB	
Passive intermodulation (IM3) @ 2 x 20 W	≤ -155 dBc	≤ -160 dBc; typ. ≤ -165 dBc	≤ -155 dBc	
VSWR	≤ 1.3	≤ 1.2	≤ 1.3	
Power rating	≤ 500 W		≤ 400 W	≤ 200 W
Connectors	7-16 female	4.3-10 female		N female
Temperature range	-40 °C ... +65 °C			
Degree of protection (mated)	IP 65			
Weight	~ 2.4 kg	~ 10,0 kg	~ 2.1 kg	~ 1.9 kg
Mounting brackets	Included			



BN 570741

BN 570681

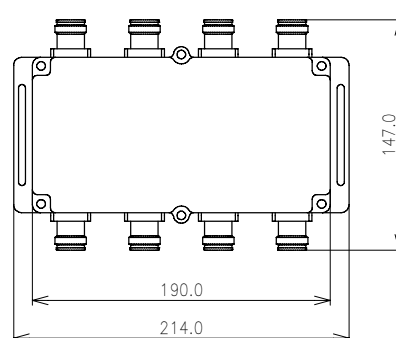
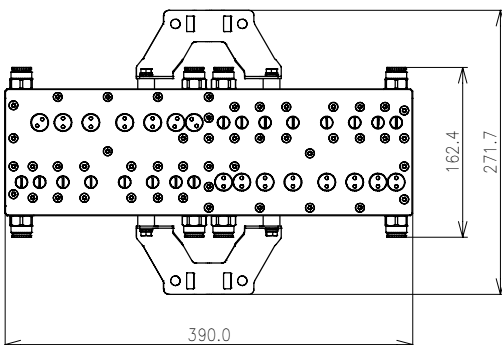
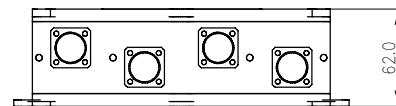
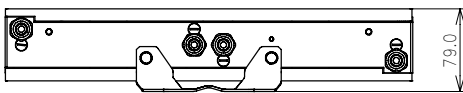



## Multiband Combining Systems

4 : 4 Combiners  
Compact Version

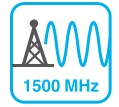

Part Number	BN 570538	BN 570634	BN 570742	BN 570657	BN 570656
Version (input : output)	4 : 4				
Frequency range	694 - 2700 MHz				
Insertion loss	6.1 dB ± 0.9 dB		6.1 dB ± 1.0 dB	6.1 dB ± 0.9 dB	6.1 dB ± 1.2 dB
Isolation	≥ 30 dB; typ. ≥ 32 dB		≥ 25 dB; typ. ≥ 30 dB	≥ 30 dB; typ. ≥ 32 dB	≥ 25 dB
Passive intermodulation (IM3) @ 2 x 20 W	≤ -160 dBc; typ. ≤ -165 dBc			≤ -155 dBc; typ. ≤ -160 dBc	≤ -150 dBc
VSWR	≤ 1.12		≤ 1.25; typ. 1.15	≤ 1.12	≤ 1.25
Power rating	≤ 500 W		≤ 200 W	≤ 250 W	≤ 200 W
Connectors	7-16 female		4.3-10 female		N female
Temperature range	-40 °C ... +70 °C		-30 °C ... +65 °C	-40 °C ... +70 °C	-30 °C ... +55 °C
Degree of protection (mated)	IP 65				
Weight	~ 5.5 kg			~ 3.0 kg	
Mounting brackets	Included				



BN 570634

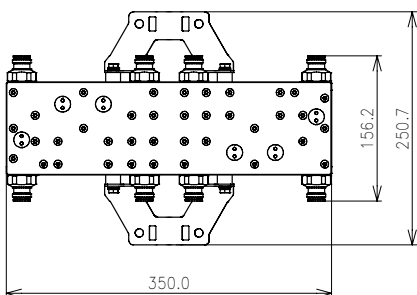

BN 570742

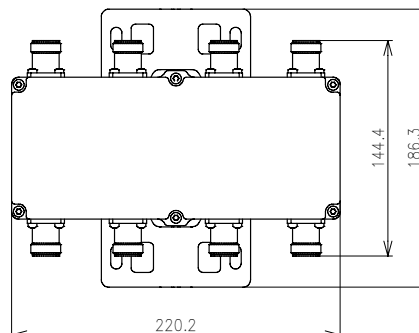
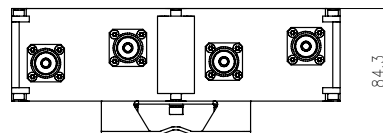

## Multiband Combining Systems

6 : 3 Combiners  
Indoor Shelf for 19" Rack or Wall Mounting

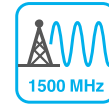

Part Number	BN 610633	BN 572681	BN 610632	BN 572682	BN 610634	BN 572683
Version (input : output)	6 : 3 (3 inputs per band)					
Frequency range	694 - 960 MHz 1710 - 2170 MHz		694 - 2170 MHz 2496 - 2690 MHz		1710 - 1880 MHz 1920 - 2170 MHz	
Insertion loss	5.35 dB ± 0.8 dB		5.55 dB ± 0.8 dB		5.65 dB ± 0.8 dB	
Isolation interband	≥ 50 dB					
Isolation intraband	≥ 30 dB					
Passive intermodulation (IM3) @ 2 x 20 W	≤ -155 dBc; typ. ≤ -160 dBc					
VSWR	≤ 1.40; typ. ≤ 1.25					
Power rating	≤ 200 W					
Connectors	7-16 female	4.3-10 female	7-16 female	4.3-10 female	7-16 female	4.3-10 female
Temperature range	-40 °C ... +65 °C					
Degree of protection (mated)	IP 65					
Weight	~ 10 kg			~ 17 kg		
Mounting brackets	Included					



BN 610633

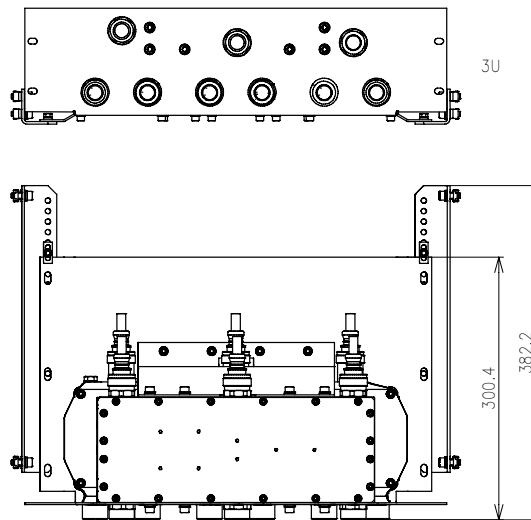

## Multiband Combining Systems



9 : 3 Combiners  
Indoor Shelf for 19" Rack or Wall Mounting

Part Number	BN 610635	BN 572684
Version (input : output)	9 : 3 (3 inputs per band)	
Frequency range	Band 1 694 - 960 MHz Band 2 1710 - 1880 MHz Band 3 1920 - 2170 MHz	
Insertion loss	5.65 dB ± 0.8 dB	
Isolation interband	≥ 50 dB	
Isolation intraband	≥ 30 dB	
Passive intermodulation (IM3) @ 2 x 20 W	≤ -155 dBc; typ. ≤ -160 dBc	
VSWR	≤ 1.40; typ. ≤ 1.25	
Power rating	≤ 130 W	
Connectors	7-16 female	4.3-10 female
Temperature range	-40 °C ... +65 °C	
Degree of protection (mated)	IP 65	
Weight	~ 19 kg	
Mounting brackets	Included	



BN 610635

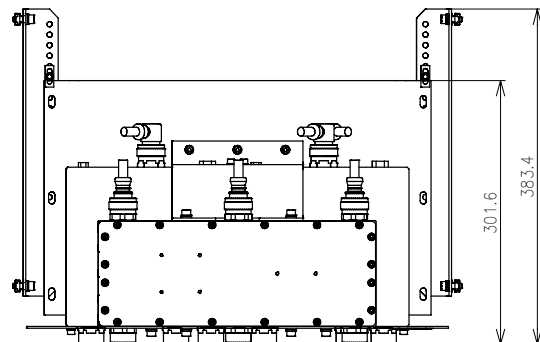
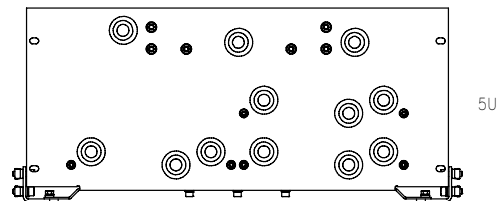

## Multiband Combining Systems

12 : 3 Combiners  
Indoor Shelf for 19" Rack or Wall Mounting



Part Number	BN 610631	BN 572661
Version (input : output)	12 : 3 (3 inputs per band)	
Frequency range	Band 1 694 - 960 MHz Band 2 1710 - 1880 MHz Band 3 1920 - 2170 MHz Band 4 2500 - 2690 MHz	
Insertion loss	5.75 dB ± 0.8 dB	
Isolation interband	≥ 50 dB	
Isolation intraband	≥ 30 dB	
Passive intermodulation (IM3) @ 2 x 20 W	≤ -155 dBc; typ. ≤ -160 dBc	
VSWR	≤ 1.40; typ. ≤ 1.25	
Power rating	≤ 125 W	
Connectors	7-16 female	4.3-10 female
Temperature range	-40 °C ... +60 °C	
Degree of protection (mated)	IP 65	
Weight	~ 21 kg	
Mounting brackets	Included	



BN 572661

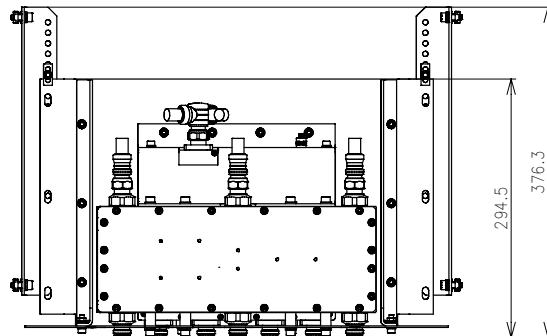
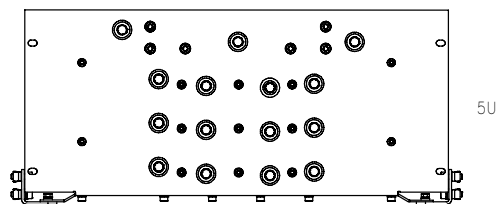

## Multiband Combining Systems

12 : 3 Combiners  
Outdoor Box



Part Number	BN 610630	BN 572660
Version (input : output)	12 : 3 (3 inputs per band)	
Frequency range	Band 1 694 - 960 MHz Band 2 1710 - 1880 MHz Band 3 1920 - 2170 MHz Band 4 2500 - 2690 MHz	
Insertion loss	5.70 dB ± 1.2 dB	
Isolation interband	≥ 50 dB	
Isolation intraband	≥ 30 dB	
Passive intermodulation (IM3) @ 2 x 20 W	≤ -155 dBc; typ. ≤ -160 dBc	
VSWR	≤ 1.40; typ. ≤ 1.25	
Power rating	≤ 125 W	
Connectors	7-16 female	4.3-10 female
Temperature range	-40 °C ... +60 °C	
Degree of protection (mated)	IP 65	
Weight	~ 25 kg	
Mounting brackets	Included	



BN 610630

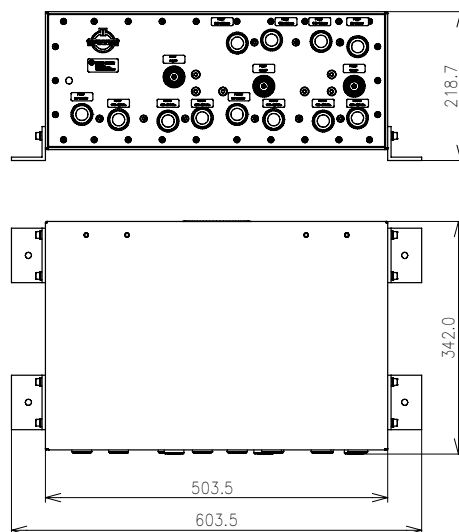

## Multiband Combining Systems

8 : 4 Combiners  
Indoor Shelf for 19" Rack or Wall Mounting

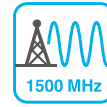

Part Number	BN 610649	BN 572685	BN 610652	BN 572687	BN 610650	BN 572688
Version (input : output)	8 : 4 (4 inputs per band)					
Frequency range	694 - 960 MHz 1710 - 2170 MHz		694 - 2170 MHz 2496 - 2690 MHz		1710 - 1880 MHz 1920 - 2170 MHz	
Insertion loss	6.45 dB ± 0.9 dB		6.65 dB ± 0.9 dB		6.75 dB ± 0.9 dB	
Isolation interband	≥ 50 dB					
Isolation intraband	≥ 30 dB					
Passive intermodulation (IM3) @ 2 x 20 W	≤ -155 dBc; typ. ≤ -160 dBc					
VSWR	≤ 1.40; typ. ≤ 1.25					
Power rating	≤ 200 W					
Connectors	7-16 female	4.3-10 female	7-16 female	4.3-10 female	7-16 female	4.3-10 female
Temperature range	-40 °C ... +65 °C					
Degree of protection (mated)	IP 65					
Weight	~ 12 kg		~ 21 kg			
Mounting brackets	Included					



BN 610649

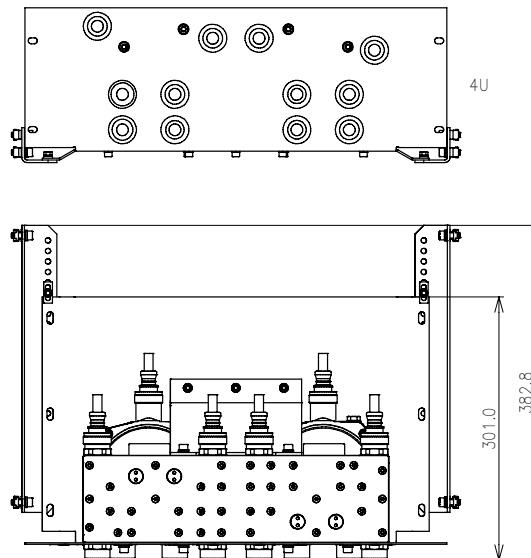

## Multiband Combining Systems



8 : 4 Combiners  
Outdoor Box

Part Number	BN 570690	BN 572686
Version (input : output)	8 : 4 (4 inputs per band)	
Frequency range	694 - 960 MHz 1710 - 2170 MHz	
Band 1 Band 2		
Insertion loss	6.45 dB ± 0.9 dB	
Isolation interband	≥ 50 dB	
Isolation intraband	≥ 30 dB	
Passive intermodulation (IM3) @ 2 x 20 W	≤ -155 dBc; typ. ≤ -160 dBc	
VSWR	≤ 1.40; typ. ≤ 1.25	
Power rating	≤ 250 W	
Connectors	7-16 female	4.3-10 female
Temperature range	-40 °C ... +65 °C	
Degree of protection (mated)	IP 65	
Weight	~ 17 kg	
Mounting brackets	Included	



BN 570690

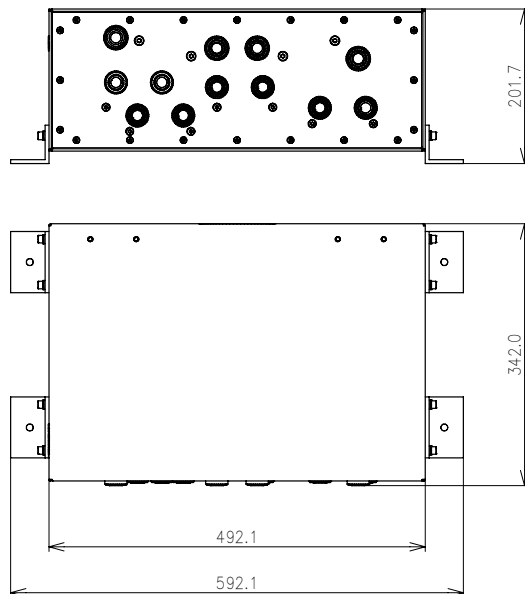

## Multiband Combining Systems

12 : 4 Combiners  
Indoor Shelf for 19" Rack or Wall Mounting



Part Number	BN 610651	BN 572689	BN 572679
Version (input : output)	12 : 4 (4 inputs per band)		
Frequency range	Band 1 694 - 960 MHz Band 2 1710 - 1880 MHz Band 3 1920 - 2170 MHz		1710 - 1880 MHz 1920 - 2170 MHz 2500 - 2690 MHz
Insertion loss	6.75 dB ± 0.9 dB		6.70 dB ± 0.6 dB
Isolation interband	≥ 50 dB		
Isolation intraband	≥ 30 dB		
Passive intermodulation (IM3) @ 2 x 20 W	≤ -155 dBc; typ. ≤ -160 dBc		
VSWR	≤ 1.40; typ. ≤ 1.25		
Power rating	≤ 130 W		≤ 100 W
Connectors	7-16 female	4.3-10 female	
Temperature range	-40 °C ... +65 °C		
Degree of protection (mated)	IP 65		
Weight	~ 24 kg		~ 25 kg
Mounting brackets	Included		



BN 610651

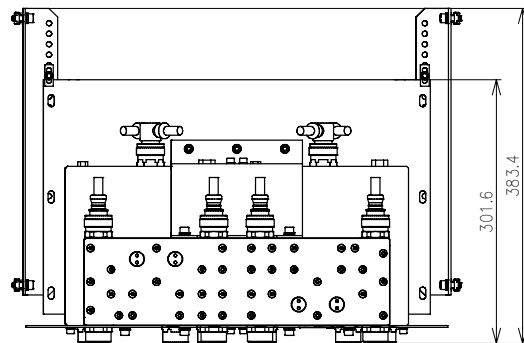
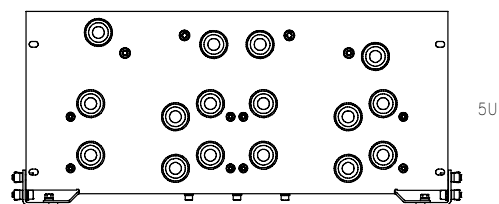



## Multiband Combining Systems



16 : 4 Combiners  
Indoor Shelf for 19" Rack or Wall Mounting

Part Number	BN 610648	BN 572663
Version (input : output)	16 : 4 (4 inputs per band)	
Frequency range	Band 1 694 - 960 MHz Band 2 1710 - 1880 MHz Band 3 1920 - 2170 MHz Band 4 2500 - 2690 MHz	
Insertion loss	6.85 dB ± 0.9 dB	
Isolation interband	≥ 50 dB	
Isolation intraband	≥ 30 dB	
Passive intermodulation (IM3) @ 2 x 20 W	≤ -155 dBc; typ. ≤ -160 dBc	
VSWR	≤ 1.40; typ. ≤ 1.25	
Power rating	≤ 125 W	
Connectors	7-16 female	4.3-10 female
Temperature range	-40 °C ... +60 °C	
Degree of protection (mated)	IP 65	
Weight	~ 26 kg	
Mounting material	Included	



BN 572663

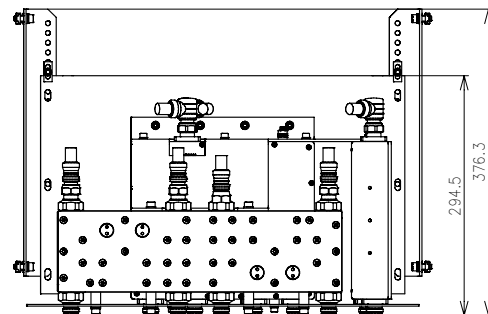
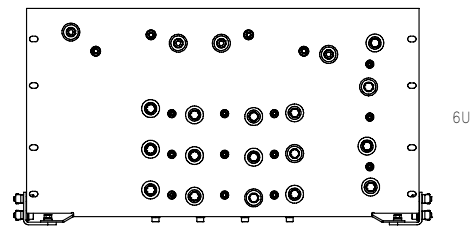

## Multiband Combining Systems

16 : 4 Combiners  
Outdoor Box



Part Number	BN 610647	BN 572662
Version (input : output)	16 : 4 (4 inputs per band)	
Frequency range	Band 1 694 - 960 MHz Band 2 1710 - 1880 MHz Band 3 1920 - 2170 MHz Band 4 2500 - 2690 MHz	
Insertion loss	Band 1 6.5 dB ± 0.90 dB Band 2 6.7 dB ± 0.60 dB Band 3 6.8 dB ± 0.60 dB Band 4 6.6 dB ± 0.60 dB	
Isolation interband	≥ 50 dB	
Isolation intraband	≥ 30 dB	
Passive intermodulation (IM3) @ 2 x 20 W	≤ -155 dBc; typ. ≤ -160 dBc	
VSWR	≤ 1.40; typ. ≤ 1.25	
Power rating	≤ 125 W	
Connectors	7-16 female	4.3-10 female
Temperature range	-40 °C ... +65 °C	
Degree of protection (mated)	IP 65	
Weight	~ 32 kg	
Mounting brackets	Included	



BN 572662

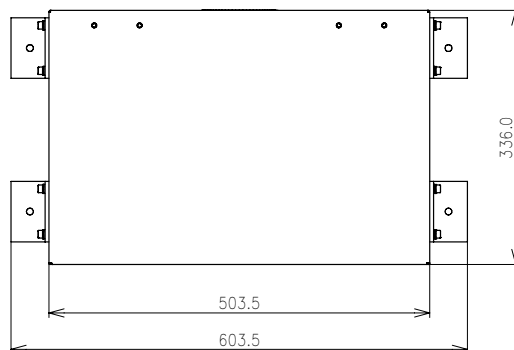
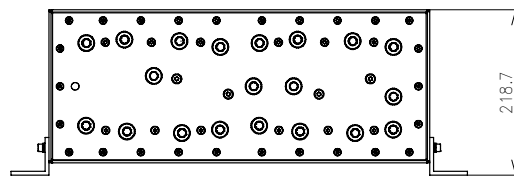

## Multiband Combining Systems

20 : 4 Combiners  
Indoor Shelf for 19" Rack or Wall Mounting



Part Number	BN 572690
Version (input : output)	20 : 4 (5 inputs per band)
Frequency range	Band 1 694 - 960 MHz Band 2 1710 - 1880 MHz Band 3 1920 - 2170 MHz Band 4 2500 - 2690 MHz Band 5 3300 - 3800 MHz
Insertion loss	7.20 dB ± 1.0 dB
Isolation interband	≥ 50 dB
Isolation intraband	≥ 30 dB
Passive intermodulation (IM3) @ 2 x 20 W	≤ -155 dBc; typ. ≤ -160 dBc
VSWR	≤ 1.40; typ. ≤ 1.25
Power rating	Band 1 – 4 ≤ 75 W Band 5 ≤ 60 W
Connectors	4.3-10 female
Temperature range	-40 °C ... +60 °C
Degree of protection (mated)	IP 65
Weight	~ 60 kg
Mounting material	Included

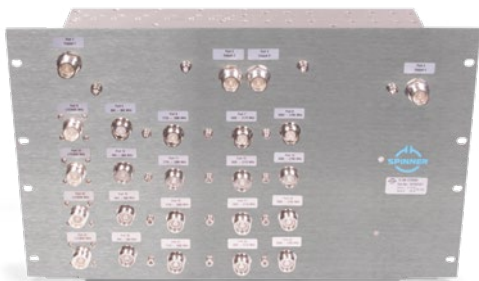

BN 572690

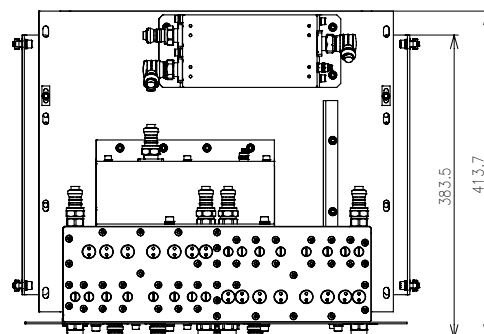
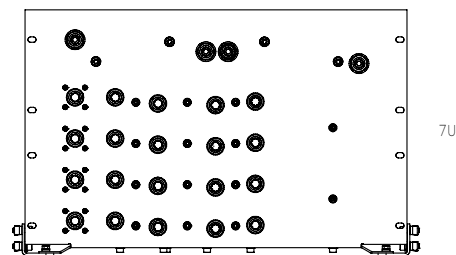

## Sameband Combiners



Sameband combiners enable antenna and feeder sharing for two or more base stations in the same frequency band. For this purpose, the transmitted and received signals of base stations are separated and the corresponding signals are combined via band-pass filter and star points. SPINNER sameband combiners stand out for low insertion loss, high isolation between frequency blocks and extremely low intermodulation.

We offer a wide range of sameband combiners for all mobile networks ranging from LTE700 to LTE2600. The bandwidths can be tuned between 4 and 20 MHz. Sameband combiners with a larger number of circuits (cavities) grant a greater isolation within the stopbands. In conjunction with this the passband attenuation increases. Please let us know your requirements so we can suggest the best possible solution.

All sameband combiners need to be customized to individual customer needs. The products for which this service is required are designated in our catalog by the logo shown below.



The technical data given for the insertion loss, isolation and VSWR depend on the individual tuning. Before you place your order, we send you a binding quotation indicating the specified technical data and measurement curves. To request a quotation for customized filters for your applications, please contact us at [info@spinner-group.com](mailto:info@spinner-group.com).

## Sameband Combiners



### LTE700 | LTE800 | GSM900

Part Number	BN 570531	BN 570561	BN 570627	BN 570630	BN 570662	BN 570673	BN 570626	BN 570631	BN 570663	BN 570643
Version	Single	Double	Single	Double	Single	Double	Single	Double	Single	Double
Cavities	4			6		4		6		
Frequency range	LTE700			LTE800			GSM900			
Insertion loss	Depending on tuning									
Isolation	Depending on tuning									
Passive intermodulation (IM3) @ 2 x 20 W	≤ -150 dBc; typ. ≤ -160 dBc									
VSWR	Depending on tuning									
Power rating	≤ 100 W									
Connectors	7-16 female									
Temperature range	-5 °C ... +65 °C									
Degree of protection (mated)	IP 65									
Weight	~ 6.7 kg	~ 13.0 kg	~ 6.7 kg	~ 13.0 kg	~ 9.2 kg	~ 20.0 kg	~ 6.7 kg	~ 13.0 kg	~ 9.2 kg	~ 20.0 kg
Mounting brackets	Included									

Further sameband combiners on request.



### GSM1800 | UMTS | LTE2600

Part Number	BN 570611	BN 570614	BN 570665	BN 570644	BN 570612	BN 570615	BN 570613	BN 570616	BN 570752	BN 570753
Version	Single	Double	Single	Double	Single	Double	Single	Double	Single	Double
Cavities	4		6		4			6		
Frequency range	GSM1800				UMTS		LTE2600		LTE3800	
Insertion loss	Depending on tuning									
Isolation	Depending on tuning									
Passive intermodulation (IM3) @ 2 x 20 W	≤ -150 dBc; typ. ≤ -160 dBc									
VSWR	Depending on tuning									
Power rating	≤ 100 W									
Connectors	7-16 female									
Temperature range	-5 °C ... +65 °C									
Degree of protection (mated)	IP 65									
Weight	~ 6.3 kg	~ 13.0 kg	~ 9.2 kg	~ 20.0 kg	~ 6.7 kg	~ 13.0 kg	~ 6.7 kg	~ 13.0 kg	~ 6.0 kg	~ 12.0 kg
Mounting brackets	Included									

Further sameband combiners on request.

## Mobile Network Combining System (MNCS®)



The Mobile Network Combining System (MNCS®) from SPINNER is an In-Building solution for combining a large number of bands and carrier frequencies of one or more operators and distributing them via a Distributed Antenna System (DAS).

It is especially useful whenever it is not possible to achieve a satisfactory solution by linking together conventional multiband or sameband combiners.

This applies especially if:

- The carrier frequencies within a band are very close together.
  - The isolation requirement is very high (> 50 dB).
  - It is necessary to maximize bandwidth use.
  - Multiple operators will share the same In-Building solution.
- If at least one of these statements holds true, MNCS® is ideal.

### What Exactly Is MNCS®?

Every SPINNER MNCS® system is a custom-configured In-Building/DAS solution in which a large number of frequency bands and carrier frequencies are combined. It has an appropriate number of outputs for the sectors that are fed into it.

The MNCS® doesn't simply combine an array of individual components on a rack. Instead, it is a solution in which the components are specially selected, assembled and connected to meet the customer's particular needs. The components are planned and harmonized with utmost care to make sure that you benefit from the greatest possible bandwidth and isolation with minimal susceptibility to interference. The likelihood of interference increases greatly as the number of frequencies used in a system rises

(see page 6). To manage this, we only use components with extremely low intermodulation and design the transitions and wiring to minimize PIM. This approach enables us to develop virtually interference-free systems with an intermodulation value below -160 dBc.

### Who Uses MNCS®?

The uses for MNCS® systems are diverse, ranging from simple single-operator campus solutions all the way to complex multi-operator systems at airports, fairgrounds, subway and rapid transit stations with tunnels, governmental and office buildings, stadiums, hotels, shopping malls etc. Every facility in which many people use mobile services within a clearly bounded space is a potential candidate for a SPINNER MNCS® In-Building solution. It doesn't matter whether the system is planned by one or multiple operators. If there is more than one, SPINNER is happy to assume the role of coordinator during the planning phase in order to reconcile their needs.



Small indoor MNCS® rack

## Mobile Network Combining System (MNCS®)

### The Benefits of SPINNER's MNCS®

At SPINNER we are committed to supplying technical solutions with the best possible performance. This naturally also applies to the SPINNER MNCS® system. When planning and bidding for In-Building projects, many criteria and factors need to be taken into account to choose the most appropriate solution. The possibilities cover a wide range, from a simple multiband combining system all the way to extremely complex setups. Every project and implementation is different and has to be very thoughtfully considered on its own merits in order to weigh the pros and cons of the available alternatives. Based on experience gained from more than 1000 successfully completed In-Building projects, you can count on a SPINNER system to deliver the following benefits:

We would be very happy to have the opportunity to help you successfully implement an In-Building project. In order to make you a nonbinding offer with no further obligation on your part, we require information on all planned frequency bands and carriers and the structure of the antenna distribution system for all involved operators.

#### Benefits:

- Cost savings, since no expensive active components are used.
- No OPEX, because the solution is exclusively passive and can dispense with cooling systems.
- No follow-up CAPEX for operation, which can be the case with active systems when components fail or are discontinued.
- Low space requirements in equipment rooms.
- Unproblematic outdoor setup installation, even in the harshest climatic conditions, since all components are suitable for outside use.
- Flexible scalability, since the system is modular and easy to expand at any time. This also applies to adding new bands, carriers and operators.
- Low installation costs, since the system is supplied completely assembled and tested.



Small wall-mount MNCS® racks



Midsized indoor MNCS® system



Large outdoor MNCS® system on a building roof

## Products for Distributed Antenna System (DAS)



It is becoming increasingly important to ensure good mobile connectivity inside complexes such as office buildings, shopping malls, stadiums, airports and so on. Multiple network operators and frequencies have to be combined, distributed, and broadcast by appropriate antennas in the buildings.

### Covering all bands

A wide range of requirements have to be met for this. The communication standards and systems involved can extend from TETRA across GSM, UMTS, PCS/AWS and LTE to seamless Wi-Fi. Depending on local conditions, a variety of different components may have to be used for branching signals from the trunk line to the antennas.

Whenever many frequencies are carried by a shared cable, there is a risk of passive intermodulation (see page 6). The main drawbacks of this are, on the one hand, considerably greater installation and/or maintenance costs to cope with transmission problems and, on the other, reduced bandwidth use, which translates into a less than optimal return on the investment.

SPINNER avoids these problems by developing high-quality, low-intermodulation components. The following products, some of which boast a very large bandwidth, are available for distributing signals:

**Symmetrical splitters** (power splitters) divide an incoming signal into several equal parts.

**Asymmetrical splitters** (taps) divide an incoming signal into parts of different sizes based on fixed proportions.

**Directional couplers** make it possible to split an incoming signal into two equal or unequal parts with excellent isolation. A directional coupler can also be used in reverse to mix two incoming signals, even if they have different frequencies (it is then referred to as a hybrid coupler).





## Distributing Products

Frequency Range in MHz															
	350 - 475	694 - 788	791 - 862	876 - 960	1427 - 1518	1710 - 1880	1850 - 1990	1920 - 2170	2300 - 2400	2400 - 2500	2496 - 2690	3300 - 3800			
Examples															
	TETRA PMR	LTE700	LTE800	LTE900 GSM900 GSM-R	LTE1500 L-Band	GSM1800 LTE1800 AWS RX	PCS1900	UMTS AWS TX	LTE2300	WLAN	LTE2500 LTE2600	5G			
Product Style – Connectors													Page		
<b>Symmetric Splitters</b>															
Star - 7-16													330 - 2700 MHz	138	
Star - 4.3-10														330 - 2700 MHz	139
Star - N														330 - 2700 MHz	140
Star - 4.3-10														350 - 3800 MHz	141
In line - 4.3-10														694 - 3800 MHz	142
In line - 4.3-10														694 - 2700 MHz	143
In line - N														694 - 2700 MHz	143
Star - 7-16														694 - 3800 MHz	144
Star - 4.3-10														694 - 3800 MHz	145
Star - N														694 - 3800 MHz	146
Star - 7-16				870 - 960 MHz											147
<b>Asymmetric Splitters</b>															
Tapper - 7-16			170 - 1500 MHz											1710 - 2700 MHz	148
Tapper - 4.3-10			170 - 1500 MHz											1710 - 2700 MHz	149
Tapper - N			170 - 1500 MHz											1710 - 2700 MHz	150
Tapper - 4.3-10														380 - 3800 MHz	151
Coupler - 7-16														350 - 3800 MHz	152
Coupler - 4.3-10														350 - 3800 MHz	153
Tapper - 4.3-10														690 - 2170 MHz	154
Coupler - 7-16														2300 - 3800 MHz	155
Coupler - 4.3-10														694 - 2700 MHz	156
Coupler - N														694 - 2700 MHz	157
<b>Directional Couplers</b>															
H - 7-16	330 - 520 MHz														158
X - 7-16														350 - 2700 MHz	159
X - 4.3-10														350 - 2700 MHz	159
X - N														350 - 2700 MHz	159
X - 7-16														694 - 3800 MHz	160
X - 4.3-10														694 - 3800 MHz	160
H - 7-16														694 - 2700 MHz	161
H - 4.3-10														694 - 2700 MHz	162
H - N														694 - 2700 MHz	161
X - 7-16														694 - 2700 MHz	161
H - 4.3-10 (unidir.)														694 - 2700 MHz	164
X - 4.3-10														694 - 2700 MHz	162
X - N														694 - 2700 MHz	164

## Symmetric Splitters

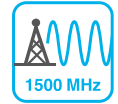
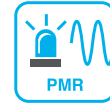

330 - 2700 MHz

Part Number	BN 818289	BN 818290	BN 818291
Version (outputs)	2	3	4
Frequency range	330 - 2700 MHz		
Insertion loss	≤ 3.2 dB	≤ 5.0 dB	≤ 6.5 dB
Passive intermodulation (IM3) @ 2 x 20 W	≤ -160 dBc		
VSWR	≤ 1.2		
Power rating	≤ 450 W		
Connectors	7-16 female		
Temperature range	-40 °C ... +75 °C		
Degree of protection (mated)	IP68		
Weight	~ 1.1 kg	~ 1.1 kg	~ 1.2 kg
Mounting brackets	Included		



BN 818289



BN 818290



BN 818291

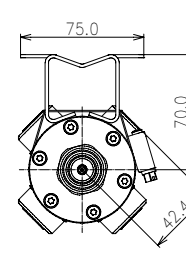
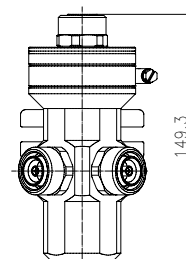
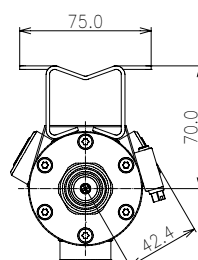
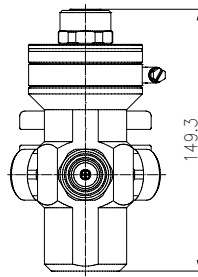
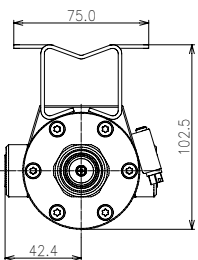
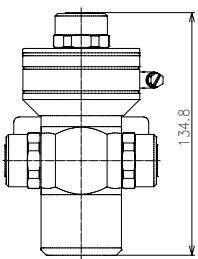

## Symmetric Splitters



330 - 2700 MHz

Part Number	BN 818292	BN 818293	BN 818294
Version (outputs)	2	3	4
Frequency range	330 - 2700 MHz		
Insertion loss	≤ 3.2 dB	≤ 5.0 dB	≤ 6.5 dB
Passive intermodulation (IM3) @ 2 x 20 W	≤ -160 dBc		
VSWR	≤ 1.2		
Power rating	≤ 450 W		
Connectors	4.3 - 10 female		
Temperature range	-40 °C ... +75 °C		
Degree of protection (mated)	IP68		
Weight	~ 1.1 kg	~ 1.1 kg	~ 1.2 kg
Mounting brackets	Included		



BN 818292



BN 818293



BN 818294

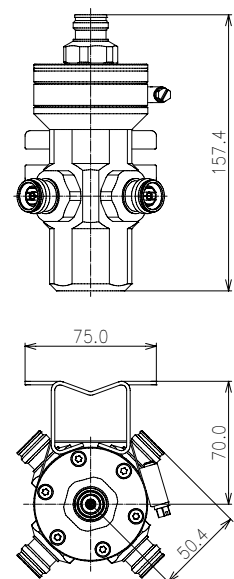
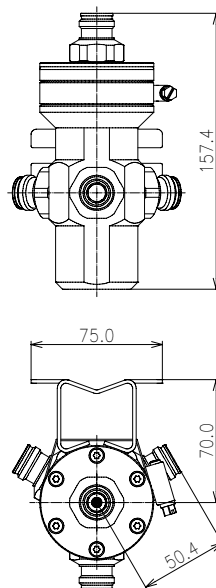
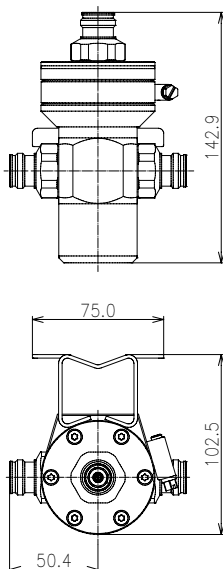

## Symmetric Splitters

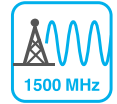
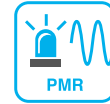

330 - 2700 MHz

Part Number	BN 923089	BN 923090	BN 923091
Version (outputs)	2	3	4
Frequency range	330 - 2700 MHz		
Insertion loss	≤ 3.2 dB	≤ 5.0 dB	≤ 6.5 dB
Passive intermodulation (IM3) @ 2 x 20 W	≤ -160 dBc		
VSWR	≤ 1.2		
Power rating	≤ 250 W		
Connectors	N female		
Temperature range	-40 °C ... +75 °C		
Degree of protection (mated)	IP68		
Weight	~ 1.1 kg	~ 1.1 kg	~ 1.2 kg
Mounting brackets	Included		



BN 923089

BN 923090

BN 923091

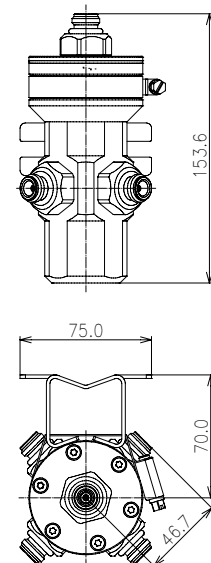
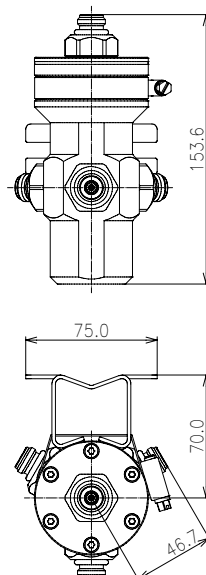
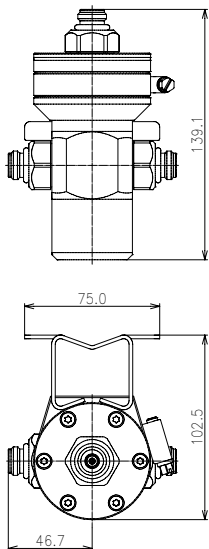

## Symmetric Splitters

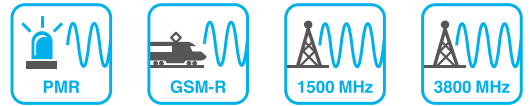

350 - 3800 MHz

Part Number	BN 818269	BN 818273	BN 818274
Version (outputs)	2	3	4
Frequency range	350 - 3800 MHz		
Insertion loss	≤ 3.3 dB	≤ 5.2 dB	≤ 6.6 dB
Passive intermodulation (IM3) @ 2 x 20 W	≤ -155 dBc; typ. ≤ -160 dBc		
VSWR	≤ 1.25		≤ 1.35
Power rating	≤ 300 W		
Connectors	4.3-10 female		
Temperature range	-30 °C ... +65 °C		
Degree of protection (mated)	IP 65		
Weight	~ 1.0 kg	~ 1.0 kg	~ 1.1 kg
Mounting brackets	BN B30342		



BN 818269

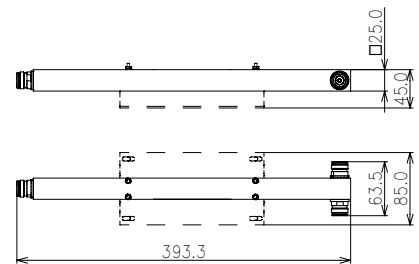

BN 818273

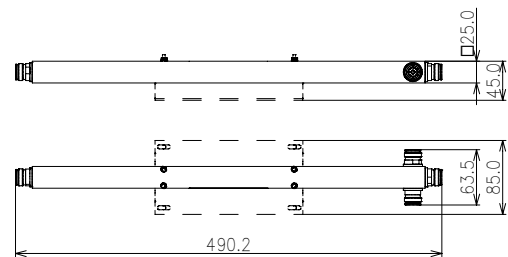

BN 818274

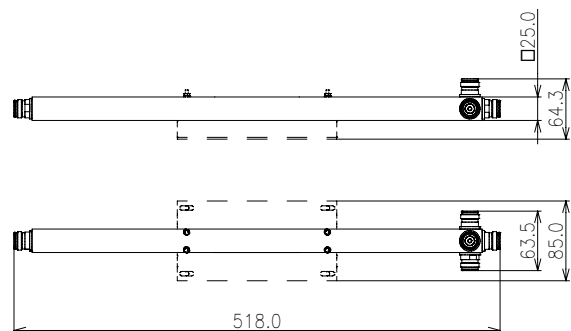

## Symmetric Splitters

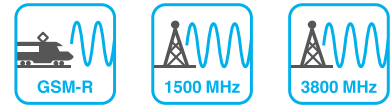

694 - 3800 MHz

Part Number	BN 433003	BN 433004	BN 433005
Version (outputs)	2	3	4
Frequency range	694 - 3800 MHz		
Insertion loss	≤ 3.1 dB	≤ 4.8 dB	≤ 6.2 dB
Passive intermodulation (IM3) @ 2 x 20 W	≤ -155 dBc; typ. ≤ -160 dBc		
VSWR	≤ 1.3 @ 694 - 2700 MHz ≤ 1.4 @ 2700 - 3800 MHz		
Power rating	≤ 300 W		
Connectors	4.3-10 female		
Temperature range	-25 °C ... +55 °C		
Degree of protection (mated)	IP 65		
Weight	~ 0.4 kg	~ 0.5 kg	~ 0.7 kg
Mounting brackets	<b>BN B26441</b>	<b>BN B26443</b>	<b>BN B26444</b>



**BN 433003**

**BN 433004**

**BN 433005**

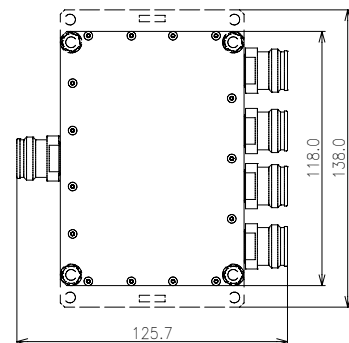
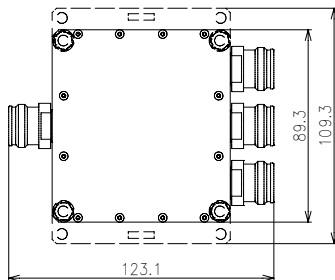
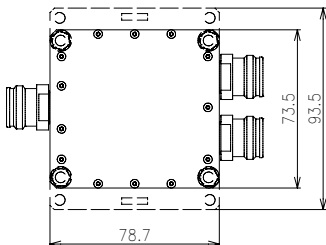
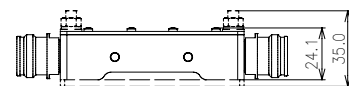
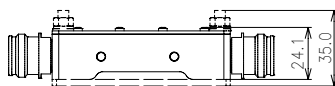
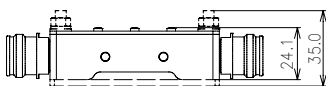

## Symmetric Splitters



694 - 2700 MHz

Part Number	BN 433000	BN 433001	BN 433002	BN 923067	BN 923068	BN 923069
Version (outputs)	2	3	4	2	3	4
Frequency range	694 - 2700 MHz					
Insertion loss	≤ 3.1 dB	≤ 4.8 dB	≤ 6.1 dB	≤ 3.1 dB	≤ 4.8 dB	≤ 6.1 dB
Passive intermodulation (IM3) @ 2 x 20 W	≤ -160 dBc; typ. ≤ -165 dBc					
VSWR	≤ 1.3					
Power rating	≤ 300 W					
Connectors	4.3-10 female			N female		
Temperature range	-25 °C ... +55 °C					
Degree of protection (mated)	IP 62					
Weight	~ 0.3 kg	~ 0.4 kg	~ 0.5 kg	~ 0.2 kg	~ 0.3 kg	~ 0.4 kg
Mounting brackets	BN B23655	BN B23656	BN B23657	BN B23655	BN B23656	BN B23657



BN 433000

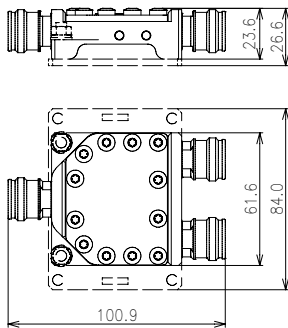

BN 433001

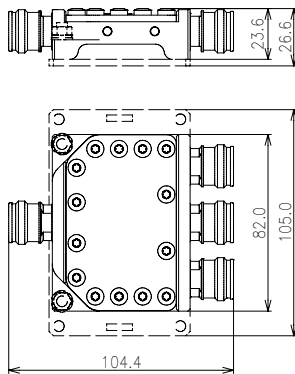

BN 433002

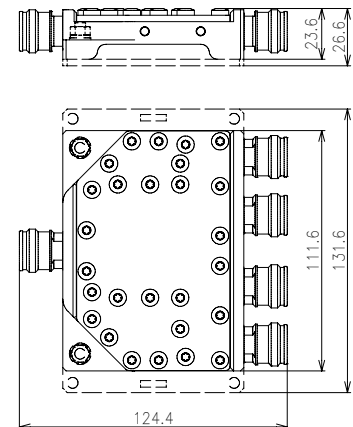

## Symmetric Splitters

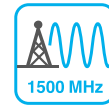

694 - 3800 MHz

Part Number	BN 818263	BN 818264	BN 818265
Version (outputs)	2	3	4
Frequency range	694 - 3800 MHz		
Insertion loss	≤ 3.2 dB	≤ 5.0 dB	≤ 6.2 dB
Passive intermodulation (IM3) @ 2 x 20 W	≤ -160 dBc; typ. ≤ -165 dBc		
VSWR	≤ 1.2		
Power rating	≤ 500 W		
Connectors	7-16 female		
Temperature range	-40 °C ... +85 °C		
Degree of protection (mated)	IP 68		
Weight	~ 0.4 kg	~ 0.5 kg	~ 0.6 kg
Mounting brackets	BN B07691		BN B15701



BN 818263



BN 818264



BN 818265

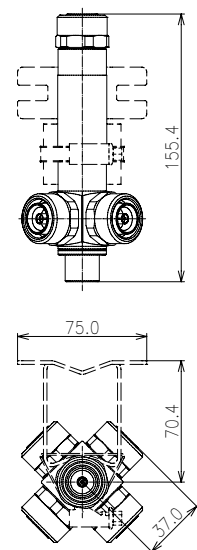
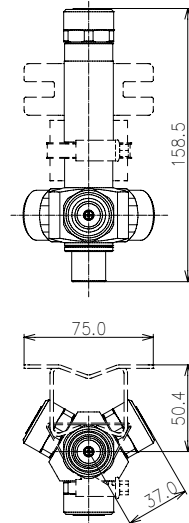
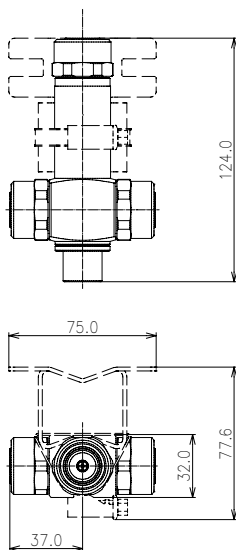



## Symmetric Splitters

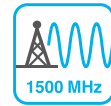

694 - 3800 MHz

Part Number	BN 818266	BN 818267	BN 818268
Version (outputs)	2	3	4
Frequency range	694 - 3800 MHz		
Insertion loss	≤ 3.2 dB	≤ 5.0 dB	≤ 6.2 dB
Passive intermodulation (IM3) @ 2 x 20 W	≤ -160 dBc; typ. ≤ -165 dBc		
VSWR	≤ 1.2		
Power rating	≤ 500 W		
Connectors	4.3-10 female		
Temperature range	-40 °C ... +85 °C		
Degree of protection (mated)	IP 68		
Weight	~ 0.4 kg	~ 0.5 kg	~ 0.6 kg
Mounting brackets	BN B07691		BN B15701



BN 818266



BN 818267



BN 818268

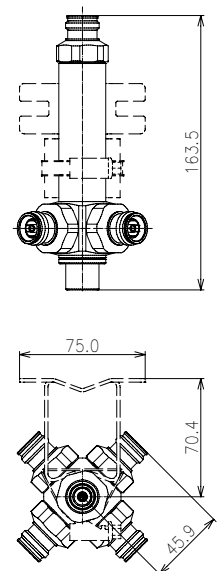
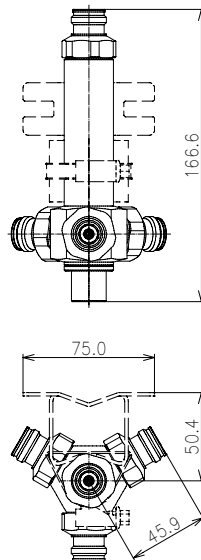
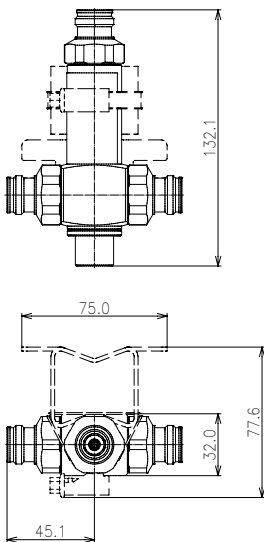

## Symmetric Splitters

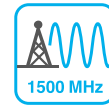

694 - 3800 MHz

Part Number	BN 923063	BN 923064	BN 923065
Version (outputs)	2	3	4
Frequency range	694 - 3800 MHz		
Insertion loss	≤ 3.2 dB	≤ 5.0 dB	≤ 6.2 dB
Passive intermodulation (IM3) @ 2 x 20 W	≤ -160 dBc; typ. ≤ -165 dBc		
VSWR	≤ 1.2		
Power rating	≤ 250 W		
Connectors	N female		
Temperature range	-40 °C ... +85 °C		
Degree of protection (mated)	IP 68		
Weight	~ 0.4 kg	~ 0.5 kg	~ 0.6 kg
Mounting brackets	BN B07691		BN B15701



BN 923063



BN 923064



BN 923065

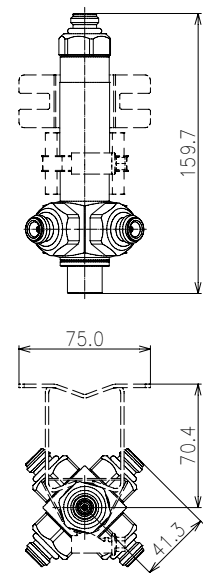
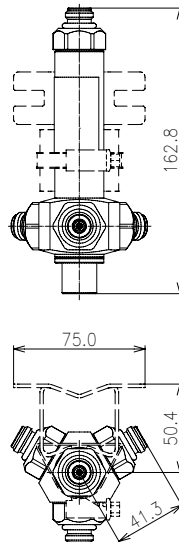
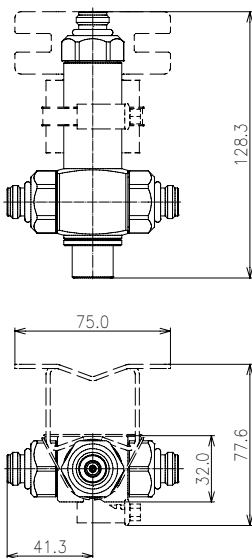

## Symmetric Splitters



870 - 960 MHz

<b>Part Number</b>	<b>BN 818257</b>
Version (outputs)	2
Frequency range	870 - 960 MHz
Insertion loss	≤ 3.2 dB
Passive intermodulation (IM3) @ 2 x 20 W	≤ -150 dBc; typ. ≤ -160 dBc
VSWR	≤ 1.1
Power rating	≤ 800 W
Connectors	7-16 male / 7-16 female
Temperature range	-40 °C ... +55 °C
Degree of protection (mated)	IP 65
Weight	~ 0.6 kg
Mounting brackets	Included



**BN 818257**

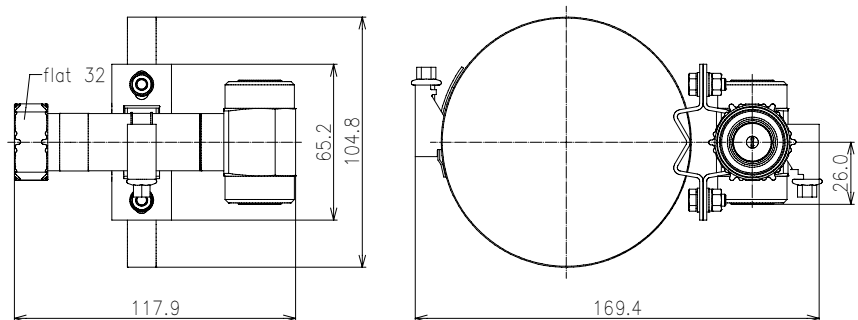

## Asymmetric Splitters

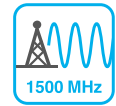
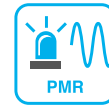

170 - 2700 MHz

Part Number	BN 818242	BN 818243	BN 818244	BN 818245	BN 818246	BN 818299	BN 818248	BN 818249
Version (splitting ratio) Secondary line Main line	1/4 3/4	1/5 4/5	1/6 5/6	1/10 9/10	1/20 19/20	1/30 29/30	1/100 99/100	1/1000 999/1000
Frequency range	170 – 1500 MHz 1710 – 2700 MHz							
Insertion loss Secondary line	6.0 dB	7.0 dB	8.0 dB	10.0 dB	13.0 dB	15.0 dB	20.0 dB	30.0 dB
Passive intermodulation (IM3) @ 2 x 20 W	≤ -155 dBc; typ. ≤ -160 dBc							
VSWR	≤ 1.45	≤ 1.35		≤ 1.2				
Power rating	≤ 500 W							
Connectors	7-16 female							
Temperature range	-40 °C ... +70 °C							
Degree of protection (mated)	IP 68							
Weight	~ 0.6 kg							
Mounting brackets	BN B09499							



BN 818242 / BN 818243 / BN 818244

BN 818245 / BN 818246 / BN 818248 /  
BN 818249 / BN 818299

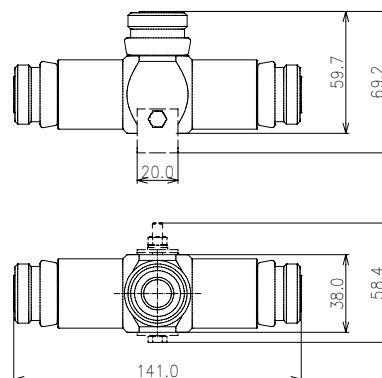
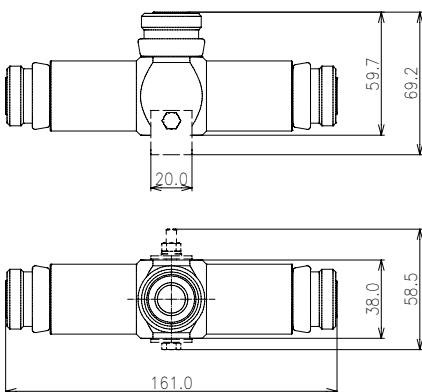

## Asymmetric Splitters

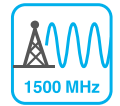

170 - 2700 MHz

Part Number	BN 818342	BN 818343	BN 818344	BN 818345	BN 818346	BN 818399	BN 818348	BN 818349
Version (splitting ratio) Secondary line Main line	1/4 3/4	1/5 4/5	1/6 5/6	1/10 9/10	1/20 19/20	1/30 29/30	1/100 99/100	1/1000 999/1000
Frequency range	170 – 1500 MHz 1710 – 2700 MHz							
Insertion loss Secondary line	6.0 dB	7.0 dB	8.0 dB	10.0 dB	13.0 dB	15.0 dB	20.0 dB	30.0 dB
Passive intermodulation (IM3) @ 2 x 20 W	≤ -160 dBc; typ. ≤ -165 dBc							
VSWR	≤ 1.45	≤ 1.35					≤ 1.2	
Power rating	≤ 500 W							
Connectors	4.3-10 female							
Temperature range	-40 °C ... +70 °C							
Degree of protection (mated)	IP 68							
Weight	~ 0.6 kg							
Mounting brackets	BN B09499							



BN 818342 / BN 818343 / BN 818344



BN 818345 / BN 818346 / BN 818348 /  
BN 818349 / BN 818399

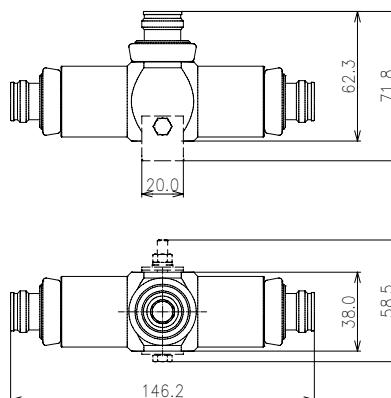
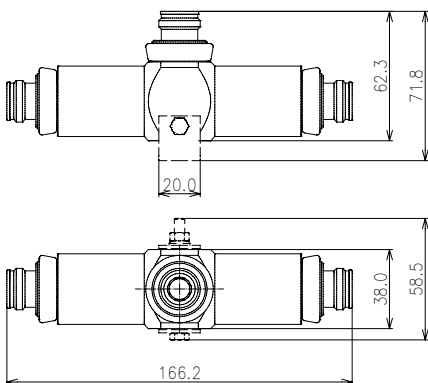

## Asymmetric Splitters

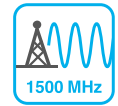

170 - 2700 MHz

Part Number	BN 923042	BN 923043	BN 923044	BN 923045	BN 923046	BN 923099	BN 923048	BN 923049
Version (splitting ratio) Secondary line Main line	1/4 3/4	1/5 4/5	1/6 5/6	1/10 9/10	1/20 19/20	1/30 29/30	1/100 99/100	1/1000 999/1000
Frequency range	170 – 1500 MHz 1710 – 2700 MHz							
Insertion loss Secondary line	6.0 dB	7.0 dB	8.0 dB	10.0 dB	13.0 dB	15.0 dB	20.0 dB	30.0 dB
Passive intermodulation (IM3) @ 2 x 20 W	≤ -150 dBc; typ. ≤ -155 dBc							
VSWR	≤ 1.45	≤ 1.35					≤ 1.2	
Power rating	≤ 250 W							
Connectors	N female							
Temperature range	-40 °C ... +70 °C							
Degree of protection (mated)	IP 68							
Weight	~ 0.6 kg							
Mounting brackets	BN B09499							



BN 923042 / BN 923043 / BN 923044



BN 923045 / BN 923046 / BN 923048 /  
BN 923049 / BN 923099

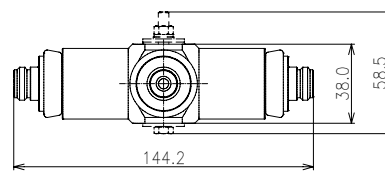
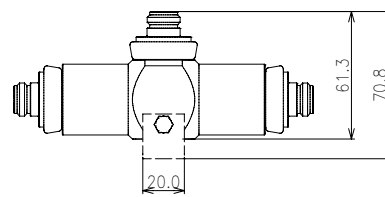
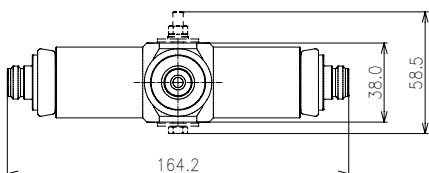
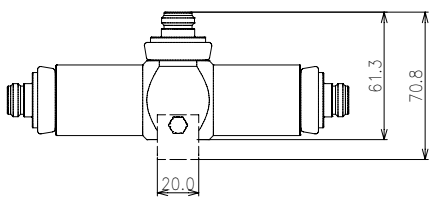

## Asymmetric Splitters

380 - 3800 MHz

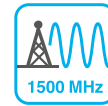
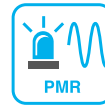

Part Number	BN 818458	BN 818459	BN 818460	BN 818461	BN 818462	BN 818463	BN 818464	BN 818465
Version (splitting ratio)								
Secondary line	1/3	1/4	1/5	1/6	1/10	1/20	1/30	1/100
Main line	2/3	3/4	4/5	5/6	9/10	19/20	29/30	99/100
Frequency range	380 – 3800 MHz							
Insertion loss								
Secondary line	4.8 dB	6 dB	7 dB	8 dB	10 dB	13 dB	15 dB	20 dB
Passive intermodulation (IM3) @ 2 x 20 W	≤ -155 dBc; typ. ≤ -160 dBc							
VSWR	≤ 1.3							
Power rating	≤ 300 W							
Connectors	4.3 -10 female							
Temperature range	-40 °C ... +55 °C							
Degree of protection (mated)	IP 65							
Weight	~ 300 g							
Mounting brackets	BN B23656							



BN 818459

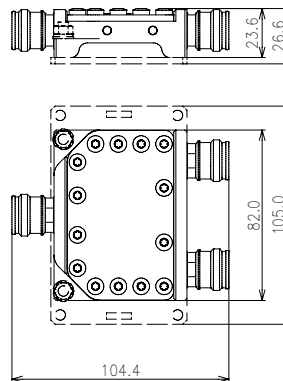

## Asymmetric Splitters

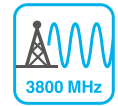
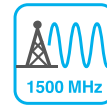
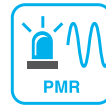

350 - 3800 MHz

Part Number	BN 818440	BN 818441	BN 818442	BN 818443	BN 818444	BN 818445	BN 818446	BN 818447	BN 818448
Version (splitting ratio) Secondary line Main line	1/3 2/3	1/4 3/4	1/5 4/5	1/6 5/6	1/10 9/10	1/20 19/20	1/30 29/30	1/100 99/100	1/1000 999/1000
Frequency range	350 – 3800 MHz								
Insertion loss Secondary line	4.8 dB	6 dB	7 dB	8 dB	10 dB	13 dB	15 dB	20 dB	30 dB
Isolation	≥ 23 dB	≥ 24 dB	≥ 25 dB	≥ 26 dB	≥ 28 dB	≥ 30 dB	≥ 32 dB	≥ 35 dB	≥ 45 dB
Passive intermodulation (IM3) @ 2 x 20 W	≤ -155 dBc; typ. ≤ -160 dBc								
VSWR	≤ 1.3								
Power rating	≤ 500 W								
Connectors	7-16 female								
Temperature range	-35 °C ... +75 °C								
Degree of protection (mated)	IP 65								
Weight	~ 880 g								
Mounting brackets	Included								



BN 818443

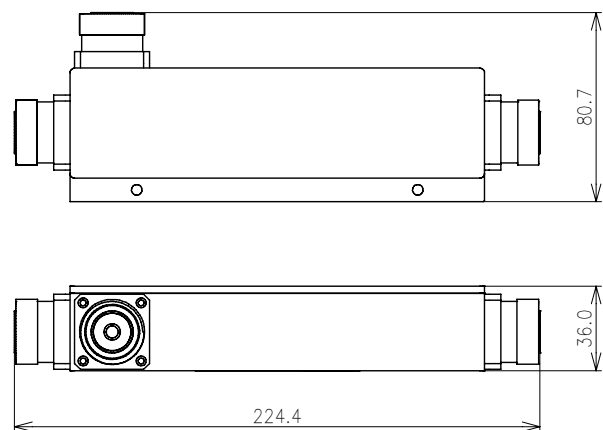



## Asymmetric Splitters

350 - 3800 MHz



Part Number	BN 818431	BN 818432	BN 818433	BN 818434	BN 818435	BN 818436	BN 818437	BN 818438	BN 818439
Version (splitting ratio)									
Secondary line	1/3	1/4	1/5	1/6	1/10	1/20	1/30	1/100	1/1000
Main line	2/3	3/4	4/5	5/6	9/10	19/20	29/30	99/100	999/1000
Frequency range	350 – 3800 MHz								
Insertion loss									
Secondary line	4.8 dB	6 dB	7 dB	8 dB	10 dB	13 dB	15 dB	20 dB	30 dB
Isolation	≥ 23 dB	≥ 24 dB	≥ 25 dB	≥ 26 dB	≥ 28 dB	≥ 30 dB	≥ 32 dB	≥ 35 dB	≥ 45 dB
Passive intermodulation (IM3) @ 2 x 20 W	≤ -155 dBc; typ. ≤ -160 dBc								
VSWR	≤ 1.3								
Power rating	≤ 400 W								
Connectors	4.3 -10 female								
Temperature range	-35 °C ... +75 °C								
Degree of protection (mated)	IP 65								
Weight	~ 680 g								
Mounting brackets	Included								



BN 818431

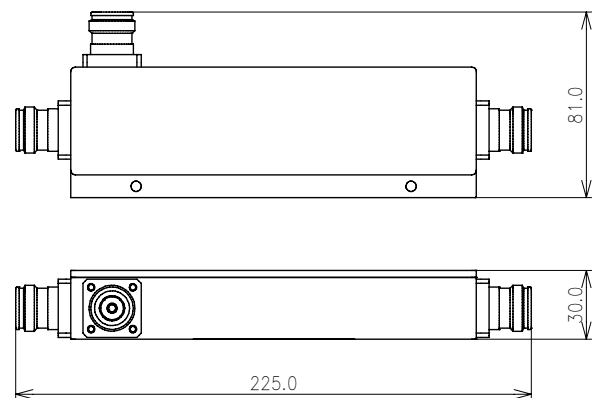

## Asymmetric Splitters

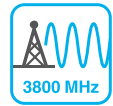
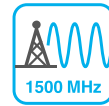

690 - 3800 MHz

Part Number	BN 818449	BN 818450	BN 818451	BN 818452	BN 818453	BN 818454	BN 818455	BN 818456	BN 818457
Version (splitting ratio) Secondary line Main line	1/3 2/3	1/4 3/4	1/5 4/5	1/6 5/6	11/100 89/100	1/10 9/10	1/20 19/20	1/30 29/30	1/100 99/100
Frequency range	690 – 2170 MHz 2300 – 3800 MHz								
Insertion loss Secondary line	4.8 dB	6 dB	7 dB	8 dB	9 dB	10 dB	13 dB	15 dB	20 dB
Passive intermodulation (IM3) @ 2 x 20 W	≤ -153 dBc								
VSWR	≤ 1.3								
Power rating	≤ 300 W								
Connectors	4.3-10 female								
Temperature range	-30 °C ... +75 °C								
Degree of protection (mated)	IP 65								
Weight	~ 220 g								
Mounting brackets	BN B30578								



BN 818449

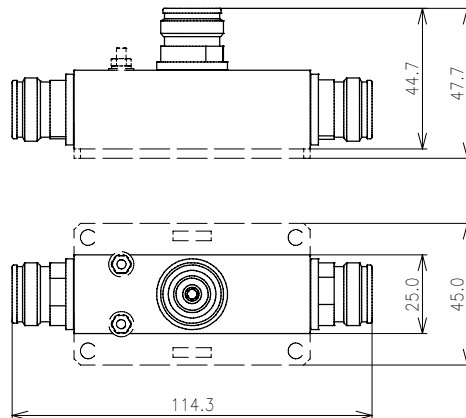

## Asymmetric Splitters



694 - 2700 MHz

Part Number	BN 818355	BN 818356	BN 818357	BN 818362	BN 818358	BN 818366	BN 818359	BN 818360	BN 818361
Version (splitting ratio) Secondary line Main line	1/3 2/3	1/4 3/4	1/5 4/5	1/6 5/6	1/10 9/10	1/20 19/20	1/30 29/30	1/100 99/100	1/1000 999/1000
Frequency range	694 - 2700 MHz								
Insertion loss Secondary line	4.8 dB	6 dB	7 dB	8 dB	10 dB	13 dB	15 dB	20 dB	30 dB
Isolation	≥ 25 dB	≥ 26 dB	≥ 27 dB	≥ 28 dB	≥ 30 dB	≥ 33 dB	≥ 35 dB	≥ 40 dB	≥ 45 dB
Passive intermodulation (IM3) @ 2 x 20 W	≤ -155 dBc; typ. ≤ -160 dBc								
VSWR	≤ 1.25								
Power rating	≤ 300 W								
Connectors	7-16 female								
Temperature range	-40 °C ... +80 °C								
Degree of protection (mated)	IP 65								
Weight	~ 660 g								
Mounting brackets	BN B26399								



BN 818355

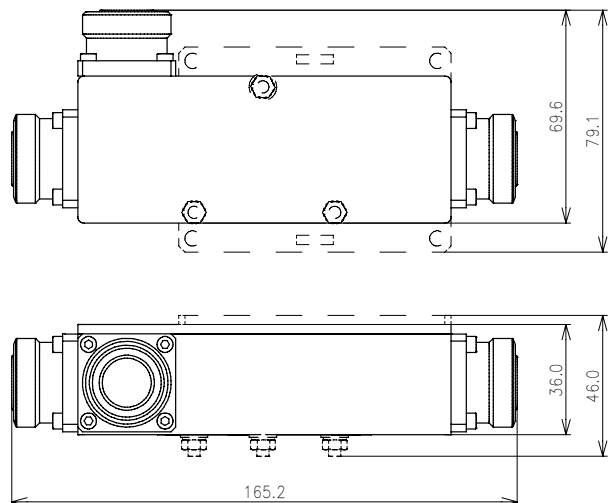

## Asymmetric Splitters

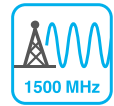

694 - 2700 MHz

Part Number	BN 923014	BN 923001	BN 923003	BN 923006	BN 923007	BN 923008	BN 923009	BN 923012	BN 923013
Version (splitting ratio) Secondary line Main line	1/3 2/3	1/4 3/4	1/5 4/5	1/6 5/6	1/10 9/10	1/20 19/20	1/30 29/30	1/100 99/100	1/1000 999/1000
Frequency range	694 - 2700 MHz								
Insertion loss Secondary line	4.8 dB	6 dB	7 dB	8 dB	10 dB	13 dB	15 dB	20 dB	30 dB
Isolation	≥ 25 dB	≥ 26 dB	≥ 27 dB	≥ 28 dB	≥ 30 dB	≥ 33 dB	≥ 35 dB	≥ 40 dB	≥ 45 dB
Passive intermodulation (IM3) @ 2 x 20 W	≤ -155 dBc; typ. ≤ -160 dBc								
VSWR	≤ 1.25								
Power rating	≤ 300 W								
Connectors	4.3-10 female								
Temperature range	-40 °C ... +80 °C								
Degree of protection (mated)	IP 65								
Weight	~ 550 g								
Mounting brackets	BN B26399								



BN 923014

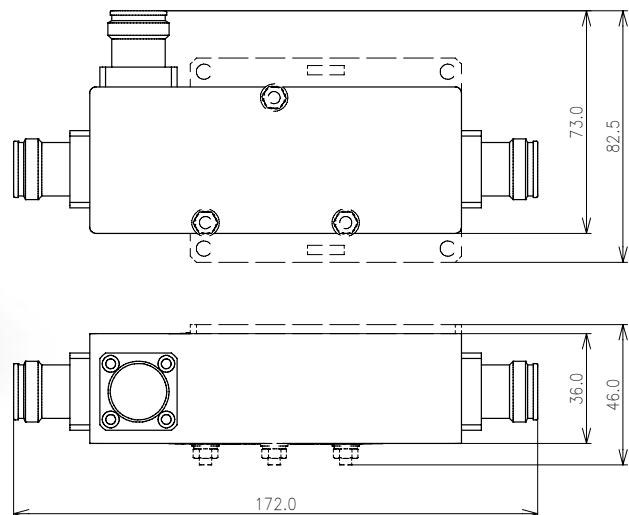

## Asymmetric Splitters



694 - 2700 MHz

Part Number	BN 923071	BN 923056	BN 923057	BN 923062	BN 923058	BN 923066	BN 923059	BN 923060	BN 923061
Version (splitting ratio) Secondary line Main line	1/3 2/3	1/4 3/4	1/5 4/5	1/6 5/6	1/10 9/10	1/20 19/20	1/30 29/30	1/100 99/100	1/1000 999/1000
Frequency range	694 - 2700 MHz								
Insertion loss Secondary line	4.8 dB	6 dB	7 dB	8 dB	10 dB	13 dB	15 dB	20 dB	30 dB
Isolation	≥ 25 dB	≥ 26 dB	≥ 27 dB	≥ 28 dB	≥ 30 dB	≥ 33 dB	≥ 35 dB	≥ 40 dB	≥ 45 dB
Passive intermodulation (IM3) @ 2 x 20 W	≤ -155 dBc; typ. ≤ -160 dBc								
VSWR	≤ 1.25								
Power rating	≤ 300 W								
Connectors	N female								
Temperature range	-40 °C ... +80 °C								
Degree of protection (mated)	IP 65								
Weight	~ 350 g								
Mounting brackets	BN B23654								



BN 923058

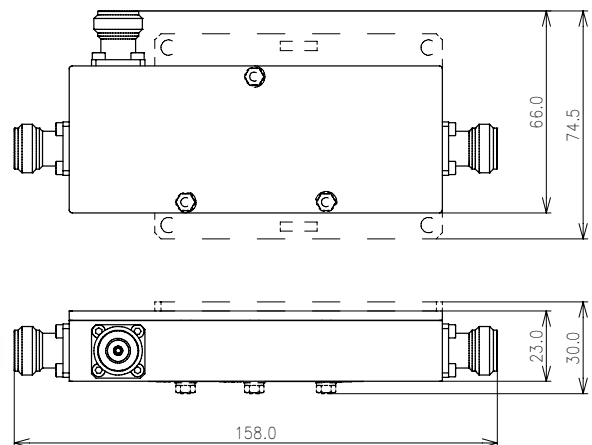

## Directional Couplers



330 - 520 MHz

Part Number	BN 753381	BN 753382	BN 753383	BN 753386
Version	H-style			
Frequency range	330 - 520 MHz			
Coupling attenuation	3.0 dB	6.0 dB	10.0 dB	20.0 dB
Isolation	≥ 36 dB	≥ 36 dB	≥ 40 dB	≥ 50 dB
VSWR	≤ 1.06			
Power rating	≤ 1000 W			
Connectors	7-16 female			
Temperature range	-40 °C ... +70 °C			
Degree of protection (mated)	IP 68			
Weight	~ 1.4 kg			
Mounting brackets	<b>BN B13702</b>			



**BN 753381 / BN 753382 / BN 753383**

**BN 753386**

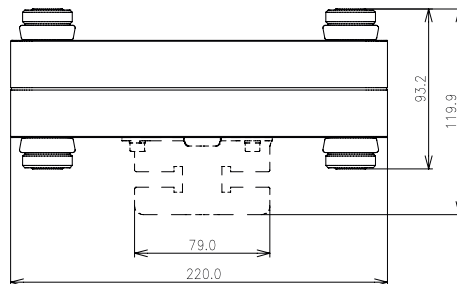
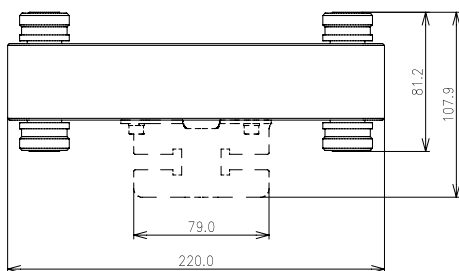
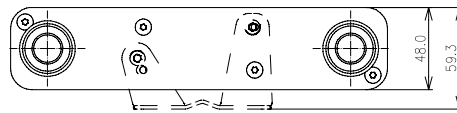

## Directional Couplers



350 - 2700 MHz

Part Number	BN 753357	BN 753359	BN 753358
Version	X-style		
Frequency range	350 - 2700 MHz		
Coupling attenuation	3.0 dB		
Isolation	≥ 23 dB; typ. ≥ 25 dB		
Passive intermodulation (IM3) @ 2 x 20 W	≤ -155 dBc		
VSWR	≤ 1.25		
Power rating	≤ 300 W		
Connectors	7-16 female	4.3-10 female	N female
Temperature range	-40 °C ... +80°C		
Degree of protection (mated)	IP 65		
Weight	~ 0.9 kg	~ 0.8 kg	~ 0.7 kg
Mounting brackets	Included		



BN 753359

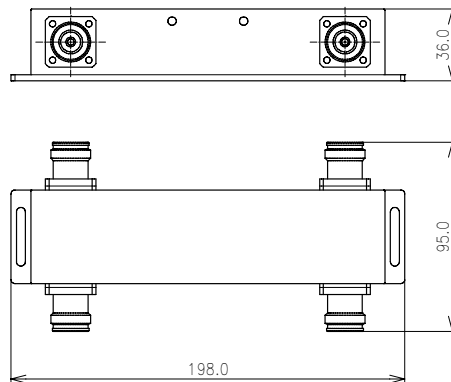

## Directional Couplers

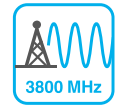
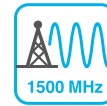

694 - 3800 MHz

Part Number	BN 753368	BN 753369	BN 923083
Version	X-style		
Frequency range	694 - 3800 MHz		
Coupling attenuation	3.0 dB		
Isolation	≥ 30 dB; typ. ≥ 35 dB		≥ 25 dB
Passive intermodulation (IM3) @ 2 x 20 W	≤ -160 dBc		≤ -155 dBc
VSWR	≤ 1.08 @ 694 - 2700 MHz ≤ 1.10 @ 2700 - 3800 MHz		≤ 1.25
Power rating	≤ 500 W @ 694 - 2000 MHz ≤ 300 W @ 2000 - 3800 MHz		≤ 300 W
Connectors	7-16 female	4.3-10 female	
Temperature range	-40 °C ... +70°C		-40 °C ... +65°C
Degree of protection (mated)	IP 68		IP 65
Weight	~ 1.8 kg		~ 0.8 kg
Mounting brackets	BN B13702		Included



BN 753369

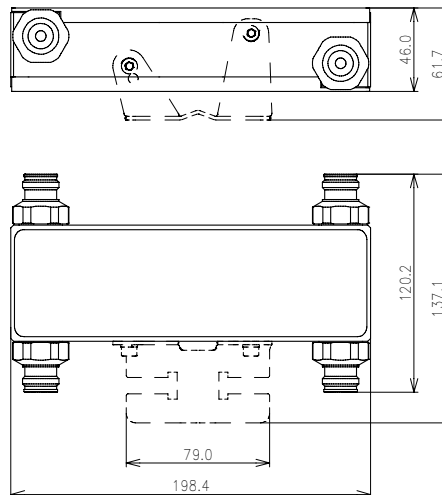



## Directional Couplers



694 - 2700 MHz

Part Number	BN 753355	BN 753360	BN 753352	BN 753356	BN 753348	BN 753349	BN 753353	
Version	X-style	H-style						
Frequency range	694- 2700 MHz							
Coupling attenuation	3.0 dB	3.0 dB	3.0 dB	4.8 dB	6.0 dB	10.0 dB	30.0 dB	
Isolation	694 - 2200 MHz 2200 - 2500 MHz 2500 - 2700 MHz	≥ 33 dB ≥ 31 dB ≥ 28 dB	≥ 33 dB ≥ 33 dB ≥ 28 dB	≥ 33 dB ≥ 33 dB ≥ 28 dB	≥ 35 dB ≥ 30 dB ≥ 27 dB	≥ 36 dB ≥ 30 dB ≥ 27 dB	≥ 39 dB ≥ 34 dB ≥ 31 dB	≥ 60 dB ≥ 60 dB ≥ 60 dB
Passive intermodulation (IM3) @ 2 x 20 W	≤ -160 dBc; typ. ≤ -165 dBc	≤ -155 dBc; typ. ≤ -160 dBc	≤ -160 dBc; typ. ≤ -165 dBc					
VSWR	694 - 2200 MHz 2200 - 2500 MHz 2500 - 2700 MHz	≤ 1.06 ≤ 1.08 ≤ 1.10	≤ 1.06 ≤ 1.06 ≤ 1.10	≤ 1.06 ≤ 1.06 ≤ 1.10	≤ 1.08 ≤ 1.12 ≤ 1.14	≤ 1.08 ≤ 1.15 ≤ 1.15	≤ 1.10 ≤ 1.20 ≤ 1.30	≤ 1.06 ≤ 1.06 ≤ 1.06
Power rating	≤ 1000 W	≤ 500 W	≤ 1000 W					
Connectors	7-16 female	N female	7-16 female					
Temperature range	-40 °C ... +70 °C							
Degree of protection (mated)	IP 68							
Weight	~ 0.9 kg	~ 1.2 kg						
Mounting brackets	BN B13702							



BN 753355



BN 753360



BN 753352 / BN 753356 / BN 753348 /  
BN 753349 / BN 753353

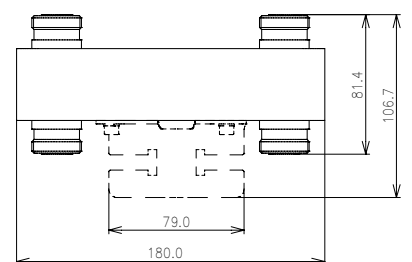
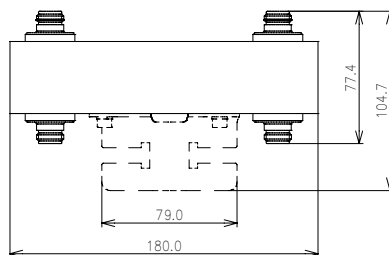
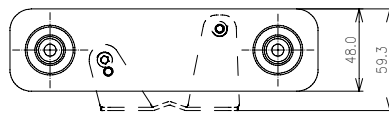
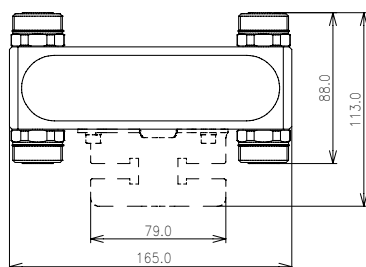
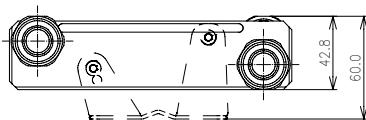

## Directional Couplers

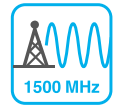

694 - 2700 MHz

Part Number	BN 753366	BN 753361	BN 753362	BN 753363	BN 753364	BN 753365	
Version	X-style		H-style				
Frequency range	694 - 2700 MHz						
Coupling attenuation	3.0 dB	3.0 dB	4.8 dB	6.0 dB	10.0 dB	30.0 dB	
Isolation	694 - 2200 MHz 2200 - 2500 MHz 2500 - 2700 MHz	≥ 33 dB ≥ 31 dB ≥ 28 dB	≥ 33 dB ≥ 33 dB ≥ 28 dB	≥ 35 dB ≥ 30 dB ≥ 27 dB	≥ 36 dB ≥ 30 dB ≥ 27 dB	≥ 39 dB ≥ 34 dB ≥ 31 dB	≥ 60 dB ≥ 60 dB ≥ 60 dB
Passive intermodulation (IM3) @ 2 x 20 W	≤ -160 dBc; typ. ≤ -165 dBc						
VSWR	694 - 2200 MHz 2200 - 2500 MHz 2500 - 2700 MHz	≤ 1.06 ≤ 1.08 ≤ 1.10	≤ 1.06 ≤ 1.06 ≤ 1.10	≤ 1.08 ≤ 1.12 ≤ 1.14	≤ 1.08 ≤ 1.15 ≤ 1.15	≤ 1.10 ≤ 1.20 ≤ 1.30	≤ 1.06 ≤ 1.06 ≤ 1.06
Power rating	≤ 500 W						
Connectors	4.3-10 female						
Temperature range	-40 °C ... +70 °C						
Degree of protection (mated)	IP 68						
Weight	~ 0.9 kg		~ 1.2 kg				
Mounting brackets	BN B13702						



BN 753366



BN 753361 / BN 753362 / BN 753363 /  
BN 753364 / BN 753365

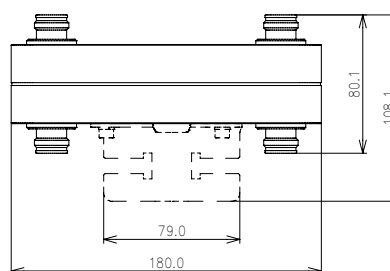
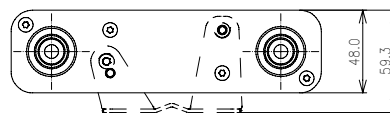
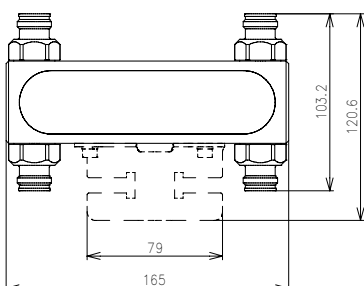

## Directional Couplers



694 - 2700 MHz

Part Number	BN 753391	BN 753390
Version	H-style unidirectional	
Frequency range	694 - 2700 MHz	
Coupling attenuation	3.0 dB	6.0 dB
Isolation	≥ 33 dB @ 694 - 2200 MHz ≥ 33 dB @ 2200 - 2500 MHz ≥ 28 dB @ 2500 - 2700 MHz	≥ 36 dB @ 694 - 2200 MHz ≥ 30 dB @ 2200 - 2500 MHz ≥ 27 dB @ 2500 - 2700 MHz
Passive intermodulation (IM3) @ 2 x 20 W	≤ -160 dBc; typ. ≤ -165 dBc	
VSWR	≤ 1.06 @ 694 - 2500 MHz ≤ 1.10 @ 2500 - 2700 MHz	≤ 1.08; typ. ≤ 1.06 @ 694 - 2200 MHz ≤ 1.15; typ. ≤ 1.10 @ 2200 - 2700 MHz
Power rating	≤ 500 W	
Connectors	4.3-10 female	
Temperature range	-40 °C ... +70°C	
Degree of protection (mated)	IP 68	
Weight	~ 1.2 kg	
Mounting brackets	BN B13702	

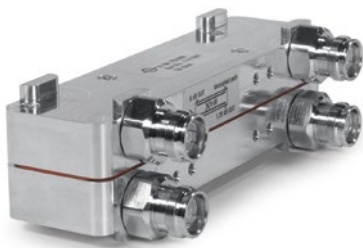

BN 753390

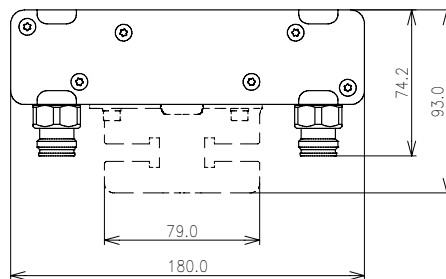
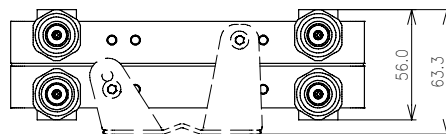

## Directional Couplers

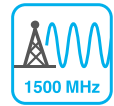

694 - 2700 MHz

Part Number	BN 923075	BN 923076	BN 923070
Version	X-style		
Frequency range	694 - 2700 MHz		
Coupling attenuation	3.0 dB		
Isolation	≥ 25 dB		
Passive intermodulation (IM3) @ 2 x 20 W	≤ -155 dBc; typ. ≤ -160 dBc		
VSWR	≤ 1.25		
Power rating	≤ 300 W		
Connectors	7-16 female	4.3-10 female	N female
Temperature range	-40 °C ... +80°C		
Degree of protection (mated)	IP 65		
Weight	~ 0.9 kg	~ 0.8 kg	~ 0.8 kg
Mounting brackets	BN B23742		



BN 923070

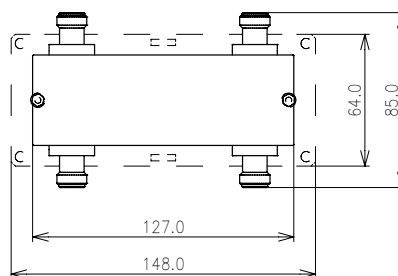
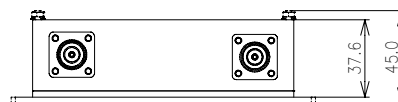



## Antennas

For indoor coverage, SPINNER offers three different types of antennas:



**Panel antennas  
for wall mount**



**Omni antennas  
for ceiling mount**



**Omni chip antennas  
for ceiling mount**

The table below maps antenna types to frequencies. All antennas are shown on the next pages.

Frequency Range in MHz														
	380 - 470	694 - 788	791 - 862	876 - 960	1427 - 1518	1710 - 1880	1850 - 1990	1920 - 2170	2300 - 2400	2400 - 2500	2496 - 2690	3300 - 3800	4900 - 6000	
Examples														
	TETRA PMR	LTE700	LTE800	LTE900 GSM900 GSM-R	LTE1500 L-Band	GSM1800 LTE1800 AWS RX	PCS1900	UMTS AWS TX	LTE2300	WLAN	LTE2500 LTE2600	5G	5G WLAN	
Type														Page
A77137 SISO Omni-Chip-H	380 - 520		694 - 960					1690 - 2700						169
A77144 SISO Omni-V	380 - 520		694 - 960					1690 - 6000						168
A77149 SISO Panel-V	380 - 520		698 - 960					1710 - 2700				3400 - 4000		167
A77146 SISO Card-Omni-H			617 - 960		1350 - 1550			1690 - 2700				3300 - 3800	4900 - 6000	169
A77147 MIMO Chip-Omni-HH			694 - 960		1350 - 1550			1710 - 2700				3300 - 4000		169
A77140 SISO Panel-V			694 - 960					1350 - 2700				3400 - 4000		167
A77143 SISO Omni-H			694 - 960					1350 - 2700				3400 - 4000		169
A77141 SISO Omni-V			694 - 960					1427 - 2700						168
A77148 MIMO Omni-Chip-VH			694 - 960					1427 - 2700				3400 - 3800		169
A77145 SISO Omni-V			694 - 960			1427 - 2180				2305 - 6000				168
A77139 MIMO Panel-X			694 - 960					1690 - 2700				3300 - 4000		167
A77138 MIMO Panel-VH			694 - 960					1690 - 2700				3400 - 4000		167
A77136 MIMO Panel-X			698 - 960					1710 - 2700						167
A77142 MIMO Omni-VH			698 - 960					1710 - 2700				3400 - 4000		169

## Antennas

### Panel Antennas for Wall Mount

Part Number	BN A77149	BN A77140	BN A77139	BN A77138	BN A77136
Polarization	Vertical	Vertical	±45°	Dual	±45°
Beamwidth	70°	75°	70°	75°	70°
Frequency range	380 - 4000 MHz	694 - 4000 MHz		698 - 2700 MHz	
Ports	1	1	2		
Gain	≥ 4.0 dBi ... ≥ 7.5 dBi	≥ 5.0 dBi ... ≥ 8.5 dBi	≥ 6.0 dBi ... ≥ 7.5 dBi	≥ 5.0 dBi ... ≥ 8.5 dBi	≥ 6.4 dBi ... ≥ 8.1 dBi
Passive intermodulation (IM3) @ 2 x 20 W	≤ -140 dBc	≤ -153 dBc			≤ -150 dBc
VSWR	≤ 2.5 @ 380 - 520 MHz ≤ 2.0 @ 698 - 6000 MHz	≤ 2.0	≤ 1.8	≤ 2.0	≤ 1.5
Power rating	50 W				
Connector(s)	4.3-10 female				
Temperature range	-55 °C ... +60 °C				
Material and color	ABS, white, RAL9003				
Degree of protection	IP 54				
Weight	~ 0.6 kg	~ 0.4 kg	~ 1.0 kg	~ 1.5 kg	~ 0.9 kg
Mounting material	Included				



BN A77140



BN A77139

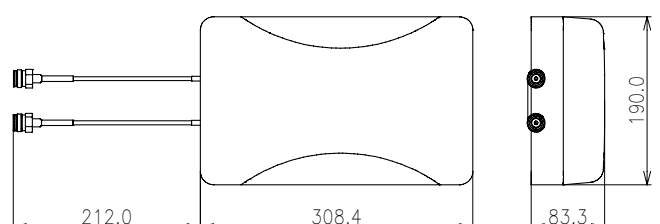
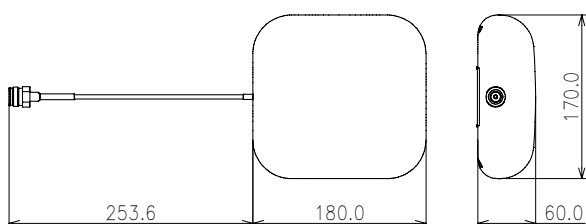

## Antennas

### Omni Antennas for Ceiling Mount

Part Number	BN A77144	BN A77145	BN A77141
Polarization	Vertical		
Beamwidth	360°		
Frequency range	380 - 6000 MHz	694 - 6000 MHz	694 - 2700 MHz
Ports	1		
Gain	≥ 2.0 dBi ... ≥ 4.0 dBi	≥ 2.0 dBi ... ≥ 4.5 dBi	≥ 1.8 dBi ... ≥ 3.0 dBi
Passive intermodulation (IM3) @ 2 x 20 W	≤ -153 dBc		
VSWR	≤ 3.0 @ 380 - 520 MHz ≤ 2.0 @ 694 - 6000 MHz	≤ 1.8 @ 694 - 806 MHz ≤ 1.5 @ 860 - 2700 MHz ≤ 1.8 @ 2700 - 6000 MHz	≤ 1.8 @ 694 - 806 MHz ≤ 1.5 @ 806 - 960 MHz ≤ 1.8 @ 1427 - 1710 MHz ≤ 1.5 @ 1710 - 2700 MHz
Power rating	50 W		
Connector(s)	4.3-10 female		
Temperature range	-55 °C ... +60 °C		
Material and color	ABS, white, RAL9003		
Degree of protection	IP 54		
Weight	~ 0.9 kg	~ 0.5 kg	~ 0.4 kg
Mounting material	Included		

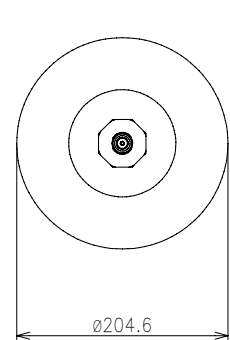
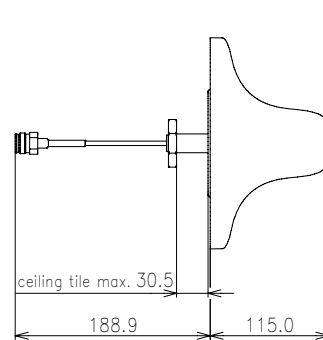
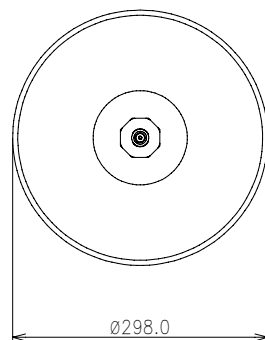
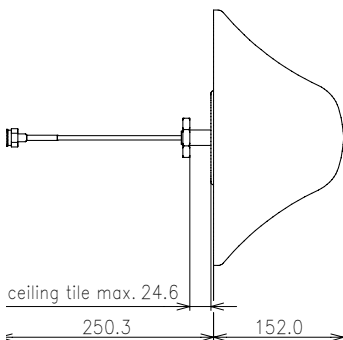



## Antennas

### Omni Chip Antennas for Ceiling Mount

Part Number	BN A77137	BN A77146	BN A77148	BN A77147	BN A77143	BN A77142
Polarization	Horizontal		Dual	Dual Horizontal	Horizontal	Dual
Beamwidth	360°					
Frequency range	380 - 2700 MHz	617 - 6000 MHz	694 - 3800 MHz	694 - 4000 MHz		698 - 4000 MHz
Ports	1		2		1	2
Gain	≥ 2.0 dBi ... ≥ 4.5 dBi	≥ 1.5 dBi ... ≥ 6.0 dBi	≥ 2.5 dBi ... ≥ 5.0 dBi	≥ 1.5 dBi ... ≥ 6.0 dBi	≥ 2.2 dBi ... ≥ 6.0 dBi	≥ 3.0 dBi ... ≥ 5.0 dBi
Passive intermodulation (IM3) @ 2 x 20 W	≤ -140 dBc *)	≤ -153 dBc				≤ -150 dBc
VSWR	≤ 2.5 @ 380 - 520 MHz ≤ 2.0 @ 694 - 2700 MHz	≤ 1.8		≤ 1.8 ≤ 2.0 @ 1350 - 1550 MHz	≤ 1.5 ≤ 1.8 @ 1350 - 1710 MHz	≤ 2.0
Power rating	50 W					
Connector(s)	4.3-10 female					
Temperature range	-55 °C ... +60 °C					
Material and color	ABS, white, RAL9003					
Degree of protection	IP 54					
Weight	~ 0.4 kg	~ 0.3 kg	~ 0.4 kg	~ 0.5 kg	~ 0.3 kg	~ 0.5 kg
Mounting material	Included					

\*) Variant with IM3 ≤ -150 dBc is available, please order BN 77137C0001



**BN A77137**

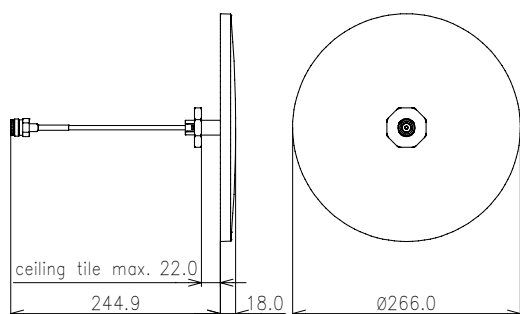

**BN A77148**

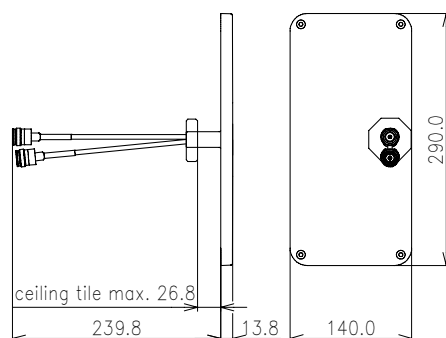

## Absorbing Products

SPINNER loads and attenuators are often used in the installation and calibration of mobile radio communication stations, but also in measurement technology applications in which they excel thanks to their excellent IM properties.



Low PIM loads

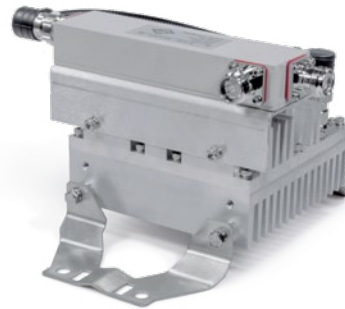

Low PIM attenuators



Loads



Attenuators

### Loads and Attenuators – Now Even More Flexible

Both for the loads and for the attenuators, SPINNER has developed a new modular system by means of which you are significantly more flexible in choosing your components. The requirements for performance and the connector system are diverse and the new system enables you to easily combine loads and attenuators with the performance and connector system specified by you. Thus, you are able to combine your components freely to meet your requirements and do not have to use oversized components or adapters without the support of which you could not even install the components. The advantages are obvious: cost savings and improved technical values.

The new modular system is available for the 25 W, 50 W, 100 W and 200 W performance versions as well as for 7-16, 4.3-10 and N connector system. Of course, you will be able to choose from connectors and couplers of the connector systems mentioned above. The standard version is available between 0 and 4 GHz. Extended versions are possible up to 6 GHz. Moreover, you can order your versions with an integrated DC block as well as with a measurement report.



Standard Loads



Standard Attenuators

## Loads

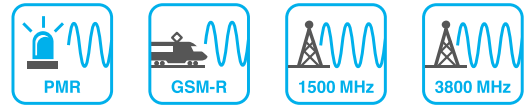

### Low Intermodulation Loads

Part Number	BN 534279	BN 534280	BN 534277
Frequency range	350 – 3800 MHz		
Passive intermodulation (IM3) @ 2 x 20 W	≤ -140 dBc; typ. ≤ -145dBc @ 350 - 694 MHz ≤ -150 dBc; typ. ≤ -155dBc @ 694 - 870 MHz ≤ -160 dBc; typ. ≤ -165dBc @ 870 - 3000 MHz		
VSWR	≤ 1.15; typ. ≤ 1.08 @ 350 - 3000 MHz ≤ 1.20; typ. ≤ 1.15 @ 3000 - 3800 MHz		
Power dissipation	≤ 50 W	≤ 100 W	≤ 150 W
Connectors	7-16 female		
Temperature range	-40° C ... +50° C		
Degree of protection (mated)	IP 20		
Weight	~ 2.0 kg	~ 2.8 kg	~ 4.1 kg
Mounting brackets	BN B20962 or BN B20963 (see data sheet)		



BN 534279



BN 534280



BN 534277

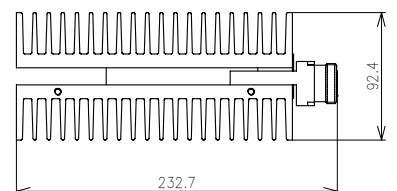
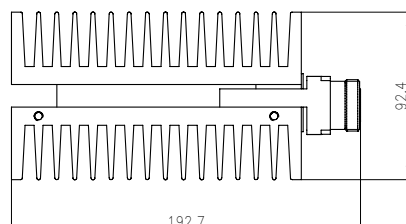
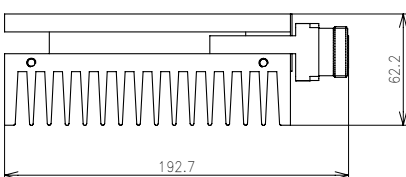
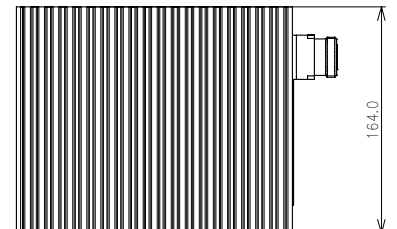
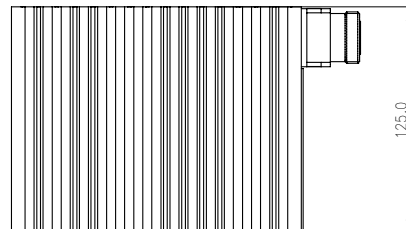
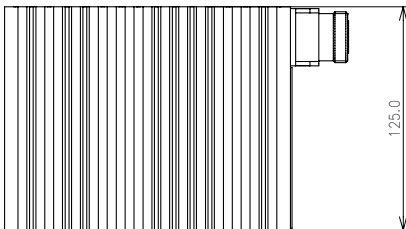

## Loads

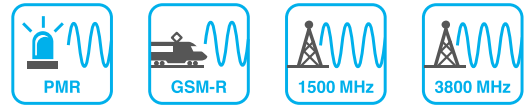

### Low Intermodulation Loads

<b>Part Number</b>	<b>BN 534276</b>
Frequency range	380 –4000 MHz
Passive intermodulation (IM3) @ 2 x 20 W	≤ -160 dBc @ 380 - 2700 MHz
VSWR	≤ 1.25 @ 380 – 694 MHz ≤ 1.15 @ 694 – 4000 MHz
Power dissipation	≤ 250 W @ 380 - 694 MHz ≤ 400 W @ 694 - 2700 MHz ≤ 250 W @ 2700 - 4000 MHz
Connectors	7-16 female
Temperature range	-5° C ... +55° C
Degree of protection (mated)	IP 20
Weight	~ 14.5 kg
Mounting brackets	<b>BN B20641</b>



**BN 534276**

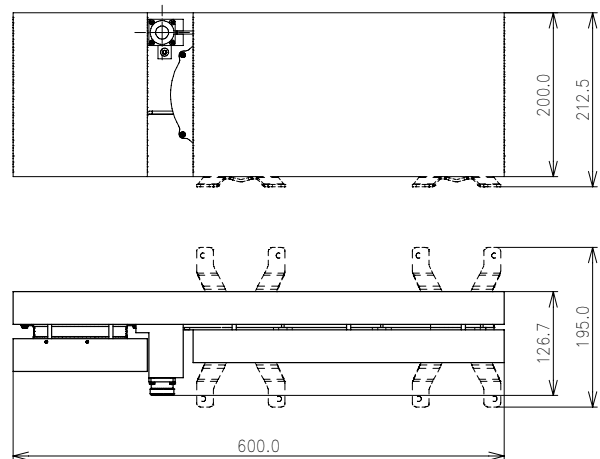

## Loads

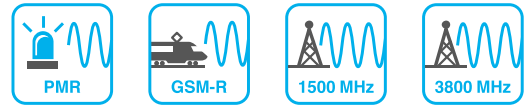

### Low Intermodulation Loads

Part Number	BN 594272	BN 594273	BN 594274	BN 594275
Frequency range	350 – 3800 MHz			
Passive intermodulation (IM3) @ 2 x 20 W	≤ -140 dBc; typ. ≤ -145dBc @ 350 - 694 MHz ≤ -150 dBc; typ. ≤ -155dBc @ 694 - 800 MHz ≤ -160 dBc; typ. ≤ -165dBc @ 800 - 3000 MHz			
VSWR	≤ 1.15; typ. ≤ 1.08 @ 350 – 3000 MHz ≤ 1.20; typ. ≤ 1.15 @ 3000 – 3800 MHz			
Power dissipation	≤ 20 W	≤ 50 W	≤ 100 W	≤ 150 W
Connectors	7-16 female			
Temperature range	-40° C ... +50° C			
Degree of protection (mated)	IP 68			
Weight	~ 1.2 kg	~ 2.5 kg	~ 3.5 kg	~ 5.3 kg
Mounting brackets	BN B20962 or BN B20963 (see data sheet)			



BN 594272

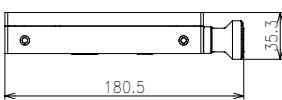
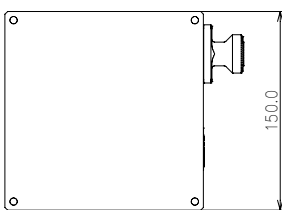

BN 594273

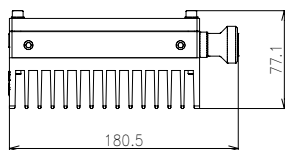
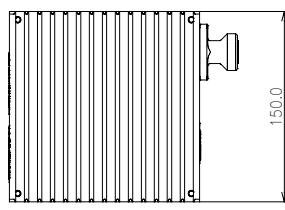

BN 594274

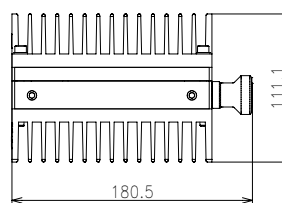
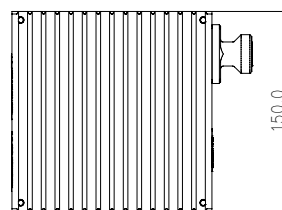

BN 594275

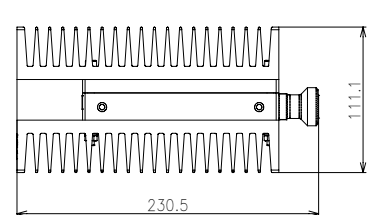
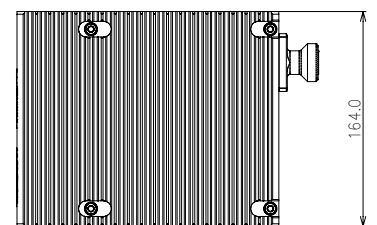

## Loads

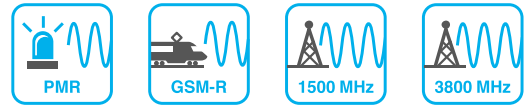

### Low Intermodulation Loads

Part Number	BN 594276	BN 594278
Frequency range	350 – 3800 MHz	
Passive intermodulation (IM3) @ 2 x 20 W	≤ -160 dBc; typ. ≤ -165dBc @ 350 - 3000 MHz	
VSWR	≤ 1.20; typ ≤ 1.15 @ 350 – 694 MHz ≤ 1.15; typ ≤ 1.10 @ 694 – 3800 MHz	
Power dissipation	≤ 200 W	
Connectors	7-16 female	4.3-10 female
Temperature range	-40° C ... +40° C	
Degree of protection (mated)	IP 68	
Weight	~ 8.2 kg	
Mounting brackets	BN B20962	



BN 594278

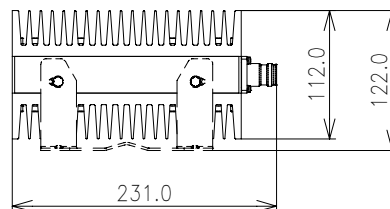
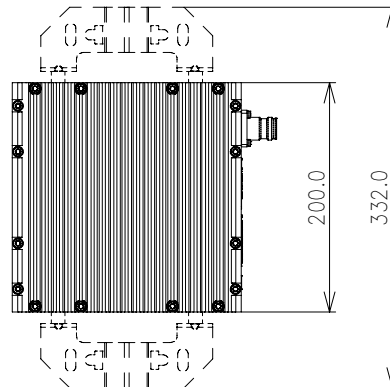

## Loads

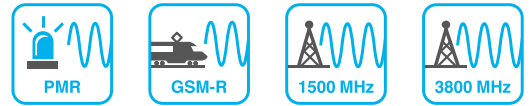

### Low Intermodulation Loads

Part Number	BN 594282	BN 594283	BN 594284	BN 594285
Frequency range	350 – 3800 MHz			
Passive intermodulation (IM3) @ 2 x 20 W	≤ - 140 dBc; typ. ≤ -145dBc @ 350 - 694 MHz ≤ - 150 dBc; typ. ≤ -155dBc @ 694 - 800 MHz ≤ - 160 dBc; typ. ≤ -165dBc @ 800 - 3000 MHz			
VSWR	≤ 1.15; typ ≤ 1.08 @ 350 – 3000 MHz ≤ 1.20; typ ≤ 1.15 @ 3000 – 3800 MHz			
Power dissipation	≤ 20 W	≤ 50 W	≤ 100 W	≤ 150 W
Connectors	4.3-10 female			
Temperature range	-40° C ... +50° C			
Degree of protection (mated)	IP 68			
Weight	~ 1.2 kg	~ 2.5 kg	~ 3.5 kg	~ 5.3 kg
Mounting brackets	BN B20962 or BN B20963			



BN 594282



BN 594283



BN 594284



BN 594285

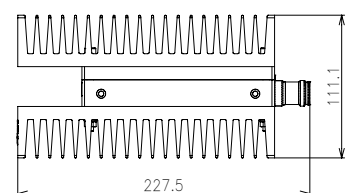
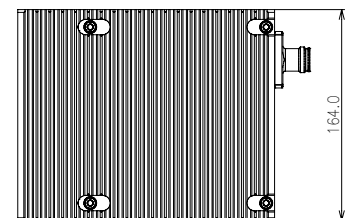
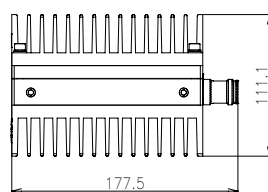
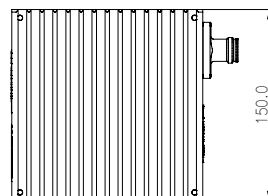
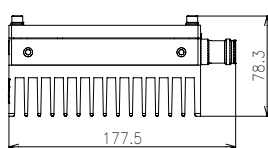
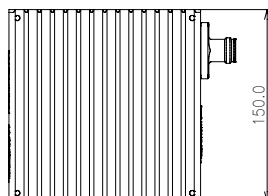
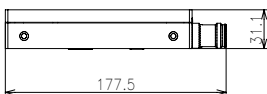
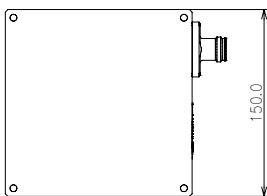

## Loads



### Low Intermodulation Loads

<b>Part Number</b>	<b>BN 534268</b>
Frequency range	350 – 3800 MHz
Passive intermodulation (IM3) @ 2 x 20 W	$\leq -140$ dBc; typ. $\leq -145$ dBc @ 350 - 694 MHz $\leq -150$ dBc; typ. $\leq -155$ dBc @ 694 - 800 MHz $\leq -160$ dBc; typ. $\leq -165$ dBc @ 800 - 3000 MHz
VSWR	$\leq 1.15$ @ 350 – 3000 MHz $\leq 1.20$ @ 3000 – 3800 MHz
Power dissipation	$\leq 450$ W ( $\leq 150$ W per port)
Connectors	7-16 female
Temperature range	$-40^{\circ}$ C ... $+30^{\circ}$ C
Degree of protection (mated)	IP 68
Weight	~ 18 kg
Mounting brackets	Included



**BN 534268**

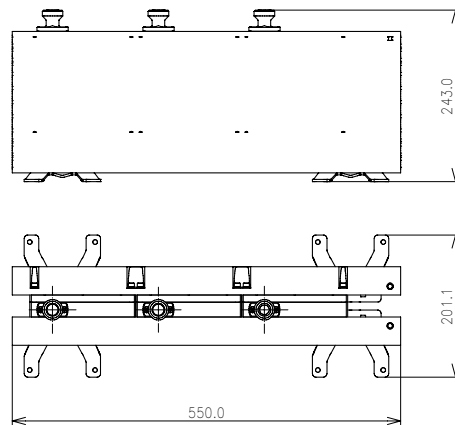



## Loads

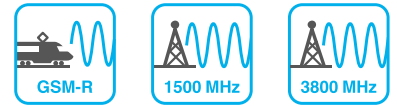

### Low Intermodulation Loads

<b>Part Number</b>	<b>BN 534267</b>
Frequency range	694 – 3800 MHz
Passive intermodulation (IM3) @ 2 x 20 W	≤ -155 dBc; typ. ≤ -160 dBc @ 694 - 800 MHz ≤ -160 dBc; typ. ≤ -165 dBc @ 800 - 3000 MHz
VSWR	≤ 1.15 @ 694 – 2700 MHz ≤ 1.25 @ 2700 – 3800 MHz
Power dissipation	≤ 400 W
Connectors	7-16 female
Temperature range	-40° C ... +30° C
Degree of protection (mated)	IP 67
Weight	~ 19 kg
Mounting brackets	Included



BN 534267

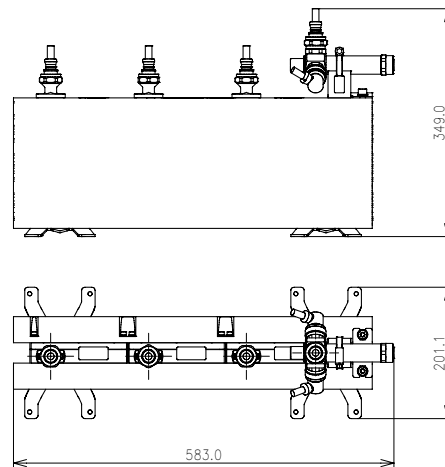

## Loads

### Standard Loads - Modular Construction System for 25 to 200 W Loads

The standard loads are foreseen for individual configuration. Four power levels from 25 W to 200 W are available. The connectors can be chosen from 7-16, 4.3-10 and N, either male or female. 4.3-10 male versions are available with screw, hand screw and push-pull version.

As special features, the loads can be ordered with an extended frequency range up to 6 GHz and with measurement protocol included in the delivery. The individual configuration can be chosen by the article code shown on page 179.

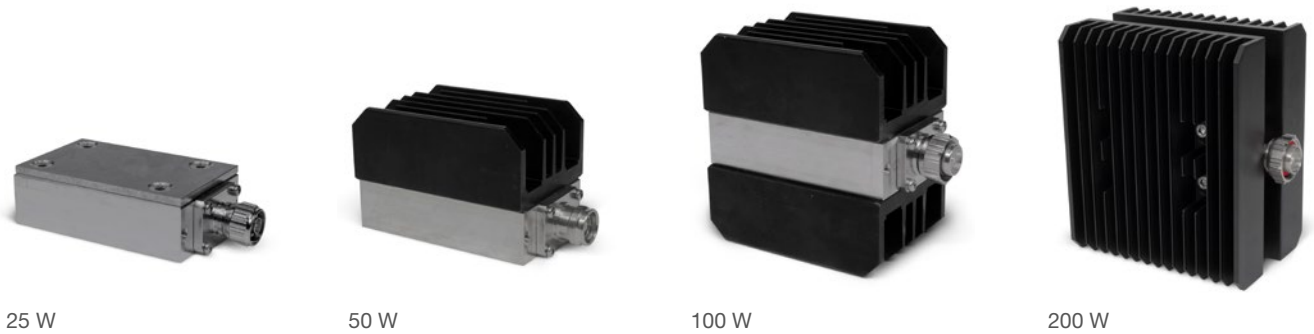

Power dissipation	25 W	50 W	100 W	200 W
Frequency range	0 - 4000 MHz (special feature up to 6000 MHz)			
VSWR	≤ 1.06 @ 0 - 1000 MHz ≤ 1.14 @ 1000 - 2000 MHz ≤ 1.20 @ 2000 - 3000 MHz ≤ 1.30 @ 3000 - 4000 MHz (≤ 1.40 @ 4000 - 6000 MHz)			
Temperature range	-40 °C ... +40 °C			
Degree of protection (mated)	IP 50			
Weight	~ 0.6 kg	~ 0.9 kg	~ 1.1 kg	~ 2.7 kg



## Loads

### Standard Loads - Article Codes

Please use article codes for inquiries and orders.

These are self explaining and enable you to specify a product without knowing its part number.

Load	Power Dissipation		Connector	Extra Feature
<b>L</b>	<b>X</b>	<b>-</b>	<b>Z</b>	<b>-X</b>
25 W	25			Leave blank if N/A
50 W	50			
100 W	100			
200 W	200			
7-16 male			7M	
7-16 female			7F	
4.3-10 male; screw			43MS	
4.3-10 male; hand screw			43MH	
4.3-10 male; push-pull			43MP	
4.3-10 female			43F	
N male			NM	
N female			NF	
Measurement protocol				P
Extended frequency range				E
Upgrade from IP 50 to IP 68 (outdoor capable)				O
Extended frequency range + measurement protocol				EP
Measurement protocol + IP 68				PO
Extended frequency range + IP 68				EO
Extended frequency range + measurement protocol + IP 68				EPO

### Example of article codes:

**L50-7M:** Load with 50 W power dissipation and 7-16 male connector.

**L200-43MP-P:** Load with 200 W power dissipation and 4.3-10 male push-pull connector.  
Ships with extended frequency range from DC to 6 GHz.

## Loads

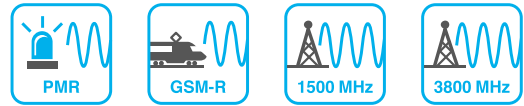

### Loads

Part Number	BN 531702	BN 531712	BN 531726	BN 531727	BN 531225	BN 531227	BN 531221
Frequency range	0 - 4000 MHz		0 - 7000 MHz				
VSWR	≤ 1.06 @ 0 - 1000 MHz ≤ 1.11 @ 1000 - 2000 MHz ≤ 1.17 @ 2000 - 5000 MHz ≤ 1.22 @ 5000 - 7000 MHz						
Power dissipation	≤ 2 W	≤ 5 W			≤ 10 W		
Connectors	4.3-10 male screw type	7-16 male	4.3-10 male screw type	N male	7-16 male	4.3-10 male screw type	N male
Temperatur range	-40 °C ... +40 °C						
Degree of protection (mated)	IP 68	IP 64	IP 68	IP 64		IP 68	IP 64
Weight	~ 55 g	~ 100 g	~ 55 g	~ 40 g	~ 120 g	~ 85 g	~ 80 g



BN 531702



BN 531727



BN 531225

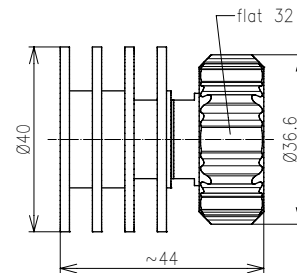
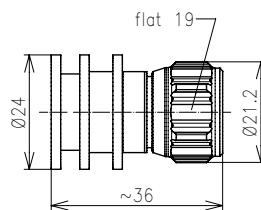
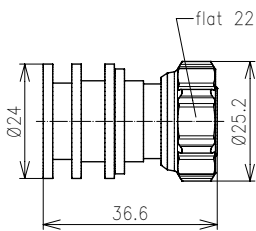

## Loads



### Loads

Part Number	BN 547720	BN 527757	BN 527755	BN 527751
Frequency range	0 – 4000 MHz	0 - 7000 MHz		
VSWR	≤ 1.07 @ 0 – 1000 MHz ≤ 1.10 @ 1000 – 2000 MHz ≤ 1.15 @ 2000 – 3000 MHz ≤ 1.20 @ 3000 – 4000 MHz	≤ 1.06 @ 0 – 1000 MHz ≤ 1.11 @ 1000 – 2000 MHz ≤ 1.17 @ 2000 – 5000 MHz ≤ 1.22 @ 5000 – 7000 MHz		
Power dissipation	≤ 25 W			
Connectors	7-16 male		4.3-10 male	N male
Temperature range	-40 °C ... +40 °C			
Degree of protection (mated)	IP 65	IP 40	IP 68	IP 40
Weight	~ 240 g	~ 200 g	~ 130 g	~ 120 g



BN 547720



BN 527755



BN 527751

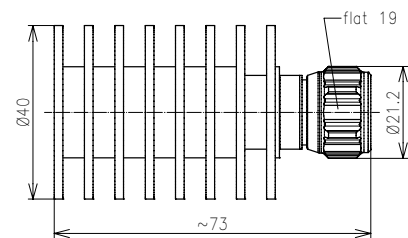
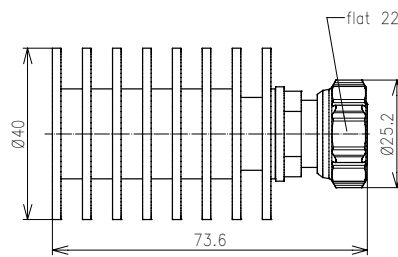
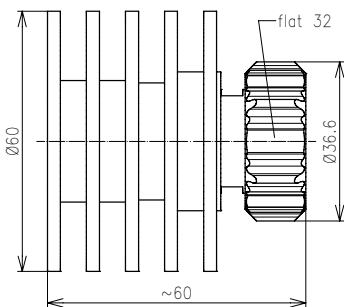

## Loads

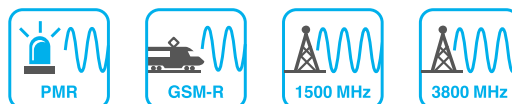

### Loads

Part Number	<b>BN 547700</b>
Frequency range	0 – 4000 MHz
VSWR	$\leq 1.07 @ 0 - 1000 \text{ MHz}$ $\leq 1.10 @ 1000 - 2000 \text{ MHz}$ $\leq 1.15 @ 2000 - 3000 \text{ MHz}$ $\leq 1.20 @ 3000 - 4000 \text{ MHz}$
Power dissipation	$\leq 50 \text{ W}$
Connectors	7-16 male
Temperature range	-40 °C ... +40 °C
Degree of protection (mated)	IP 65
Weight	~ 380 g



**BN 547700**

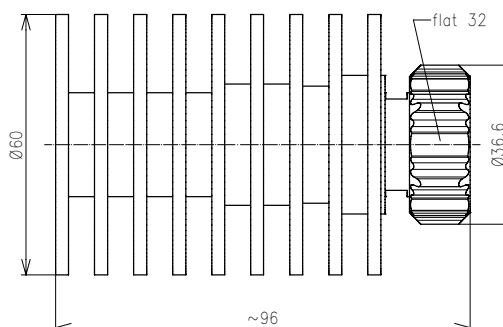

## Attenuators

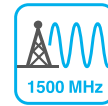
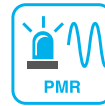

### Low Intermodulation Attenuators

Part Number	BN 745401	BN 745402	BN 745403	BN 745404	BN 745405	BN 745406	BN 745407	BN 745408	BN 745409
Frequency range	350 - 3800 MHz								
Attenuation	4.8 dB	6.0 dB	7.0 dB	8.0 dB	10 dB	13 dB	15 dB	20 dB	30 dB
Passive intermodulation (IM3) @ 2 x 20 W	≤ -140 dBc; typ. ≤ -145 dBc @ 350 - 694 MHz ≤ -150 dBc; typ. ≤ -155 dBc @ 694 - 800 MHz ≤ -155 dBc; typ. ≤ -160 dBc @ 800 - 3000 MHz								
VSWR	≤ 1.3								
Power rating	≤ 80 W								
Connectors	4.3-10 female								
Temperature range	-40 °C ... +50 °C								
Degree of protection (mated)	IP 65								
Weight	~ 3.0 kg								
Mounting brackets	<b>BN B07787</b>								

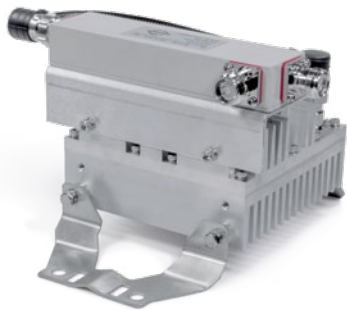

BN 745401

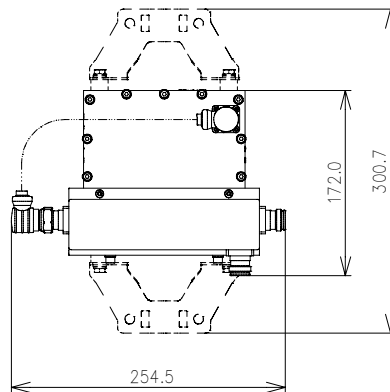
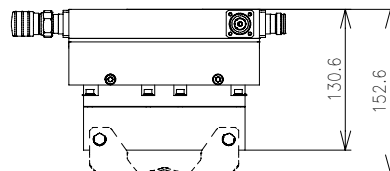

## Attenuators

### Standard Attenuators - Modular Construction System for 25 to 200 W Attenuators

The standard attenuators are foreseen for individual configuration. Four power levels from 25 W to 200 W are available. The connectors can be chosen from 7-16, 4.3-10 and N, either male or female. 4.3-10 male versions are available with screw, hand screw and push-pull version.

As special features, the attenuators can be ordered with an extended frequency range up to 6 GHz, with measurement protocol included in the delivery and integrated DC break. The individual configuration can be chosen by the sales article code on page 185.



Type 25



Type 50



Type 100



Type 200

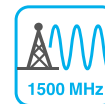

Version	Type 25	Type 50	Type 100	Type 200
Frequency range	0 - 4000 MHz (special feature up to 6000 MHz)			
Frequency range for attenuator with integrated DC break	100 - 4000 MHz (special feature up to 6000 MHz)			
VSWR	≤ 1.06 @ 0 – 1000 MHz ≤ 1.14 @ 1000 – 2000 MHz ≤ 1.20 @ 2000 – 3000 MHz ≤ 1.30 @ 3000 – 4000 MHz ( ≤ 1.40 @ 4000 – 6000 MHz )			
VSWR for attenuators with integrated DC break	≤ 1.70 @ 100 – 330 MHz ≤ 1.25 @ 330 – 694 MHz ≤ 1.20 @ 694 – 2690 MHz ≤ 1.30 @ 2690 – 3800 MHz ( ≤ 1.40 @ 5000 – 6000 MHz )			
Temperature range	-40 °C ... +40 °C			
Degree of protection	IP 50			
Weight	~ 0.6 kg	~ 0.9 kg	~ 1.1 kg	~ 2.7 kg

### Max. Input Power in Both Directions

Attenuation	3 dB	6 dB	10 dB	20 dB	30 dB	40 dB
Type 25	≤ 50 W	≤ 30 W	≤ 25 W	≤ 25 W	≤ 25 W	≤ 25 W
Type 50	≤ 100 W	≤ 65 W	≤ 50 W	≤ 50 W	≤ 50 W	≤ 50 W
Type 100	≤ 150 W	≤ 120 W	≤ 100 W	≤ 100 W	≤ 100 W	≤ 100 W
Type 200	≤ 300 W	≤ 200 W	≤ 200 W	≤ 200 W	≤ 200 W	≤ 200 W





## Attenuators

### Standard Attenuators - Article Codes

Please use article codes for inquiries and orders.

These are self explaining and enable you to specify a product without knowing its part number.

Attenuator	Power Dissipation		Connector 1	Connector 2		Attenuation	Extra Features
A	X	-	Z	X	-	Z	-X
25 W	25		Any combination of connectors below is possible				Leave blank if N/A
50 W	50						
100 W	100						
200 W	200						
7-16 male				7M			
7-16 female				7F			
4.3-10 male; screw				43MS			
4.3-10 male; hand screw				43MH			
4.3-10 male; push-pull				43MP			
4.3-10 female				43F			
N male				NM			
N female				NF			
3 dB						3	
6 dB						6	
10 dB						10	
20 dB						20	
30 dB						30	
40 dB						40	
Measurement protocol							P
Extended frequency range							E
DC break							D
Upgrade from IP 50 to IP 68 (outdoor capable)							O
Extended frequency range + measurement protocol							EP
DC break + measurement protocol							DP
Measurement protocol + IP 68							PO
Extended frequency range + IP 68							EO
DC break + IP 68							DO
Extended frequency range + measurement protocol + IP 68							EPO
DC break + measurement protocol + IP 68							DPO

#### Example of article codes:

**A25-7M43MH-10:** 10 dB attenuator with 25 W power dissipation and 7-16 male/4.3-10 male hand screw connectors.

**A200-NMNF-20-EP:** 20 dB attenuator with 200 W power dissipation and N male/N female connectors.

Ships with extended frequency range from DC to 6 GHz and measurement protocol.

## Attenuators

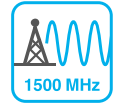
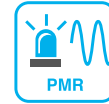

### Attenuators

Part Number	BN 534361	BN 534362	BN 534363	BN 534364
Frequency range	0 - 3000 MHz			
Attenuation	3 dB ± 0.2 dB	6 dB ± 0.2 dB	10 dB ± 0.3 dB	20 dB ± 0.5 dB
VSWR	≤ 1.04 @ 0 - 1000 MHz ≤ 1.08 @ 1000 - 2200 MHz ≤ 1.10 @ 2200 - 3000 MHz			
Power rating	≤ 10 W	≤ 6.5 W	≤ 5 W	≤ 5 W
Connectors	7-16 male / 7-16 female			
Temperature range	-40 °C ... +25 °C			
Degree of protection (mated)	IP 65			
Weight	~ 0.2 kg			



BN 534361

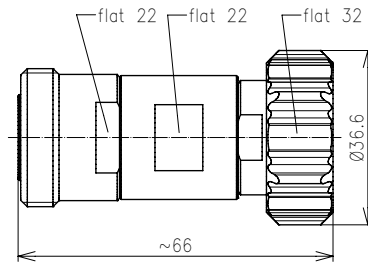

## Attenuators

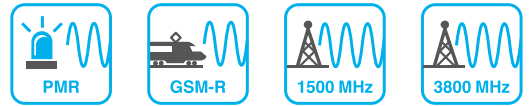

### Attenuators

Part Number	BN 528622	BN 528624	BN 528626	BN 528627
Frequency range	0 - 12400 MHz			
Attenuation	3 dB ± 0.3 dB	6 dB ± 0.4 dB	10 dB ± 0.5 dB	20 dB ± 1.0 dB
VSWR	≤ 1.15 @ 0 - 4000 MHz ≤ 1.27 @ 4000 - 8000 MHz ≤ 1.44 @ 8000 - 12400 MHz			
Power rating	≤ 10 W	≤ 6.5 W	≤ 5 W	≤ 5 W
Connectors	N male / N female			
Temperature range	-40 °C ... +25 °C			
Degree of protection (mated)	IP 40			
Weight	~ 0.1 kg			



**BN 528622**

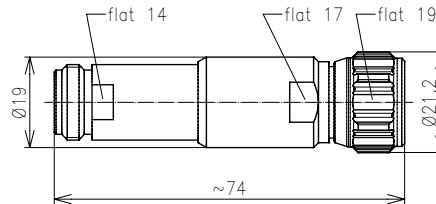

## Surge Protectors

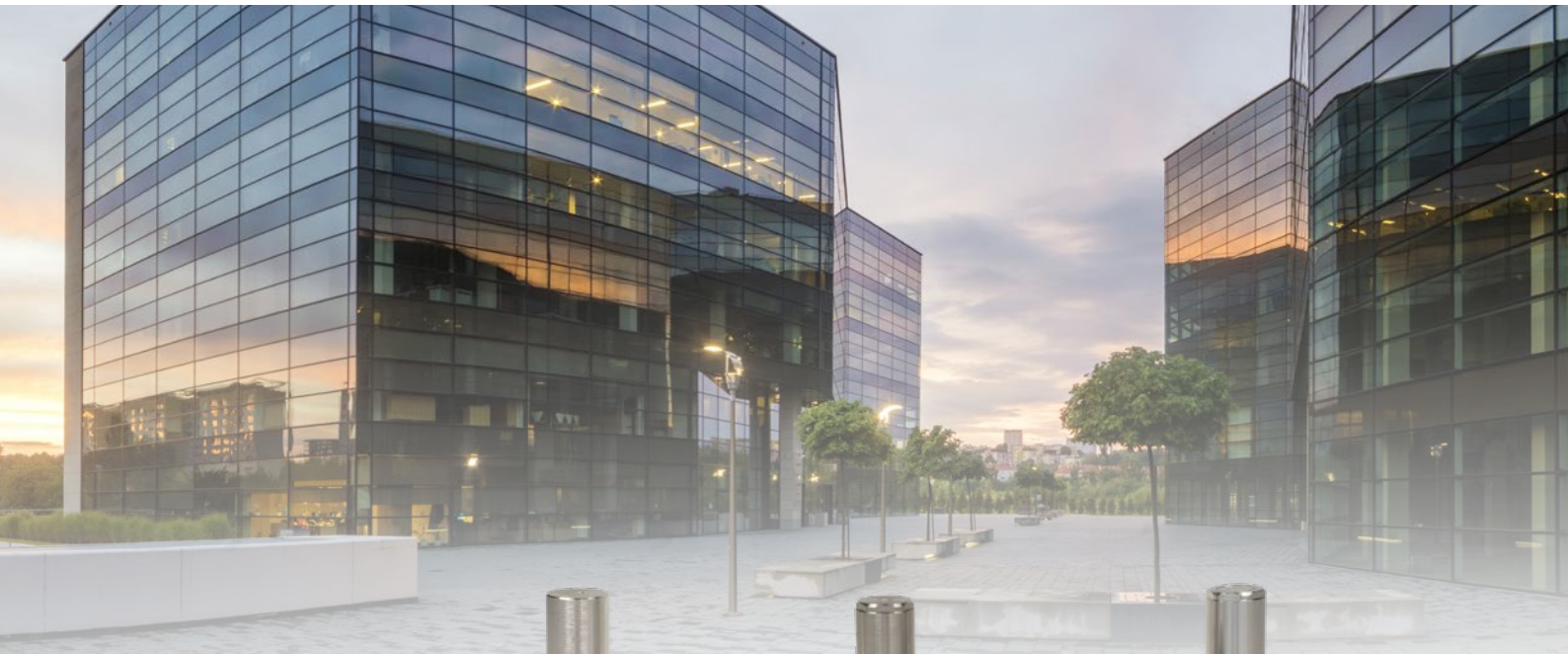

Surges are mainly caused by electromagnetic fields generated by nearby lightning strikes.

SPINNER offers a premium choice of different protection elements for coaxial systems. It covers all relevant RF applications for which a surge protection is necessary e.g.:

- The protection of installations for analog and digital communication such as 4m radio, VHF ground radio in aviation, 2m radio, TETRA, GSM900/1800, UMTS, LTE
- The protection of communication lines in tunnels
- The protection related to radiating cables

Version	Gas Discharge Arrestor (GDA)	Quarter Wavelength Stub (QWS)	Hybrid
<b>Application</b>	- Universal broadband - From 0 to 2500 MHz	- Up to 3 mobile bands - From 380 to 2200 MHz	- All mobile bands with active elements at the antenna
<b>Advantages</b>	- DC transmission possible	- No maintenance - High RF power rating - Very low intermodulation	- DC transmission possible - High RF power rating - Low intermodulation
<b>Remark</b>	- Maintenance required - Limited RF power - High intermodulation	- No DC transmission possible	- Maintenance required

## Surge Protectors – Technical Preface

### Gas discharge arrestor (GDA)

#### Construction:

A gas discharge arrestor consists of a cylindrical insulator (mostly ceramics) with conductive caps at the ends. The inside is filled with noble gas under defined pressure.

circuit symbol

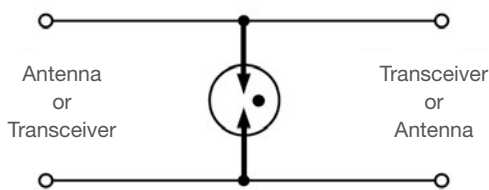

#### Function:

During normal operation the arrestor has a quasi-infinite resistance ( $> 1 \text{ G}\Omega$ ). If the voltage between the electrodes rises above the sparkover voltage, a breakthrough and discharge in the form of an electrical arc occurs. The sparkover voltage is dependent upon the rise time of the voltage and the type of arrestor. As the discharge is of low resistance the voltage between the electrodes is reduced to the arc (residual) voltage (typ. 20 V). The surge current can grow to very high values ( $\geq 25 \text{ kA}$ ) before the arrestor is destroyed. If the voltage between the electrodes falls below the arc voltage the arc extinguishes and the arrestor returns to normal operation.

### Quarter Wavelength Stub (QWS)

#### Construction:

A coaxial line with a defined characteristic nominal impedance is short-circuited at one end. The other end of the line with a length similar to a quarter wavelength is connected parallel to the main line.

circuit symbol

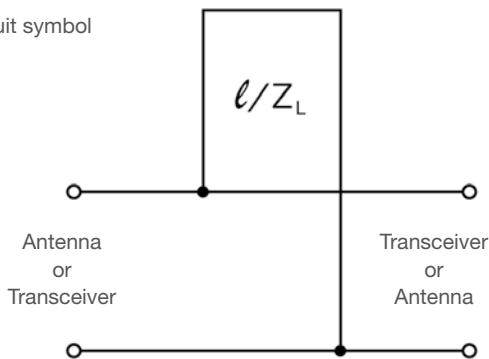

#### Function:

The short at the end of the stub is transformed to an open at the bottom. Thus the RF on the main line is inessentially influenced, and the stub acts like a simple band-pass filter with the quarter-wave frequency as centre frequency. The nature of the stub line (characteristic nominal impedance  $Z_L$  and length  $l$ ) together with additional transforming elements in the main line is responsible for the operating bandwidth of the device.

Because of the galvanic connection of inner and outer conductor, a DC transmission is not possible.

The missing of any non-linear component (e.g. a gas discharge arrestor) secures very low intermodulation.

The stub can be orthogonal to or folded into the axis of the main line (in-line design).

### Hybrid – with Quarter Wavelength Stub and Gas Discharge Arrestor

The Hybrid type combines both protection mechanisms. The short at the end of the  $\lambda/4$  line is replaced by a capacity and a gas discharge arrestor. The inner and outer conductor of the main line are not connected galvanically, therefore DC and low frequency can be transmitted. The main line is decoupled from the effects of the arrestor and vice versa by the quarter wavelength line. Thus the arrestor is free of electrical stress in normal operation.

## Surge Protectors – Gas Discharge Arrestors

Surge protectors with gas discharge arrestors can be used for all applications in the frequency range of 0 to 2.5 GHz. The RF power rating is limited by the sparkover voltage of the discharge arrestor.

- Symmetrical design (both sides protected)
- Suitable for outdoor installation
- DC transmission via inner conductor possible
- Gas discharge arrestor easily replaceable
- Replacement recommended every 3 to 4 years
- Arrestors free of radioactivity

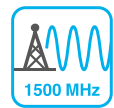
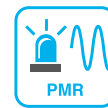

### Housings for Gas Discharge Arrestors

Part Number	BN 194284	BN 920480	BN 950880	BN 950888
Frequency range	0 - 2500 MHz			
Insertion loss	≤ 0.1 dB			
Passive intermodulation (IM3) @ 2 x 20 W	N/A			
VSWR	≤ 1.06 @ 0 - 1000 MHz ≤ 1.20 @ 1000 - 2500 MHz			
Connectors	7-16 male / 7-16 female bulkhead	7-16 female / 7-16 female bulkhead	N male / N female bulkhead	N female / N female bulkhead
Temperature range	-40 °C ... +85 °C			
Degree of protection (mated)	IP 67			
Weight	~ 270 g	~ 280 g	~ 160 g	~ 130 g
Grounding cable	BN A71367			

### Gas Discharge Arrestors

Part Number	BN A71307	BN A71308	BN A71311	BN A71313
Stat. sparkover voltage (100 V/s)	90 V ± 20 V	230 V ± 35 V	600 +120 V / -90 V	1000 V ± 200 V
Power rating	≤ 20 W	≤ 180 W	≤ 1200 W	≤ 3000 W
Dyn. sparkover voltage (1 kV/μs)	≤ 700 V	≤ 750 V	≤ 1200 V	≤ 1600 V
Surge current	≤ 25 kA			
Single (8/20 μs)				
multiple (8/20 μs) 5 pulses in 3 min.	≤ 20 kA	≤ 10 kA	≤ 10 kA	≤ 5 kA
Arc (residual) voltage	≤ 25 V			≤ 30 V

A reliable protection against surges is given only by a proper installation and regular maintenance depending on the protector type. The maintenance intervals depend mainly upon the number and the strength of the impulse current impacts.

## Surge Protectors – Gas Discharge Arrestors

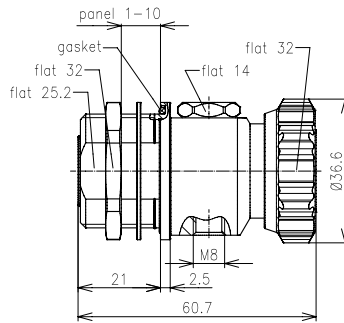

**BN 194284**

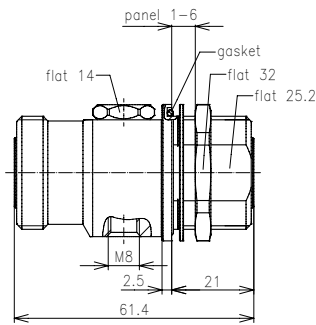

**BN 920480**

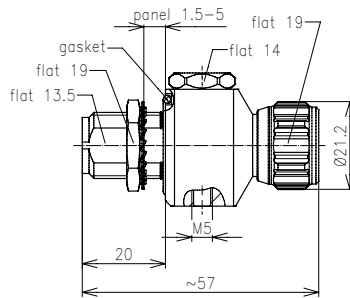

**BN 950880**

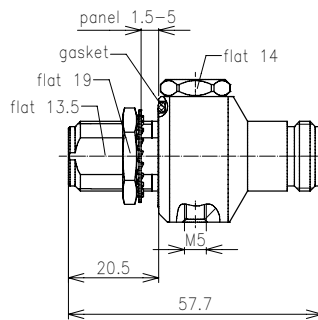

**BN 950888**

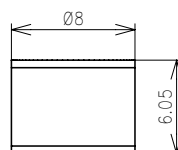

**BN A71307**

## Surge Protectors – Quarter Wavelength Stubs

This kind of surge protector is suitable for applications with single or multiple combined mobile communication bands (e.g. GSM900, GSM1800 and UMTS). DC transmission via the coaxial ports is not possible with this type.

- Symmetrical design, both sides protected
- High RF power rating
- Very low intermodulation
- Suitable for outdoor installation
- Maintenance free

The stub can be orthogonal to or folded into the axis of the main line (in-line design).

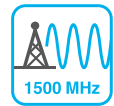

Part Number	BN 766419	BN 756473	BN 756474
Frequency range	380 - 512 MHz	800 - 2170 MHz	
Insertion loss	≤ 0.1 dB		
Surge current (8/20 μs)	≤ 50 kA	≤ 60 kA	
Test pulse	4 kV (1.2/50 μs) and 2 kA (8/20 μs)		
Residual energy at test pulse	≤ 20 μJ	≤ 7 μJ	
Passive intermodulation (IM3) @ 2 x 20 W	N/A	≤ -160 dBc	
VSWR	≤ 1.22	≤ 1.11	
Power rating	≤ 3 kW	≤ 0.95 kW @ 800 MHz ≤ 0.60 kW @ 2170 MHz	
Connectors	7-16 male / 7-16 female		7-16 female / 7-16 female
Temperature range	-40 °C ... +75 °C	-40 °C ... +85 °C	
Degree of protection (mated)	IP 67		
Weight	~ 430 g	~ 500 g	~ 450 g
Grounding cable	<b>BN A71367</b>	Included	



## Surge Protectors – Quarter Wavelength Stubs



BN 766419

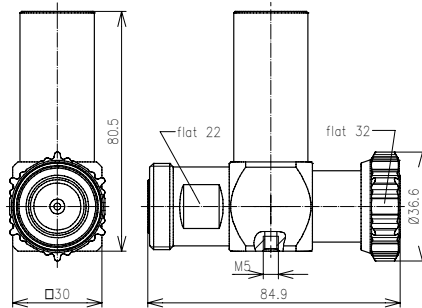

BN 756473

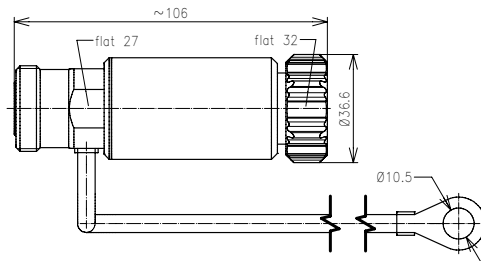

BN 756474

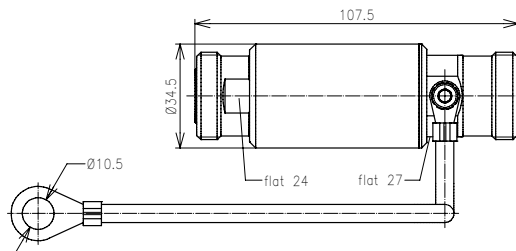

### Accessory



BN A71367

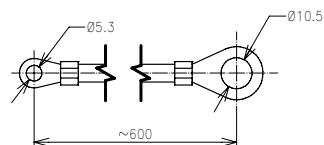

Grounding cable length: 600 mm.  
Ground lead Li2Y 1x6 mm<sup>2</sup> with crimped ground lugs for M5/M8 screws.

## Surge Protectors – Hybrid Protectors with Quarter Wavelength Line and Gas Discharge Arrestor

This surge protector design combines the advantages of both protection techniques (DC transmission and low intermodulation). Therefore, it is also called a hybrid design.

The bandwidth is 678 MHz to 2700 MHz and 0 to 10 MHz (for AISG). Suitable for DC and low frequency (LF) transmission these surge protectors can also be used to transmit control signals (according to AISG) of antenna amplifiers and/or remote controlled antennas.

- Symmetrical design (both sides protected)
- Broadband low VSWR
- High RF power rating
- High DC voltage and current rating
- Very low intermodulation
- Arrestor free of radioactivity
- Arrestor easy to replace
- Recommended replacement every 8 to 10 years
- Suitable for outdoor installation

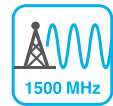

Part Number	BN 766471	BN 766475	BN 432900	BN 432901
Frequency range	678 - 2700 MHz			
Insertion loss	≤ 0.1 dB			
Surge current (8/20 µs)	≤ 30 kA (single) ≤ 20 kA (multiple)			
Test pulse	4 kV (1.2/50 µs) and 2 kA (8/20 µs)			
Residual energy at test pulse	≤ 350 µJ			
Stat. sparkover voltage of the gas discharge arrestor	90 V ± 20 V			
Passive intermodulation (IM3) @ 2 x 20 W	≤ -160 dBc			
VSWR	≤ 1.25 @ 678 - 694 MHz ≤ 1.20 @ 694 - 725 MHz ≤ 1.15 @ 725 - 2675 MHz ≤ 1.20 @ 2675 - 2700 MHz			
Power rating	≤ 2.7 kW @ 678 MHz ≤ 1.3 kW @ 2700 MHz		≤ 850 W @ 694 MHz ≤ 430 W @ 2700 MHz	
DC and AISG	≤ 60 V (≤ 10 A)			
Connectors	7-16 female / 7-16 female bulkhead	7-16 male / 7-16 female bulkhead	4.3-10 male screw type / 4.3-10 female bulkhead	4.3-10 female/ 4.3-10 female bulkhead
Temperatur range	-40 °C ... +85 °C			
Degree of protection (mated)	IP 67			
Weight	~ 400 g		~ 350 g	
Spare arrestor	<b>BN A72245</b>			

## Surge Protectors – Hybrid Protectors with Quarter Wavelength Line and Gas Discharge Arrestor



BN 766471

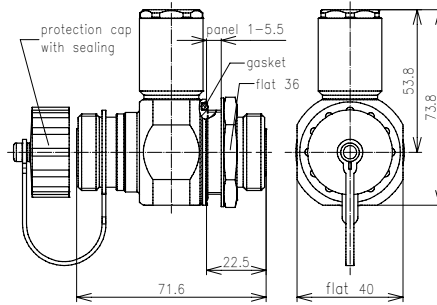

BN 766475

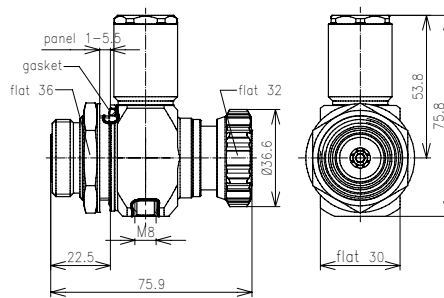

BN 432900

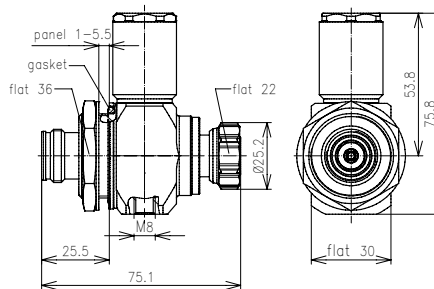

BN 432901

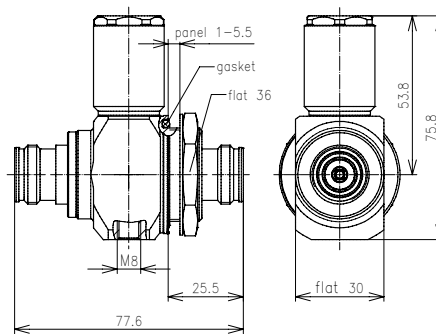

BN A72245

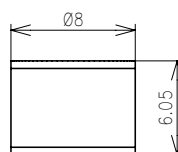

## DC Breaks



**DC breaks prevent the propagation of direct current or of signals with low transmission frequencies while allowing RF transmission to proceed smoothly at the same time.**

SPINNER delivers two types of DC breaks:

- Types with open inner conductor only: They are mainly used for shielding antennas or ground stations from low-frequency signals deliberately fed in for controlling mobile communication antennas or for the power supply of tower mounted amplifiers.
- Types with open inner and outer conductor: They are mainly used for preventing undesirable induced voltage, in communication equipment, e.g. radiating cables. Inducted voltages are generated by e.g. high power lines in underground train systems.



**BN 756486**

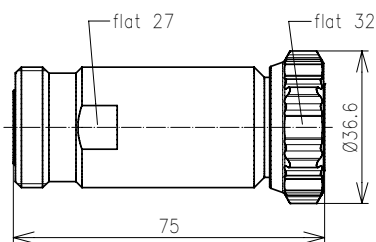

**BN 432054**

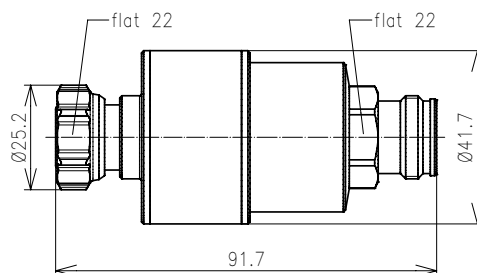

## DC Breaks



Part Number	BN 756486	BN 432065
Version	Inner conductor separated	
Frequency range	670 - 2700 MHz	
Insertion loss	≤ 0.10 dB	
Passive intermodulation (IM3) @ 2 x 20 W	≤ -160 dBc; typ. ≤ -165 dBc	
VSWR	≤ 1.25 @ 670 - 800 MHz ≤ 1.16 @ 800 - 2500 MHz ≤ 1.25 @ 2500 - 2700 MHz	
Power rating	≤ 800 W @ 698 MHz ≤ 400 W @ 2700 MHz	
Temperature range	-40 °C ... +55 °C	
Degree of protection (mated)	IP 68	
Connectors	7-16 male / 7-16 female	4.3-10 male screw type / 4.3-10 female
Weight	~ 0.3 kg	
Blocking DC voltage	≤ 1000 V	

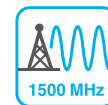

Part Number	BN 766436	BN 766438	BN 432054	BN 432067	BN 950720	BN 950721
Version	Inner and outer conductor separated	Inner conductor separated	Inner and outer conductor separated	Inner conductor separated	Inner and outer conductor separated	Inner conductor separated
Frequency range	80 - 3800 MHz *)					
Insertion loss	≤ 0.25 dB; typ. ≤ 0.10 dB					
Passive intermodulation (IM3) @ 2 x 20 W	≤ -160 dBc; typ. ≤ -165 dBc				≤ -155 dBc; typ. ≤ -160 dBc	
VSWR	≤ 1.40; typ. ≤ 1.28 @ 80 - 100 MHz ≤ 1.30; typ. ≤ 1.22 @ 100 - 300 MHz ≤ 1.10; typ. ≤ 1.06 @ 300 - 1880 MHz ≤ 1.20; typ. ≤ 1.11 @ 1880 - 2700 MHz ≤ 1.25; typ. ≤ 1.19 @ 2700 - 3800 MHz					
Power rating	1500 W @ 80 MHz 300 W @ 1880 MHz 250 W @ 2700 MHz 130 W @ 3800 MHz					
Temperature range	-40 °C ... +55 °C					
Degree of protection (mated)	IP 67					
Connectors	7-16 male / 7-16 female		4.3-10 male screw type / 4.3-10 female		N male / N female	
Weight	~ 0.3 kg					
Blocking DC voltage	3000 V					

\*) All DC Breaks can be made available with extended frequency range from 33 - 4000 MHz + 5000 - 6000 MHz. For ordering, please add suffix F001 to above shown part numbers (e.g. BN 766436F001).

## Tools and Accessories



### SPINNER Plast2000

SPINNER Plast2000 guarantees a perfect sealing function and corrosion protection between connector and cable.

Product	Part Number
20 cm <sup>3</sup> tube, screws directly into the cable entries	<b>BN 151671</b>
70 cm <sup>3</sup> tube, to be squeezed into injection gun <b>BN 070551</b>	<b>BN 150597</b>
150 ml injection gun, screws directly into the cable entries	<b>BN 070551</b>



**BN 151671**



**BN 150597**



**BN 070551**

### Trimming Tools

- Assembly time cut by more than 60%
- Considerable reduction of assembly costs
- Constant assembly quality

Cable Type	Version	Part Number
SF 1/4"-50	CAF®	<b>BN 541328</b>
SF 3/8"-50	CAF®	<b>BN 541335</b>
SF 1/2"-50	CAF®	<b>BN 541334</b>
SF 1/2"-50	MultiFit	<b>BN 541354</b>
LF 1/4"-50	CAF®	<b>BN 541320</b>
LF 3/8"-50	CAF®	<b>BN 541338</b>
LF 1/2"-50	CAF®	<b>BN 541317</b>
LF 1/2"-50	MultiFit	<b>BN 541387</b>
LF 7/8"-50	CAF®	<b>BN 541318</b>
LF 7/8"-50	MultiFit	<b>BN 541301</b>
UCF114-50A LCF158-50A LCF214-50A	Economy type	<b>BN 541343</b>
1 1/4"* 1 5/8"*	Comfort type	<b>BN 541346</b>



**BN 541354**



**BN 541343**



**BN 541346**

\* For all annularly corrugated foam and radiating cables

## Tools and Accessories

### Torque Wrenches

During connector installation, the back nut has to be tightened to the connector body. The best possible result can be achieved by using a torque wrench. SPINNER offers a choice of torque wrenches for SPINNER MultiFit® connectors.

Cable Type / Version	Wrench Size mm	Torque Nm	Part Number
SF 1/2" / MultiFit	17	25	BN 238734
LF 1/2" / MultiFit	22	25	BN 238735
LF 7/8" / MultiFit	32	30	BN 238736
LF 1 1/4" and LF 1 5/8" / MultiFit	32	60	BN 238737



BN 238736

SPINNER offers a choice of torque wrenches to support connector mating.

Connector Style	Wrench Size mm	Torque Nm	Part Number
7-16 male	32	30	BN 238736
4.3-10 male screw type	22	5	BN 238739
N male	19	3	BN 238738
2.2-5 male screw type	16	3	BN 238742



BN 238739

### Poly Hook Spanner

For the assembly of connectors to LF 1 1/4", LF 1 5/8" and LF 2 1/4" coaxial cables, we recommend poly hook spanners with 5 mm pin for outer diameters of 48 to 90 mm.

Tool Type	Pin mm	Outer diameters mm	Part Number
Poly hook spanner	5	48-90	BN 071551



BN 071551

## Tools and Accessories

### Protective Caps

#### For Connector Type 7-16



**BN 239002**

For 7-16 male connectors  
(brass – with chain)



**BN 239004 \*)**

For 7-16 male connectors  
(plastic)



**BN 238950**

For 7-16 female connectors  
(brass – with chain)



**BN 238904 \*)**

For 7-16 female connectors  
(plastic)

\*) Once stock with black caps is cleared, new versions will be blue.

#### For Connector Type 4.3-10



**BN 239021**

For 4.3-10 male connectors  
(brass)



**BN 239020**

For 4.3-10 male connectors  
(brass – with chain)



**BN 239043**

For 4.3-10 male connectors  
(plastic)



**BN 238921**

For 4.3-10 female connectors  
(brass)



**BN 238920**

For 4.3-10 female connectors  
(brass – with chain)



**BN 238943**

For 4.3-10 female connectors  
(plastic)

#### For Connector Type N



**BN 998800**

For N male connectors  
(brass – with chain)



**BN 296300**

For N female connectors  
(brass – with chain)



## Tools and Accessories

### Grounding Kits

SPINNER FlexGround is available for different cable types. For cable stripping tools, please see below.

Cable Type	Part Number
LF 1/2" - 50	BN A73258
LF 7/8" - 50	BN A73259
LF 1 1/4" - 50	BN A73260
LF 1 5/8" - 50	BN A73261



BN A73259

### Jacket Stripping Tools

To connect a grounding kit, first use an appropriate stripping tool to remove a short section of the cable jacket.

Cable Type	Part Number
LF 1/2" - 50	BN A73233
LF 7/8" - 50	BN A73234
LF 1 1/4" - 50	BN A73235
LF 1 5/8" - 50	BN A73236



BN A73234

### Cable Clamps

The SPINNER FlexFix cable clamps are suitable for C-rail.

Cable Type	Part Number for 1 Cable	Part Number for 2 Cables	Part Number for 3 Cables
LF 1/2" - 50	A73243C0001	A73244C0001	A73245C0001
LF 7/8" - 50	A73246C0001	A73242C0001	A73247C0001
LF 1 1/4" - 50	A73248C0001	A73249C0001	A73250C0001
LF 1 5/8" - 50	A73251C0001	A73252C0001	A73253C0001



A73246C0001



A73242C0001



A73247C0001



## Index

Part Number	Page	Part Number	Page	Part Number	Page
A73028 *	72	BN 225019	60	BN 419400	42
A73029 *	72	BN 225020	60	BN 420100	20
A73030 *	72	BN 225021	60	BN 420100	42
A73037 **	72	BN 225026	47	BN 431002	26
A73038 **	72	BN 225027	47	BN 431017	25
A73088 *	72	BN 225035	46	BN 431020	27
A73088 *	72	BN 225036	46	BN 431022	27
A73090 **	72	BN 225038	46	BN 431040	26
A73091 **	72	BN 225039	46	BN 431068	25
A73151 *	72	BN 225040	46	BN 431100	24
A73242C0001	201	BN 225044	47	BN 431101	24
A73243C0001	201	BN 225045	47	BN 431102	26
A73244C0001	201	BN 225046	47	BN 431103	24
A73245C0001	201	BN 225047	47	BN 431104	24
A73246C0001	201	BN 238734	199	BN 431105	24
A73247C0001	201	BN 238735	199	BN 431106	24
A73248C0001	201	BN 238736	199	BN 431107	24
A73249C0001	201	BN 238737	199	BN 431108	24
A73250C0001	201	BN 238738	199	BN 431109	24
A73251C0001	201	BN 238739	199	BN 431110	24
A73252C0001	201	BN 238742	199	BN 431111	24
A73253C0001	201	BN 238904 *)	200	BN 431112	24
BN 070551	198	BN 238920	200	BN 431113	24
BN 071551	199	BN 238921	200	BN 431114	24
BN 150597	198	BN 238943	200	BN 431115	25
BN 151671	198	BN 238950	200	BN 431116	25
BN 194284	190	BN 239002	200	BN 431117	25
BN 194400	50	BN 239004 *)	200	BN 431118	25
BN 196400	57	BN 239020	200	BN 431119	25
BN 225002	51	BN 239021	200	BN 431120	27
BN 225003	51	BN 239043	200	BN 431121	25
BN 225006	51	BN 293650	59	BN 431122	27
BN 225008	51	BN 293750	59	BN 431123	26
BN 225009	53	BN 293800	50	BN 431124	26
BN 225010	53	BN 293900	50	BN 431125	27
BN 225012	53	BN 294000	50	BN 431126	27
BN 225013	53	BN 296300	200	BN 431127	27
BN 225014	55	BN 296400	57	BN 431128	27
BN 225015	55	BN 296650	41	BN 431129	28
BN 225016	55	BN 299750	59	BN 431130	28
BN 225017	55	BN 393370	57	BN 431131	28
BN 225018	60	BN 419400	20	BN 431133	26



## Index

Part Number	Page	Part Number	Page	Part Number	Page
BN 431140	26	BN 432035	58	BN 541317	198
BN 431168	25	BN 432049	58	BN 541318	198
BN 431171	24	BN 432050	58	BN 541320	198
BN 431174	24	BN 432054	197	BN 541328	198
BN 431403	29	BN 432055	58	BN 541334	198
BN 431404	29	BN 432065	197	BN 541335	198
BN 431405	29	BN 432067	197	BN 541338	198
BN 431406	29	BN 432900	195	BN 541343	198
BN 431500	29	BN 432901	195	BN 541346	198
BN 431501	29	BN 433000	143	BN 541354	198
BN 431502	29	BN 433001	143	BN 541387	198
BN 431503	29	BN 433002	143	BN 547700	182
BN 432001	49	BN 433003	142	BN 547720	181
BN 432002	49	BN 433004	142	BN 557110	40
BN 432003	52	BN 433005	142	BN 557111	40
BN 432004	52	BN 450940	42	BN 557150	40
BN 432005	49	BN 450995	20	BN 557151	40
BN 432007	49	BN 527751	181	BN 557152	18
BN 432008	49	BN 527755	181	BN 557153	18
BN 432009	52	BN 527757	181	BN 557161	40
BN 432010	52	BN 528622	187	BN 557163	18
BN 432011	49	BN 528624	187	BN 557171	40
BN 432015	49	BN 528626	187	BN 557173	18
BN 432016	49	BN 528627	187	BN 570510	94
BN 432017	58	BN 531221	180	BN 570511	94
BN 432018	58	BN 531225	180	BN 570512	94
BN 432019	58	BN 531227	180	BN 570513	94
BN 432020	54	BN 531702	180	BN 570528	101
BN 432021	54	BN 531712	180	BN 570531	133
BN 432022	54	BN 531726	180	BN 570538	121
BN 432023	54	BN 531727	180	BN 570552	81
BN 432024	52	BN 534267	177	BN 570554	81
BN 432025	52	BN 534268	176	BN 570561	133
BN 432026	54	BN 534276	172	BN 570568	83
BN 432027	54	BN 534277	171	BN 570569	83
BN 432028	58	BN 534279	171	BN 570571	84
BN 432029	58	BN 534280	171	BN 570572	84
BN 432030	52	BN 534361	186	BN 570573	84
BN 432031	52	BN 534362	186	BN 570574	84
BN 432032	54	BN 534363	186	BN 570611	133
BN 432033	54	BN 534364	186	BN 570612	133
BN 432034	58	BN 541301	198	BN 570613	133



## Index

Part Number	Page	Part Number	Page	Part Number	Page
BN 570614	133	BN 570723	104	BN 572656	102
BN 570615	133	BN 570732	89	BN 572657	102
BN 570616	133	BN 570733	118	BN 572658	102
BN 570626	133	BN 570734	106	BN 572659	102
BN 570627	133	BN 570735	106	BN 572660	125
BN 570630	133	BN 570736	106	BN 572661	124
BN 570631	133	BN 570737	106	BN 572662	130
BN 570633	117	BN 570738	106	BN 572663	129
BN 570634	121	BN 570739	106	BN 572664	99
BN 570635	117	BN 570741	120	BN 572665	99
BN 570637	90	BN 570742	121	BN 572666	99
BN 570638	90	BN 570744	92	BN 572667	99
BN 570643	133	BN 570747	105	BN 572668	88
BN 570644	133	BN 570748	105	BN 572669	88
BN 570656	121	BN 570749	105	BN 572670	91
BN 570657	121	BN 570750	105	BN 572671	91
BN 570662	133	BN 570752	133	BN 572672	91
BN 570663	133	BN 570753	133	BN 572673	91
BN 570665	133	BN 570754	116	BN 572674	88
BN 570668	83	BN 570755	119	BN 572677	88
BN 570672	84	BN 570756	89	BN 572679	128
BN 570673	133	BN 572610	100	BN 572680	109
BN 570674	84	BN 572611	100	BN 572681	122
BN 570680	119	BN 572612	100	BN 572682	122
BN 570680F001	119	BN 572613	100	BN 572683	122
BN 570681	120	BN 572620	101	BN 572684	123
BN 570682	120	BN 572621	101	BN 572685	126
BN 570683	120	BN 572622	101	BN 572686	127
BN 570684	118	BN 572638	95	BN 572687	126
BN 570685	118	BN 572639	95	BN 572688	126
BN 570690	127	BN 572640	95	BN 572689	128
BN 570691	107	BN 572641	95	BN 572690	131
BN 570692	107	BN 572642	108	BN 572691	110
BN 570698	107	BN 572643	108	BN 572692	110
BN 570699	107	BN 572646	108	BN 572924	93
BN 570702	103	BN 572647	108	BN 573189	90
BN 570703	103	BN 572648	96	BN 573191	90
BN 570704	103	BN 572649	96	BN 573621	101
BN 570705	103	BN 572650	96	BN 573622	101
BN 570720	104	BN 572651	96	BN 573640	98
BN 570721	104	BN 572654	102	BN 573641	98
BN 570722	104	BN 572655	102	BN 573642	98



## Index

Part Number	Page	Part Number	Page	Part Number	Page
BN 573643	98	BN 616439	82	BN 745408	183
BN 573645	114	BN 616499	78	BN 745409	183
BN 576115	97	BN 640680	56	BN 747544	35
BN 576116	97	BN 640681	56	BN 747645	34
BN 576117	97	BN 640682	56	BN 753348	161
BN 576118	97	BN 640683	56	BN 753349	161
BN 594272	173	BN 654302	15	BN 753352	161
BN 594273	173	BN 654317	13	BN 753353	161
BN 594274	173	BN 654320	15	BN 753355	161
BN 594275	173	BN 654322	16	BN 753356	161
BN 594276	174	BN 655640	14	BN 753357	159
BN 594278	174	BN 655641	14	BN 753358	159
BN 594282	175	BN 655642	15	BN 753359	159
BN 594283	175	BN 655644	16	BN 753360	161
BN 594284	175	BN 655663	17	BN 753361	162
BN 594285	175	BN 655673	17	BN 753362	162
BN 610003	81	BN 706402	37	BN 753363	162
BN 610007	79	BN 706416	35	BN 753364	162
BN 610011	83	BN 706417	35	BN 753365	162
BN 610013	84	BN 706420	38	BN 753366	162
BN 610014	84	BN 706422	39	BN 753367	114
BN 610015	79	BN 706740	37	BN 753368	160
BN 610017	79	BN 706741	37	BN 753369	160
BN 610630	125	BN 706742	38	BN 753373	115
BN 610631	124	BN 706744	39	BN 753374	115
BN 610632	122	BN 708250	59	BN 753381	158
BN 610633	122	BN 710339	10	BN 753382	158
BN 610634	122	BN 710359	11	BN 753383	158
BN 610635	123	BN 710368	13	BN 753386	158
BN 610647	130	BN 710371	11	BN 753388	115
BN 610648	129	BN 710389	13	BN 753390	163
BN 610649	126	BN 721280	41	BN 753391	163
BN 610650	126	BN 721283	41	BN 756404	57
BN 610651	128	BN 741445	12	BN 756473	192
BN 610652	126	BN 741460	10	BN 756474	192
BN 616313	80	BN 745401	183	BN 756486	196
BN 616314	80	BN 745402	183	BN 757855	34
BN 616331	82	BN 745403	183	BN 757860	32
BN 616396	78	BN 745404	183	BN 766419	192
BN 616398	78	BN 745405	183	BN 766436	197
BN 616430	77	BN 745406	183	BN 766438	197
BN 616431	77	BN 745407	183	BN 766471	195



## Index

Part Number	Page	Part Number	Page	Part Number	Page
BN 766475	195	BN 818356	155	BN 818464	151
BN 807621	18	BN 818357	155	BN 818465	151
BN 807625	18	BN 818358	155	BN 844755	34
BN 807680	18	BN 818359	155	BN 844760	32
BN 807706	18	BN 818360	155	BN 844840	14
BN 807733	18	BN 818361	155	BN 844841	14
BN 807750	18	BN 818362	155	BN 844842	15
BN 807752	18	BN 818366	155	BN 844844	16
BN 807788	18	BN 818399	149	BN 844850	14
BN 808450	57	BN 818431	153	BN 844851	14
BN 818242	148	BN 818432	153	BN 844863	17
BN 818243	148	BN 818433	153	BN 844873	17
BN 818244	148	BN 818434	153	BN 845555	34
BN 818245	148	BN 818435	153	BN 845560	32
BN 818246	148	BN 818436	153	BN 846057	33
BN 818248	148	BN 818437	153	BN 846063	32
BN 818249	148	BN 818438	153	BN 846068	36
BN 818257	147	BN 818439	153	BN 846069	34
BN 818263	144	BN 818440	152	BN 846071	33
BN 818264	144	BN 818441	152	BN 846089	36
BN 818265	144	BN 818442	152	BN 846340	37
BN 818266	145	BN 818443	152	BN 846341	37
BN 818267	145	BN 818444	152	BN 846342	38
BN 818268	145	BN 818445	152	BN 846344	39
BN 818269	141	BN 818446	152	BN 846402	37
BN 818273	141	BN 818447	152	BN 846417	36
BN 818274	141	BN 818448	152	BN 846420	38
BN 818289	138	BN 818449	154	BN 846422	39
BN 818290	138	BN 818450	154	BN 847339	10
BN 818291	138	BN 818451	154	BN 847356	13
BN 818292	139	BN 818452	154	BN 847357	11
BN 818293	139	BN 818453	154	BN 847359	11
BN 818294	139	BN 818454	154	BN 847368	13
BN 818299	148	BN 818455	154	BN 847369	12
BN 818342	149	BN 818456	154	BN 847371	11
BN 818343	149	BN 818457	154	BN 847373	10
BN 818344	149	BN 818458	151	BN 847374	11
BN 818345	149	BN 818459	151	BN 847389	13
BN 818346	149	BN 818460	151	BN 847391	13
BN 818348	149	BN 818461	151	BN 854302	14
BN 818349	149	BN 818462	151	BN 854309	14
BN 818355	155	BN 818463	151	BN 854316	13



## Index

Part Number	Page	Part Number	Page	Part Number	Page
BN 854317	13	BN 923062	157	BN 982900	42
BN 854320	15	BN 923063	146	BN 982911	20
BN 854322	16	BN 923064	146	BN 982911	42
BN 870156	33	BN 923065	146	BN 998800	200
BN 870157	33	BN 923066	157	BN A71307	190
BN 870163	32	BN 923067	143	BN A71308	190
BN 870165	32	BN 923068	143	BN A71311	190
BN 870167	35	BN 923069	143	BN A71313	190
BN 870168	35	BN 923070	164	BN A71367	192
BN 870169	34	BN 923071	157	BN A72245	195
BN 870170	34	BN 923075	164	BN A73233	201
BN 870171	33	BN 923076	164	BN A73234	201
BN 870173	32	BN 923083	160	BN A73235	201
BN 870174	33	BN 923089	140	BN A73236	201
BN 870187	35	BN 923090	140	BN A73258	201
BN 870189	35	BN 923091	140	BN A73259	201
BN 920480	190	BN 923099	150	BN A73260	201
BN 922450	41	BN 941510	50	BN A73261	201
BN 922475	41	BN 941610	50	BN A77136	167
BN 922550	41	BN 941710	50	BN A77137	169
BN 923001	156	BN 941810	50	BN A77138	167
BN 923003	156	BN 944702	57	BN A77139	167
BN 923006	156	BN 944950	59	BN A77140	167
BN 923007	156	BN 944951	59	BN A77141	168
BN 923008	156	BN 945060	41	BN A77142	169
BN 923009	156	BN 945061	41	BN A77143	169
BN 923012	156	BN 950720	197	BN A77144	168
BN 923013	156	BN 950721	197	BN A77145	168
BN 923014	156	BN 950880	190	BN A77146	169
BN 923042	150	BN 950888	190	BN A77147	169
BN 923043	150	BN 950890	59	BN A77148	169
BN 923044	150	BN 951820	18	BN A77149	167
BN 923045	150	BN 951920	18		
BN 923046	150	BN 954510	21		
BN 923048	150	BN 954684	21		
BN 923049	150	BN 954716	21		
BN 923056	157	BN 954765	21		
BN 923057	157	BN 955250	55		
BN 923058	157	BN 955350	55		
BN 923059	157	BN 955450	55		
BN 923060	157	BN 955550	55		
BN 923061	157	BN 982900	20		



Notes

A large rectangular area with horizontal grey lines, intended for taking notes.







## HIGH FREQUENCY PERFORMANCE WORLDWIDE

SPINNER designs and builds cutting-edge radio frequency systems, setting performance and longevity standards for others to follow. The company's track record of innovation dates back to 1946, and many of today's mainstream products are rooted in SPINNER inventions.

Industry leaders continue to count on SPINNER's engineering excellence to drive down their costs of service and ownership with premium-quality, off-the-shelf products and custom solutions. Headquartered in Munich, Germany, the global frontrunner in RF components remains the first choice in simple-yet-smart RF solutions.

[www.spinner-group.com](http://www.spinner-group.com)

### **SPINNER GmbH**

#### **Headquarters**

Erzgiessereistr. 33  
80335 Munich

#### **GERMANY**

Phone: +49 89 12601-0  
Fax: +49 89 12601-1292  
[info@spinner-group.com](mailto:info@spinner-group.com)

### **SPINNER Austria GmbH**

Triester Str. 190  
1230 Vienna

#### **AUSTRIA**

Phone: +43 1 66277 51  
Fax: +43 1 66277 5115  
[info-austria@spinner-group.com](mailto:info-austria@spinner-group.com)

### **SPINNER Electrotécnica S.L.**

c/ Perú, 4 – Local nº 15  
28230 Las Rozas (Madrid)

#### **SPAIN**

Phone: +34 91 6305 842  
Fax: +34 91 6305 838  
[info-iberia@spinner-group.com](mailto:info-iberia@spinner-group.com)

### **OOO SPINNER Elektrotechnik**

Kozhevnikeskaja str. 1, bld. 1  
Office 420  
115114 Moscow

#### **RUSSIA**

Phone: + 7 495 638 5321  
Fax: +7 495 240 5889  
[info-russia@spinner-group.com](mailto:info-russia@spinner-group.com)

### **SPINNER France S.A.R.L.**

24 Rue Albert Priolet  
78100 St. Germain en Laye

#### **FRANCE**

Phone: +33 1 74 13 85 24  
[info-france@spinner-group.com](mailto:info-france@spinner-group.com)

### **SPINNER ICT Inc.**

2220 Northmont Parkway, 250  
Duluth, GA 30096

#### **USA**

Phone: +1 770 2636 326  
[info@spinner-group.com](mailto:info@spinner-group.com)

### **SPINNER Nordic AB**

Kråketorpsgatan 20  
43153 Mölndal

#### **SWEDEN**

Phone: +46 31 7061670  
Fax: +46 31 7061679  
[info-nordic@spinner-group.com](mailto:info-nordic@spinner-group.com)

### **SPINNER Telecommunication**

Devices (Shanghai) Co., Ltd.  
351 Lian Yang Road  
Songjiang Industrial Zone  
Shanghai 201613

#### **P.R. CHINA**

Phone: +86 21 577 45377  
Fax: +86 21 577 40962  
[info-china@spinner-group.com](mailto:info-china@spinner-group.com)

### **SPINNER UK Ltd.**

Suite 8 Phoenix House  
Golborne Enterprise Park,  
High Street  
Golborne, Warrington  
WA3 3DP

#### **UNITED KINGDOM**

Phone: +44 1942 275222  
Fax: +44 1942 275221  
[info-uk@spinner-group.com](mailto:info-uk@spinner-group.com)